

2012-2013 Academic Catalog

Blue Mountain Community College



Building success, strengthening futures.

2012-2013

Academic Catalog

Blue Mountain Community College
Website: www.bluecc.edu

CENTERS IN DISTRICT

BMCC BAKER COUNTY

3275 Baker Street
Baker City, OR 97814
Phone: 541-523-9127
Fax: 541-523-9128
Email: bmccbaker@bluecc.edu

BMCC HERMISTON

975 S.E. Columbia Drive
Hermiston, OR 97838
Phone: 541-567-1800
Fax: 541-567-1020
Email: bmcchermiston@bluecc.edu

BMCC MILTON-FREEWATER

311 N. Columbia
Milton-Freewater, OR 97862
Phone: 541-938-7176
Fax: 541-938-3763
Email: bmccmiltonfreewater@bluecc.edu

BMCC NORTH MORROW COUNTY

P.O. Box 939 / 300 N.E. Front Street
Boardman, OR 97818
Phone: 541-481-2099
Fax: 541-481-3990
Email: bmccnorthmorrow@bluecc.edu

BMCC SOUTH MORROW COUNTY

P.O. Box 21
Ione, OR 97843
Phone: 541-422-7040
Fax: 541-422-7015
Email: bmccsouthmorrow@bluecc.edu

BMCC PENDLETON

P.O. Box 100 / 2411 N.W. Carden Avenue
Pendleton, OR 97801
Phone: 541-276-1260
Fax: 541-278-5871
Email: getinfo@bluecc.edu

CONTRACTED OUT OF DISTRICT CENTER (COD)

BMCC GRANT COUNTY

835-B S. Canyon Blvd.
John Day, OR 97845P
Phone: 541-575-1550
Fax: 541-575-2920
Email: getinfo@bluecc.edu

IMPORTANT CONTACTS

Section 504 Coordinator - P.O. Box 100 - Pendleton, OR 97801 - 541-278-5931
Title II - Senior Director of College Preparatory Programs - P.O. Box 100 - Pendleton, OR 97801 - 541-278-5804
Title IX - Associate Vice President, Enrollment Management - P.O. Box 100 - Pendleton, OR 97801 - 541-278-5774

Blue Mountain Community College is accredited by the Northwest Commission on Colleges and Universities.

**For the most recent updates to this catalog, please view online at www.bluecc.edu.
If you would like a printed copy of this catalog, please call 541-278-5759 or email getinfo@bluecc.edu**

ABOUT THIS CATALOG - The information contained in the current BMCC Academic Catalog and quarterly Schedule of Classes reflects an accurate picture of BMCC at the time of publication. However, conditions can and do change. Therefore, the college reserves the right to make any necessary changes in the matters discussed herein, including procedures, policies, calendar, curriculum, course content, emphasis, and cost. Students enrolling in BMCC classes are subject to rules, limits and conditions set forth in the current Academic Catalog; Schedule of Classes; Statement of Student Rights and Responsibilities, and other official publications of the college.

TABLE OF CONTENTS

INTRODUCTION.....	3	College Costs	24
PRESIDENT'S WELCOME.....	3	Paying Tuition.....	25
VISION STATEMENT.....	3	Tuition Refund Policy.....	25
MISSION STATEMENT	3	Financial Assistance.....	26
STRATEGIC PLAN AND GOALS	3	Federal and State Aid.....	26
GETTING STARTED	4	Other Financial Assistance	27
DEGREES AND PROGRAMS OFFERED	5	Military Educational Benefits	27
ACCREDITATION STATEMENTS.....	5	Oregon Veterans Tuition Assistance.....	28
WELCOME TO BMCC	6	BMCC Military Tuition Waivers.....	28
OUR HISTORY	6	SERVICES AND PROGRAMS FOR STUDENTS.....	30
LIVING IN EASTERN OREGON.....	6	ACADEMIC SERVICES	30
OUR LOCATIONS	7	Testing Services	30
BMCC Pendleton.....	7	Academic Advising.....	30
BMCC Baker County.....	8	HD109 Academic Planning.....	30
BMCC Hermiston	8	Bookstore	30
BMCC South Morrow County.....	8	Copy Center.....	31
BMCC North Morrow County.....	9	Student Union Cafeteria	31
BMCC Milton-Freewater.....	9	Library	31
BMCC Grant County.....	9	Services for Students with Disabilities.....	31
DISTANCE EDUCATION	10	Tutoring Program.....	31
STUDENT INFORMATION	11	TRiO Student Support Services.....	32
STUDENTS' RIGHTS AND RESPONSIBILITIES.....	11	CO-CURRICULAR ACTIVITIES.....	32
Student Right-to-Know Information.....	11	COLLEGE PREPARATORY PROGRAMS.....	33
Statement of Non-Discrimination and Grievance	12	Adult Basic Education (ABE)	33
Drug and Alcohol Statement	12	General Educational Development (GED)	33
Family Educational Rights and Privacy Act.....	12	English as a Second Language (ESL)	33
Solomon Amendment Disclosure.....	12	EL Civics	33
Student Records and Transcripts	12	College Preparation Courses.....	33
Use of Social Security Number	12	JOBS Program.....	34
GENERAL INFORMATION.....	13	OTHER PROGRAMS	34
ADMISSION POLICIES.....	13	Community Education	34
OREGON RESIDENCY REQUIREMENTS.....	13	Continuing Education.....	34
ADMISSIONS PROCEDURES.....	14	ACADEMIC PARTNERSHIPS	34
Degree and Certificate Program Admissions	14	Business Partnerships	34
International Admissions	14	High School Partnerships.....	35
Non-Degree Admissions.....	14	Inter-College Partnerships	35
Placement Assessment	14	Articulated Degree Programs	35
Immunizations	15	DEGREE INDEX.....	39
Adult Basic Education (ABE) and General Educational Development (GED) Admissions	15	CAREER PATHWAYS	38
REGISTRATION INFORMATION.....	15	DEGREES AND CERTIFICATES	40
Degree-Seeking Students.....	15	Statement of Student Outcomes.....	40
Non-Degree Seeking Students.....	15	Computer Literacy Requirement.....	40
Priority Registration.....	16	Transfer Options	40
Course Numbers.....	16	Degree and Certificate Options	41
Credits	16	DEGREE CHECKLISTS	42
Attendance.....	16	Associate of Arts Oregon Transfer Degree	42
Auditing Classes	16	Associate of Science Degree	43
Dropping/Withdrawing from Classes	16	Oregon Transfer Module	44
Waitlisted Courses.....	16	Associate of General Studies Degree	45
Withdrawal from College.....	16	Associate of Applied Science Degrees	46
Withdrawal for Military Duty.....	17	CERTIFICATE AND DEGREE DETAIL LISTING.....	47
ACADEMIC INFORMATION	17	Food and Natural Resources Pathway	47
Grading System.....	17	Business Management Pathway.....	50
Enrollment Status.....	18	Health Services Pathway.....	60
Audit Policy	18	Human Resources Pathway	64
Grade Changes.....	19	Industrial and Engineering Systems Pathway.....	70
Grade Appeal Process.....	19	Apprenticeship.....	72
Grade Point Average (GPA) Renewal Policy	19	TRANSFER COURSE LIST.....	77
Final Examinations.....	19	MATH & WRITING PROGRESSION CHARTS	81
Academic Achievement Recognition	19	COURSE DESCRIPTIONS	82
Institutional Academic Progress.....	19	BMCC BOARDS AND PERSONNEL.....	131
Nontraditional College Credit	19	GLOSSARY	139
Transfer Credits.....	21	BMCC CAMPUS MAPS	145
Appeal of Graduation Requirements	21	BMCC PHONE DIRECTORY	153
Graduation.....	22	ACADEMIC CALENDAR.....	154

INTRODUCTION



President's Welcome...

I am pleased that you have picked up our catalog, because we want to help you with your goals. BMCC has something for everyone, whether you want to improve your English language skills, earn a GED, or begin taking courses for college credit. If you have an interest in a particular area of work, ask to talk to an advisor to see what we can do for you.

Paying for college should not keep you from getting started. If you need to take out a government-backed student loan, our financial aid department will help you with every step. Students may also apply for scholarships through our Foundation.

If it has been awhile since you were a student and your academic skills are not as sharp as you would like them to be, don't worry. We have a Student Learning Center in Pendleton, and there are tutors at our branches who will help you. We have classes that can help you brush up your skills in math, writing, and other areas. If you don't know exactly what classes to take or which direction to turn, we have advisors at every one of our locations who are waiting to talk to you.

If you are an employer who needs us to provide some specific workforce training for your employees, we can do that. We also have a Small Business Development Center that helps to make small businesses successful.

Our goal is to help our students succeed. Let us know how we can help you!

John H. Turner , President
Phone: 541-278-5951
Email: jturner@bluecc.edu

Vision Statement

Blue Mountain Community College will be the leading educational and training institution in eastern Oregon.

Mission Statement

Blue Mountain Community College will realize its vision by providing high-quality programs for college preparation, college transfer, professional/technical training, workforce development, and self-improvement that will strengthen the economy and provide opportunities for personal and professional growth.

The college provides dynamic and innovative programs and delivery methods in response to the changing needs of our customers; the students, businesses, industries and communities of eastern Oregon.

Strategic Plans and Goals

The Blue Mountain Community College Board of Education reviews the 2004-2014 strategic plan on an annual basis and will accomplish the goals listed below.

BMCC will focus on student success in a premiere learning environment and:

- Enhance student support
- Develop a more relevant and comprehensive curriculum
- Facilitate access to college programs and activities
- Develop employees to their highest potential
- Strengthen the institution through assessment and planning
- Increase resources for financial growth and stability
- Grow community partnerships
- Integrate and expand marketing and recruiting

Blue Mountain Community College

GETTING STARTED

Get Started at...

Blue Mountain Community College

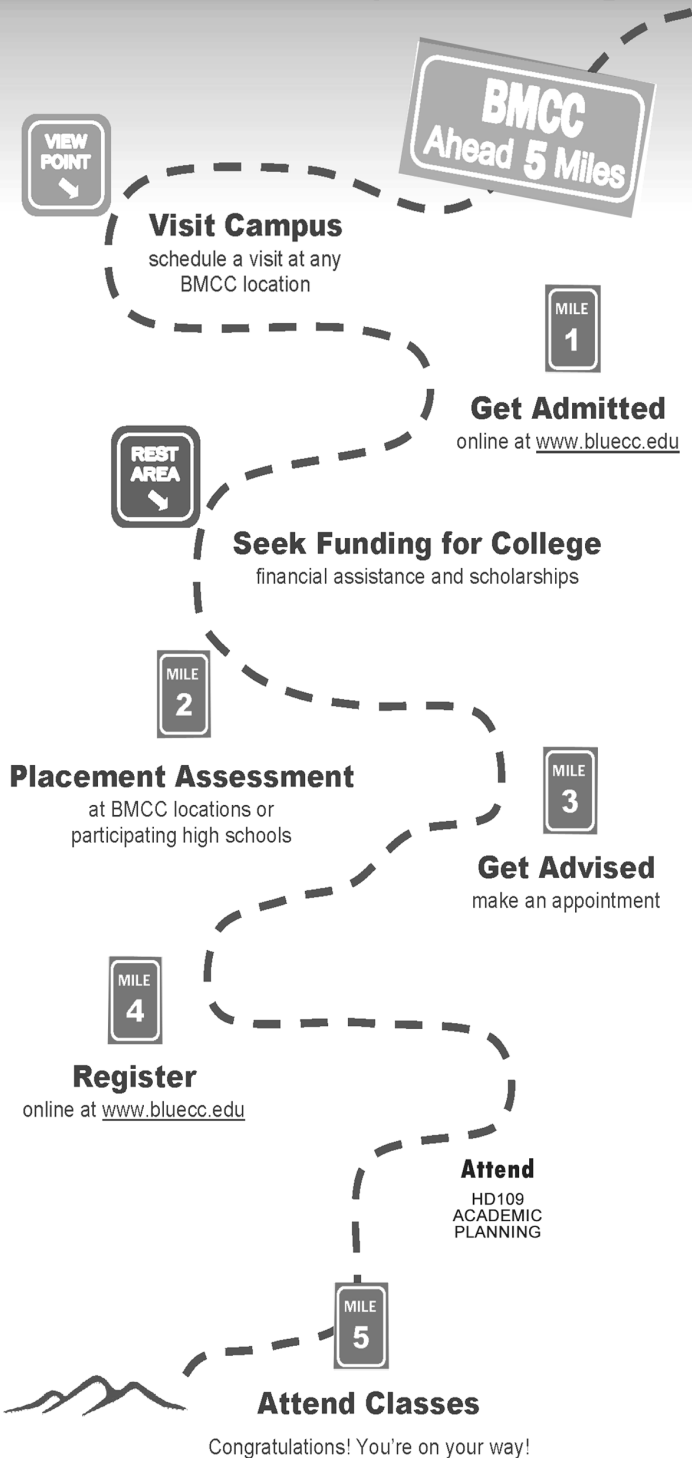

Apply for admission – online or in person. Online you will click on *STUDENT WOLFWEB* and follow the instructions or you can pick up a paper admissions form at any BMCC Service Center.

Transfer Students. If you have attended college prior to coming to BMCC and would like those credits to be considered toward your BMCC degree, you will need to request an official transcript be sent to BMCC. You also need to fill out a “Transcript Evaluation Request” form. You can find it on the BMCC Website under student forms. Turn in the completed form at the Service Center.

Apply for financial assistance. The easiest way to get the most complete information concerning financial assistance is to go to the BMCC Website. For more information, call 541-278-5759, e-mail finaid@blueecc.edu, or stop by the Service Center.

Take the Placement Assessment. As a new student at BMCC, you may need to complete placement assessments in math, writing, reading, and computer literacy at all BMCC locations. If you have already done this, or have completed coursework at another college, contact the BMCC Advising and Testing Center at 541-278-5931 for further information. The placement assessment fee is \$10.

Meet with an advisor. As a new student you must work with an advisor before registering. Please contact the Advising and Testing Center at 541-278-5931 to make an appointment.

Register for classes. Once you have met with your advisor, go to www.blueecc.edu, click on *STUDENT WOLFWEB* and login to your personal account. Once there, click on *Register for Classes*.

Register for HD109 Academic Planning. All new students are required to attend this course, where you will get to know the tools available at BMCC and improve your chances for success in college.

Pay for classes. You can pay your bill at any BMCC location or online by going to your personal account on the *STUDENT WOLFWEB* and paying with a credit or debit card. See our Website for payment methods and deadlines.

Purchase textbooks. You can purchase your textbooks at the BMCC Bookstore in Pendleton, online at our Website, or at the BMCC location where the course is offered. If you have any questions, please call the bookstore at 541-278-5733.

Blue Mountain Community College Degrees and Programs Offered

Blue Mountain Community College provides educational opportunities in the following programs:

Lower-Division Collegiate Transfer Programs

Associate of Arts Oregon Transfer (A.A.O.T.) Degree

Associate of Science (A.S.) Degree

Associate of General Studies (A.G.S.) Degree

Career and Technical Programs A.A.S./Certificates and Career Pathways Certificates of Completion (CPCC)

These programs provide students with training to qualify them for work in specific fields. One-year certificates and/or two-year associate of applied science degrees are offered in the following areas:

Accounting Technology

Administrative Office Professional: General, Legal,
Medical

Agriculture Business, Production, Crops, Livestock

Business Administration and Management

Civil Engineering Technology

Criminal Justice

Construction Trades, General Apprenticeship

Dental Assisting Technician

Diesel Technology

Drafting Technology

Early Childhood Education

Electrician Apprenticeship Technologies

Emergency Medical Technologies

English Language Development

Green Technician

Hospitality, Tourism, Gaming, and Management

Industrial Mechanics and Maintenance Technology

Apprenticeship

Nursing

Office Assistant/Support: General, Medical, Legal

Paraeducator

Retail Management

Welding

College Preparatory Programs

Adult Basic Education (ABE)

General Educational Development (GED)

English as a Second Language (ESL)

JOBS Program

Business and Industry Training

These programs, including the Small Business Development Center (SBDC), provide business and industry training customized to meet the needs of students and the specific needs of local businesses, organizations, and government agencies.

Inter-College Partnerships

CUESTE: Teacher Education Program with Eastern Oregon University

Eastern Oregon Collaborative Colleges Council with Treasure Valley Community College and Eastern Oregon University

Medical Laboratory Technician (MLT) Program with Wenatchee Valley Community College

Diagnostic Imaging Technology (DIT) with Linn-Benton Community College

Oregon State University Dual Admission

Pharmacy Technician Program with Central Oregon Community College

Occupational Therapy Program with Linn-Benton Community College

Accreditation Statements

BMCC is a public, two-year, coeducational college accredited by the Northwest Commission on Colleges and Universities, 8060 165th Avenue N.E., Suite 100, Redmond, WA 98052, phone: 425-558-4224.

Programs at the college are approved by the Oregon Department of Education, to offer education and training under the various public laws pertaining to financial assistance to veterans.

The nursing program is accredited by the Oregon State Board of Nursing.

The dental assisting technician program is accredited by the American Dental Association Commission on Dental Accreditation.

The emergency medical technician classes are accredited by the Oregon Department of Education.

Welcome to BMCC

Blue Mountain Community College (BMCC) is a comprehensive community college committed to providing a premier learning environment and support for student success. Program areas include career and technical certificates and degrees, college transfer degrees, college preparatory and adult basic skills training, workforce development programs, continuing education, and community education. BMCC offers students high-quality instruction, affordable tuition, small class sizes, and student support services such as tutoring, computer labs, academic advising, and disability accommodations.

Though its taxing district comprises Baker, Morrow, and Umatilla counties, BMCC serves all of northeastern Oregon—including Grant, Union, and Wallowa counties—through its locations in Pendleton, Hermiston, Baker City, Milton-Freewater, Boardman, and John Day. In addition, BMCC provides selected on-site services to the Confederated Tribes of the Umatilla Indian Reservation. BMCC uses distance education learning modalities to serve residents throughout region as well as a small number of students from around the world.

On average, BMCC employs 350 full-time and part-time persons, with an annual payroll of over \$15,000,000.

In 2010-11, BMCC enrolled 10,660 students, of which 3,336 were seeking a certificate or associate's degree. A total of 1,971 students received \$12.2 million in financial assistance in the form of federal and state assistance, scholarships, grants, tuition waivers, other assistance, and work/study jobs. Both dual credit courses and expanded options classes are offered to area high school students; 851 dual-credit and 88 expanded-options students earned college credits for advanced classes taken in their high schools, at BMCC locations, or via distance learning. The growth and sophistication of technology have expanded the number of courses offered via distance learning to more than 200; 2,629 students took at least one distance learning course in 2010-11.

Typical of community college student populations, the average age of all BMCC students is 35, whereas degree-seeking students average 30 years of age. Student demographic data rely on self-reporting: 2,414 students identified themselves as belonging to minority populations, and 500 identified themselves as veterans. Class size is generally fewer than 30 students.

Our History

Blue Mountain Community College was established on July 1, 1962, after winning an overwhelming five-to-one vote of confidence by the residents of Umatilla and Morrow counties.

The college opened its doors in September of that same year. Vocational-technical courses were initially taught at Pendleton's John Murray Junior High School; college transfer programs were added a year later. In 1965, BMCC moved the campus to the north hill overlooking Pendleton. Within ten years, the original construction plans for the college were completed. In September 1992, the college purchased Columbia Hall in Hermiston to

accommodate a growing student population in western Umatilla County. In October 1993, the college created a center in Milton-Freewater by leasing the former US Bank Building. In 1994, the Milton-Freewater Continuing Education Office and Basic Skills Center moved to the same location.

Fall term 1995 marked the beginning of BMCC's distance education program. While the college had offered tele-courses for a number of years, newer media such as videotapes, the Internet, and ED-NET expanded the options of potential students who were bound by constraints of time or location. Today, our distance education program continues to grow with over 100 courses available. Distance education delivery is now primarily Web-based. There are also complete links to faculty instructors and other classmates. And, there are also complete degree programs available to our students via distance education. In fact, all BMCC course offerings now have some technology components incorporated into them so that students are exposed to and comfortable with the expanding technology that has become an everyday part of all of our lives.

In November 1998, the voters in Morrow and Umatilla counties passed a bond measure for facility expansion in district growth areas. The bond financed expansion of the centers in Hermiston and Milton-Freewater and the opening of the BMCC Morrow County center in Boardman. The Pendleton campus expansion included new technical agriculture buildings, a new science and technology building, and the remodeling and upgrading of older facilities.

A ballot measure in March 2000 annexed Baker County into the BMCC district. Classes at BMCC Baker County began in the fall of 2000.

The most recent development has been the construction of the Eastern Oregon Higher Education Center in Hermiston. The project, five years in the planning, has expanded access to postsecondary education for the residents of communities in west Umatilla, north Morrow, and east Gilliam counties. Upon the Oregon State Legislature's approval in June 2009 of \$7.4 million in lottery-backed bonds for the project, and with previously secured funds (including federal appropriations and private donations), BMCC began design and construction of the new building. The building opened for classes in September of 2011.

Blue Mountain Community College looks forward to celebrating its 50th anniversary in October of 2012. Activities will honor the leaders—board of education members, presidents, faculty, staff, alumni, and community—whose vision has helped our college continue to grow to serve the eastern Oregon community.

Living in Eastern Oregon

Many communities in the counties served by the college have unique seasonal festivals and historic architecture that reflect the spirit and history of the region. The world-famous Pendleton Round-Up celebrates the heritage of the West every September with rodeo competitions, community events, and pageants. This cowboy sport is also enjoyed at county fairs and other festivals

Welcome to BMCC

throughout the region. The Hermiston FunFest, Baker City's Miners' Jubilee, and Milton-Freewater's Muddy Frogwater Festival are a few of the many popular events that showcase local products and community pride. Farmers' markets are also a part of eastern Oregon culture. Beginning in the spring and continuing into fall, these weekly gatherings provide access to the freshest of fruits and vegetables, arts and crafts, music, and opportunities for visiting with neighbors and new friends.

Bordered by the Blue Mountains, the Columbia River, and rolling crop land, our district abounds in recreational attractions. The local area offers an abundance of year-round recreational sites, including state and national parks. The Umatilla National Forest, under the jurisdiction of the U.S. Forest Service, provides more than a million acres of wilderness recreation opportunities. Skiing, snowboarding, fishing, hiking, rafting, and hunting are outdoor activities available to BMCC students, local residents, and visitors. There are also many golf courses, open roads for bicycling, and vibrant parks and recreation organizations providing intramural sports and activities that will keep people of all ages busy throughout the year.

Eastern Oregon has four distinct seasons with a very livable climate. Sun-filled summers see temperatures ranging from 73 to over 100 degrees, while winters average 33 degrees. Humidity is low, averaging 45 to 50 percent. Our dry climate produces about 13 inches of rain each year. Snow is close at hand for winter fun.

The closest major cities to the main campus in Pendleton are Boise (223 miles), Portland (210 miles), and Spokane (206 miles). There is a small regional airport in Pendleton that serves travelers commuting to and from Portland. Also available at a reasonable distance is the Walla Walla, Washington airport and the Pasco, Washington airport.

Our Locations

Typical of many community colleges, Blue Mountain Community College has a main campus, five centers, one contract-out-of-district (COD) location, and a distance learning delivery system to better serve students in the region. Students have access to the following services at all BMCC locations:

- Information on obtaining financial assistance (grants, loans, scholarships)
- Academic advising and degree planning
- Placement assessments in math, writing, reading, and computer literacy
- Courses, workshops, and other educational offerings
- Tutoring and/or academic assistance; computer labs
- Textbook purchases
- Disability accommodations

Each site offers services unique to its operation.

BMCC Pendleton

P.O. Box 100
2411 NW Carden Ave
Pendleton, OR 97801
Phone: 541-278-5759
Fax: 541-278-5871
Email: getinfo@bluecc.edu

Blue Mountain Community College's main campus is located on a scenic 140-acre hilltop site that includes a 100-acre farm. The campus overlooks Pendleton, a city of 16,800 residents, located 210 miles east of Portland and nearly equidistant from Seattle, Spokane, and Boise.

Programs and classes include:

- College credit classes/A.A.O.T. degree
- Career-technical programs (certificate and associate of applied science degrees)
- College preparatory classes including adult basic education (ABE), general educational development (GED) preparation and testing, and English as a second language (ESL)
- Customized training for business and industry
- Continuing education classes
- Community education/personal enrichment courses
- Small Business Development Center

The Pendleton campus houses both cultural and recreational venues. The Betty Feves Memorial Gallery, located in Pioneer Hall, exhibits a wide variety of art and functions as an educational tool to encourage creativity and to foster an appreciation of the visual arts. The Bob Clapp Theatre, also in Pioneer Hall, hosts a variety of activities including concerts, lectures, and workshops and is home to the College Community Theatre, which produces three plays a year. The college hosts an Arts & Culture Festival in April, with a focus on diversity. The McCrae Activity Center houses handball and racquetball courts, a weight room, a total fitness room, a gymnasium, and a 25-meter heated swimming pool.

Varieties of co-curricular activities augment the education offered on campus and are an important component of the Blue Mountain Community College experience. For the serious athlete, BMCC has a well-rounded athletic program for both men and women. The college fields intercollegiate teams in basketball, volleyball, softball, baseball, and rodeo. Students have an opportunity to become involved in the Associated Student Government (ASG), work as a student ambassador, or join a variety of student clubs, all of which provide educational, recreational, social, and leadership opportunities for interested students.

Student support services include a TRiO program (for qualified students), a Student Learning Center, a full-service library, computer labs, tutoring, career research tools and resources, and faculty advisors.

Tours of the BMCC Pendleton campus may be arranged by contacting the outreach coordinator at 541-278-5936 or by emailing: getinfo@bluecc.edu.

Welcome to BMCC

BMCC Baker County

3275 Baker Street
Baker City, OR 97814
Phone: 541-523-9127
Fax: 541-523-9128
Email: bmccbaker@bluecc.edu

With two sites in Baker City, on Baker Street and in the National Guard Armory, BMCC Baker County has a variety of offerings.

- College credit classes/A.A.O.T. transfer
- Job skills workshops
- College preparatory classes including ABE, GED preparation and testing, and ESL
- Customized training for business and industry
- Emergency medical training, certified nursing assistant (CNA), pharmacy technician, phlebotomy, first aid, and certain occupational certifications
- Personal enrichment courses

BMCC Baker County offers the entire A.A.O.T. degree with traditional class offerings. Students can also combine distance education classes with traditional day/evening classes for more flexibility. Additionally, the Small Business Development Center has a representative at BMCC Baker County.

As at other centers, students attending courses through the Baker County center are also welcome to get involved in student clubs such as Phi Theta Kappa National Honor Society and the Veterans Club. These clubs offer students the opportunity to participate in leadership and community service.

For additional information or to schedule a tour, please contact the BMCC Baker County office.

BMCC Hermiston

975 S.E. Columbia Drive
Hermiston, OR 97838
Phone: 541-567-1800
Fax: 541-567-1020
Email: bmchermiston@bluecc.edu

BMCC Hermiston serves western Umatilla County and North Morrow County. Offerings include:

- College credit classes/A.A.O.T. degree
- Job skills workshops
- College preparatory classes including ABE, GED preparation and testing, and ESL in English and Spanish
- Customized training for business and industry
- Emergency medical training, first aid, and occupational certifications
- Personal enrichment courses
- Citizenship classes
- Welding classes
- Business Technology (Business Lab)

With the fall 2011 opening of the Eastern Oregon Higher Education Center, BMCC Hermiston offers students increased access to postsecondary education and related student services, in partnership with Eastern Oregon University (EOU). BMCC offerings include courses leading to the A.A.O.T. degree, as well as other degrees and certificates, and expanded course offerings throughout the day and evening. EOU offers new on-site courses in business, education, and liberal studies, as well as the continued availability of online programs.

Students at BMCC Hermiston can participate in student organizations and clubs. Phi Theta Kappa National Honor Society, Associated Student Government, and BMCC student ambassadors all have representatives from their groups attending class at BMCC Hermiston. Student life activities are no longer limited to the Pendleton campus!

The Oregon JOBS program (a welfare-reform contract with the Oregon Community Human Services Department) and the Small Business Development Center have services available at BMCC Hermiston. For additional information or to schedule a tour, please contact the BMCC Hermiston office. An EOU representative is also on-site full time.

BMCC South Morrow County

P.O. Box 21
Lone, OR 97843
Phone: 541-422-7040
Fax: 541-422-7015
Email: bmccsouthmorrow@bluecc.edu

BMCC South Morrow County provides support services for students in the Heppner, Lexington, and Lone areas and offers the following services:

- BMCC distance education classes
- Job skills workshops
- Personal enrichment classes

For additional information or assistance, please contact the BMCC South Morrow County office.

Welcome to BMCC

BMCC North Morrow County

300 N.E. Front Street
Boardman, OR 97818
Phone: 541-481-2099
Fax: 541-481-3990
Email: bmccnorthmorrow@bluecc.edu.

BMCC North Morrow County in Boardman serves the western-most region of the college district. The center offers a variety of:

- Job skills workshops
- College preparatory classes, including ABE, GED preparation, and ESL
- Customized training for business and industry

Students have the opportunity to take classes at the local site, or they may choose to take advantage of the distance education classes, which allow students to complete their classes using the Internet, videotapes, guided instruction, or ITV. Using a combination of on-site and distance education, students may complete their A.A.O.T. degree at BMCC North Morrow County. Classes are offered at BMCC North Morrow County during both day and evening hours.

BMCC Milton-Freewater

311 N. Columbia
Milton-Freewater, OR 97862
Phone: 541-938-7176
Fax: 541-938-3763
Email: bmccmiltonfreewater@bluecc.edu

This growing center, located five miles south of the Oregon-Washington state line on State Highway 11, offers classes on-site in a variety of delivery formats including traditional, condensed, and weekend classes, as well as a wide offering of courses delivered via ITV. By combining on-site and distance courses, students may complete a variety of degrees and certificates. In addition, Milton-Freewater offers:

- College credit classes/A.A.O.T. degree
- Business technology labs
- Job skills workshops
- College preparatory classes including ABE, GED preparation and testing, and ESL
- Customized training for business and industry
- Personal enrichment courses
- Welding classes
- First aid/CPR courses
- Citizenship classes

Students attending courses through the Milton-Freewater center are also getting involved in student clubs like Phi Theta Kappa National Honor Society and the Veterans Club. These clubs offer students the opportunity to get involved at their local center. The staff at BMCC/Milton Freewater also hosts numerous ASG student appreciation events such as BBQs, hot dog feeds, Nacho Night, the Tiki Hut, and Love our Students Night.

The Oregon JOBS program is available at Milton-Freewater. For additional information or to schedule a tour, please contact the BMCC Milton-Freewater office.

BMCC Grant County

835-B S. Canyon Blvd.
John Day, OR 97845
Phone: 541-575-1550
Fax: 541-575-2920
Email: getinfo@bluecc.edu

Established in 1987 and located in John Day, BMCC Grant County provides learning opportunities to the residents of Grant County, including:

- College credit classes
- Community enrichment classes
- Job training courses/workshops
- Certified nursing assistance certificate program
- College preparatory classes including ABE, GED preparation, and ESL

BMCC Grant County focuses on building relationships with community organizations, local businesses, and area schools to serve the citizens of Grant County. This site provides support services for students to access BMCC distance education courses. For additional information or to schedule a tour, please contact the BMCC Grant County office.



Distance Education

What is Distance Education?

Distance education is any kind of learning in which students and the instructor are separated by time and/or place. It can be delivered using various methods of technologies, including:

E-Course : Course offerings are provided over the Internet.-asynchronously. Tests are conducted online, at a BMCC location, or an approved proctored site.

E-Live: Courses using a web-conferencing tool, delivered synchronously (real time). This delivery method offers students the opportunity to interact with faculty and other students even though separated by space. Students may take classes from any computer that has Internet access. E- Live classes can be done in real time, with the instructor teaching at a designated site, while the student participates from a computer located anywhere there is internet service. Classes are recorded and can be viewed at a later time.

Interactive Video Conferencing (ITV): Classes originate from another site but are in real-time and place. Classes are offered through interactive television or Web-based software.

Who Benefits From Distance Education?

The time-bound student, whose job or education schedule conflicts with the times when classes are offered on campus.

The distance-bound student, who lives far from where classes are offered.

The home-bound student, who cannot leave home for personal reasons.

Those who have work schedules which prevent them from finding blocks of time to participate in classes.

Those who seek to advance themselves in their current career or to prepare for a new career.

Who Should Take Distance Education Classes?

Self-motivated learners
Time- or place-bound learners
Technically astute learners

Registering for Distance Education Classes:

Student services and financial assistance information for distance education students—such as admissions, enrollment, registration, advising, book purchases, and payment—are the same as for any other classes offered at BMCC, noted elsewhere in this catalog. Please see the “Getting Started” section on **page 4** for more information. For registration information and a list of courses, go to www.bluecc.edu.

Financial Assistance for Distance Education:

Online students may be eligible to receive financial assistance. Complete the Free Application for Federal Student Aid (FAFSA) form, available online at www.fafsa.ed.gov. BMCC’s federal school code is 003186. Check page 22 of this catalog or our Website for more financial assistance information.

Paying for Distance Education Classes:

Blue Mountain Community College’s distance education classes are assessed at the current tuition and fees listed in the Schedule of Classes published each term and online at www.bluecc.edu. There is an additional distance education class fee for each class.

Purchasing Distance Education Textbooks:

Students can order books online with a credit card at www.bookstore.bluecc.edu, or students can call the bookstore at 541-278-5733 or send a fax to 541-278-5842. Students taking an online course provided by another Oregon community college (host/provider) may order books by contacting the BMCC bookstore.

Library Services:

Many library services and electronic databases are available online to all students, whether on or off campus. Go to www.bluecc.edu/library for information on library services.

Technical Help and Support:

The Office of Distance Education is located on the Pendleton campus in Pioneer Hall, Room 154. The email address is Distance_Ed@bluecc.edu.

Find tutorials, frequently asked questions, self-assessment tests, and hardware and software requirements for taking online classes on the Distance Education page of our website. Students can view current term class information on the Distance Education webpage.

Student Information

Students' Rights and Responsibilities

At Blue Mountain Community College, we support your right to actively question and seek constructive change in the college environment. We encourage you to express your views, opinions, and concerns in and around BMCC. Our goal is to promote diverse and critical thinking—it's an important part of your college education. However, any kind of conduct that restrains either the freedom of expression or the freedom of movement of others who may not agree, or that is disruptive to college operations in any way, is not acceptable. As a learning community, all of us have an equal right to our own views, and BMCC is committed to keeping the college a safe place for all students, staff, and community members.

The *Student Rights, Responsibilities, and Code of Conduct* document outlines the expectations we have of you as you participate on campus and in college activities. If you'd like to review or receive a complete copy of the *Student Rights, Responsibilities, and Code of Conduct* document, contact the registrar, the associate vice-president of enrollment management, or the Associated Student Government. You may also pick up a copy at the reserve desk in the college library. This statement is also online at www.bluecc.edu.

Student Right-to-Know Information

In compliance with the Student Right-to-Know and Campus Security Act of 1990 (Public Law 101-542), Blue Mountain Community College discloses completion/graduation rates and transfer rates to all current and prospective students. Rates are based on fall-term enrollment of full-time (12 term credits), first-time, and degree- or certificate-seeking undergraduates. Students are counted as graduates or as transfer-outs if they graduated or transferred within 150 percent of the normal time for completion or graduation. Rates do not include part-time credit students, students who have attended college elsewhere before attending BMCC, students who began their studies in a term other than fall, or students not seeking degrees. For further information, contact the Office of Enrollment Management at 541-278-5774.

Statement of Non-Discrimination and Grievance

It is the policy of the Blue Mountain Community College Board of Education that there will be no discrimination or harassment on the grounds of race, color, sex, marital status, religion, national origin, age, or disability in any educational programs, activities, or employment. If you have questions about equal opportunity and nondiscrimination, contact the executive assistant to the president at BMCC, P.O. Box 100, 2411 N.W. Carden, Room P-103 in Pioneer Hall, telephone 541-278-5951 or TDD 541-278-2174.

The college has adopted a grievance procedure providing for prompt and equitable resolution of student and employee complaints alleging any discrimination based on sex or disability.

To view this procedure, go to www.bluecc.edu, About BMCC, Human Resource Information.

Drug and Alcohol Statement

Blue Mountain Community College is legally required and morally committed to the prevention of illicit drug use and abuse of alcohol by both students and employees.

The college reinforces this message through various publications that explain our policy and procedures on this issue, including the *Students Rights, Responsibilities, and Code of Conduct* document, the Student Handbook, and all employee handbooks. These items are available to students through the Office of Enrollment Management and to employees via the StaffWeb or the Office of Human Resources.

Family Educational Rights and Privacy Act (FERPA)

The college abides by and honors all state and federal laws pertaining to the privacy and confidentiality of your directory information and academic records. If you choose to do so, you have the right to restrict access to specific information.

FERPA allows colleges to disclose your directory information without consent. If you do not want this information released, you must update your response to "May BMCC release your directory information" question within the Student Information area of the Student Wolfweb, or complete, sign, and return a Directory Exemption Request form along with a picture ID to any BMCC location.

Placing a directory exemption on your file will:

- Prevent staff from being able to assist you over the phone.
- Exclude your information from publication in the newspaper should you qualify for Honor Roll, the Dean's List, or the President's List.

The Family Educational Rights and Privacy Act of 1974 (FERPA) grants you, the student, certain rights, privileges, and protections relative to individually identifiable student educational records that are maintained by BMCC. In general students are afforded the following rights:

- The right to inspect and review their own individual educational records.
- The right to have some control over the disclosure of information from their own educational records (by authorizing or denying access in writing).
- The right to file complaints of alleged failures to comply with the requirements of FERPA (with the U.S. Department of Education).

A student's educational records (with the exception of directory information) will be released to third parties only with the written consent of the student.

Student Information

Directory information at Blue Mountain Community College includes a student's:

- Full name
- Address
- Telephone number
- Field of study
- Class level
- Dates of attendance
- Degrees, honors, and awards
- Athletic participation (including the height and weight of team members)
- Most recent previous educational institution attended.

FERPA Annual Notice to Reflect Possible Federal and State Data Collection and Use

As of January 3, 2012, the U.S. Department of Education's FERPA regulations expand the circumstances under which your education records and personally identifiable information (PII) contained in such records — including your Social Security Number, grades, or other private information — may be accessed without your consent. First, the U.S. Comptroller General, the U.S. Attorney General, the U.S. Secretary of Education, or state and local education authorities ("Federal and State Authorities") may allow access to your records and PII without your consent to any third party designated by a Federal or State Authority to evaluate a federal- or state-supported education program. The evaluation may relate to any program that is "principally engaged in the provision of education," such as early childhood education and job training, as well as any program that is administered by an education agency or institution. Second, Federal and State Authorities may allow access to your education records and PII without your consent to researchers performing certain types of studies, in certain cases even when we object to or do not request such research. Federal and State Authorities must obtain certain use-restriction and data security promises from the entities that they authorize to receive your PII, but the Authorities need not maintain direct control over such entities. In addition, in connection with Statewide Longitudinal Data Systems, State Authorities may collect, compile, permanently retain, and share without your consent PII from your education records, and they may track your participation in education and other programs by linking such PII to other personal information about you that they obtain from other Federal or State data sources, including workforce development, unemployment insurance, child welfare, juvenile justice, military service, and migrant student records systems.

For more information or to exercise your rights contact the associate vice president of enrollment management at 541-278-5774.

Solomon Amendment Disclosure

The Solomon Amendment requires by law that the college release to U.S. military recruiters the following student information: name, address, telephone numbers, date of birth, educational level, academic major, and degrees awarded. Note:

students who have selected the Directory Exemption option will cause Blue Mountain to withhold their information from military recruiters.

Student Records and Transcripts

Student records are maintained in the registrar's office per the college's official record retention schedule. These records may include transfer credit evaluations, correspondence, curriculum deviations, and degree evaluations.

Transcripts of Blue Mountain Community College are kept permanently. You may request your official transcript by completing a Transcript Request form. The form can be found on the Students page of our website on the link "Forms for Students". If you owe a financial obligation to the college, your official transcript will be withheld until the debt has been paid in full.

Please be sure to update your address online through the Student Wolfweb.

Use of Social Security Number

You are requested to voluntarily provide your Social Security Number to assist BMCC and the Oregon Community College Unified Reporting System (OCCURS) (and organizations conducting studies for or on behalf of BMCC) for the purposes of record-keeping and research.

When conducting studies, BMCC and OCCURS will disclose your Social Security Number only in a manner that does not permit personal identification of you by individuals other than representatives of BMCC (or the organization conducting the study for BMCC). By providing your Social Security Number, you are consenting to the use identified above. Request for release is made under the authority of ORS 341-290(17) and in accordance with OAR 589-004-0400. Provision of your Social Security Number and consent to its use is not required and if you choose not to do so you will not be denied any right, benefit, or privilege provided by law. You may revoke your consent for the use of your Social Security number at any time by contacting: Office of the Registrar, Blue Mountain Community College, Pendleton, OR 97801; 541-278-5757.

All access and use at Blue Mountain Community College of the Social Security number is prohibited except for meeting federal or state requirements, compliance and reporting.

General Information

Admission Policies

Blue Mountain Community College has an open-door admission policy. In general, you may enroll provided you:

- Are eighteen years of age or older, **or**
- Are legally emancipated (with documentation), **or**
- Have graduated from an accredited high school, **or**
- Have completed a general educational development (GED) certificate or an adult high school diploma, **and**
- Have the ability to benefit from instruction.

If you are under eighteen years of age and no longer attending high school, have not graduated from an accredited high school or completed a GED, and wish to attend BMCC, you may enroll by providing the following:

- A letter from a high school administrator stating that you have been released from compulsory school attendance under the provisions outlined in ORS 339.030, **and**
- An assessment by a BMCC advisor regarding your ability to benefit from the instruction desired, **and**
- Your parent's signature on any enrollment or registration document that obligates you, the student, financially, **and**
- An acknowledgement that you will be in a classroom situation with other adults and without the same protections and rules of the K-12 system.

If you are under the age of eighteen and still attending high school and wish to take a class or two for personal enrichment or for credit at your high school, you may do so with parental sign-off on the financial obligations incurred. If you wish to take classes for high school credit, please check with your high school administration to ensure that the credits taken will transfer in the way you intend.

If you were home-schooled, you are welcome to enroll in classes and attend BMCC under the same conditions as other students. If you or your family members have questions about admission, please contact the Service Center in Pendleton at 541-278-5759.

Oregon Residency Requirements

Your residency status determines your tuition rate for your classes. The college has three tuition schedules: in-state, out-of-state, and international. For purposes of determining tuition rates and receiving state reimbursement, BMCC is required by law to establish a residency policy.

You may petition for residency if at least one of the in-state criteria is met **and** you provide at least two of the documents listed on this page. Petitions must be made in writing.

Your requests should be submitted, along with at least two of the documents listed below to the Service Center located on the Pendleton campus for approval.

In-State Criteria (student must meet at least one):

- The student has maintained a permanent address in Oregon for at least 90 continuous days prior to the first day of the term.
- The student is a resident of Washington, Idaho, Nevada, Montana, or California.
- The student or a member of the immediate family holds title to or is otherwise purchasing property that is claimed as a permanent Oregon residence.
- The student or parents of a dependent student filed an income tax statement with the Oregon Department of Revenue for the most recent reporting year.
- The student is a veteran who established residency in Oregon within one year of separation or discharge from the service.
- The student is a dependent of parents or legal guardians who have established permanent residency within Oregon.

Documents (student must provide at least one):

- An Oregon hunting or fishing license that was issued at least ninety days before the beginning of the term.
- A copy of deed of title, mortgage agreement, or recent county property tax statement indicating ownership or purchase by the student or the immediate family. If ownership is by anyone other than the student, a document verifying the relationship between the student and an owner must be presented.
- A current Oregon voter precinct card.
- A copy of a signed Oregon income tax statement filed during the latest reporting year or payroll records from an Oregon firm indicating ninety continuous days of residency in Oregon.
- A copy of an official Oregon high school transcript or GED scores earned in the state of Oregon.
- A copy of a valid Oregon driver's license (front and back of license).

Out-of-State Criteria

With the exceptions listed above, you must pay out-of-state tuition if you have listed your permanent address as being outside of Oregon or if you listed your parents' address as outside Oregon and you are claimed as a dependent by your parents on their income tax report. If you are an Alaska resident and you wish to receive the Alaska Permanent Fund Dividend while attending BMCC, you must maintain your out-of-state residency status.

International Criteria

If you are a citizen of another country and are attending BMCC on a student visa, you must apply for international student admission and will pay the international tuition rate.

General Information

Admission Procedures

Degree and Certificate Program Admissions

If you are seeking a degree or certificate, you are required to:

- Complete and submit a BMCC Application for Admission to any BMCC location.
- Complete the COMPASS placement assessments. Transfer students who have not successfully completed a college- or university-level math and/or writing course will be asked to take the COMPASS placement assessments. If you have taken a math or writing course from another institution you will need to submit a Pre-requisite Override Request form and attach at least an unofficial copy of your transcript to the Service Center located on the Pendleton campus. If you have taken a math or writing placement assessment at another college within the last two years, you may submit a copy of your placement results to BMCC's Testing Center on the Pendleton campus for placement in your BMCC courses.

Transfer Students:

A *Transcript Evaluation Request* should be submitted upon entry to BMCC. Credits earned and completed with a grade of D or higher will be evaluated. The Office of the Registrar will send an email to you notifying you of credits accepted toward your stated degree intent at BMCC.

Those courses that meet the course requirements for your degree will be included in the cumulative grade point average (GPA) computation for graduation, including core courses and all appropriate electives. Courses not applied towards your stated degree intent at BMCC will not be counted in the cumulative GPA. Courses accepted towards degree requirements will not be listed on your BMCC transcript; however, a note will appear at the top of your transcript regarding a cumulative number of transfer credits accepted for that degree.

Limited-Entry Programs:

BMCC offers a number of limited-entry programs. Each program has special admission requirements that must be met before you can be admitted. General admission to BMCC does not guarantee acceptance into these programs. The admission requirements may change annually depending upon Oregon state regulations and BMCC policies. For the most current admissions policy information and deadlines, please contact the Admissions Office or the academic department, or consult BMCC's Website.

International Admissions

Blue Mountain Community College is authorized under federal law to enroll nonimmigrant students, and welcomes international students. We provide an affordable education in a safe, comfortable environment. To be considered for admission as an international student, you must:

1. Complete BMCC's International Application for Admission packet.
2. Submit an official TOEFL score report (minimum 550 paper-based, or 97 internet-based). Students whose native language is English will not be required to submit TOEFL scores; however, they must have the ability to benefit from instruction based on scores from the COMPASS placement assessments.
3. Additional requirements for admission, and for obtaining an I-20 visa, include:
 - Proof of adequate funds for the student's studies.
 - A complete set of documents for all of the student's previous and current studies.
 - Proof of health insurance.

International students must be enrolled full-time (12 or more credits) and successfully complete 12 or more credits each term to remain in good standing with the U.S. Citizenship and Immigration Services (USCIS).

For more information, or to receive an international student application packet, please contact the Admissions Office; email getinfo@bluecc.edu; or visit the International Student Admissions page on BMCC's Website. You will be notified by mail after all of the application materials are received and verified.

Non-Degree Admissions

If you wish to enroll for courses at BMCC but not obtain a degree or certificate, you are required either to:

- Create and use an on-line Student WolfWeb account to enroll.
- Submit a completed BMCC Registration form to your local BMCC site.

Every student, whether degree-seeking or not, who intends to take a credited math or writing course is required to take the math or writing placement test. Placement in these courses is mandatory. If you have completed a math or writing course, you will need to submit either an unofficial grade transcript or placement assessment from your prior college (test must have been taken within the last two academic years). Once you have submitted your documentation to our Advising and Testing Center on the Pendleton campus, an override will be applied to your student record within two business days. Note: You must have passed your math or writing course with a grade of "C" or higher. If you have been out of school for two or more years, you must take the math or writing placement assessment.

Placement Assessment

Placement assessment is required if you intend to take a math or writing course and have not already taken a math or writing course at a college or university. In addition, degree-seeking students may need to complete placement assessments for reading and computer literacy. You are encouraged to review the topics covered in the placement assessment. Our testing center

General Information

can recommend a variety of study tools. BMCC uses a self-paced, computerized assessment designed to determine your level of academic ability in each of these subject areas. The scores are used to assist you and your advisor in placing you in the correct course.

If you have taken either a math or writing course from another college or university, you will need to provide the Advising and Testing Center with a copy of your unofficial grade transcript to determine proper placement in math and or writing courses at BMCC. Note: You must have passed your math or writing course with a grade of "C" or higher. If you have taken a math and/or writing assessment from another college within the last two years, you may submit evidence of it to the Advising and Testing Center on the Pendleton campus in lieu of having to take the assessment at BMCC. Placement assessment scores are valid for two years. If you took a math and/or writing placement assessment at BMCC or another college more than 2 years ago and have not taken a math and/or writing course since that time, you will be required to take the placement assessment in that subject area.

All BMCC locations administer placement assessments. Dates and times for testing are posted on the college Website, or you can call 541-278-5931. There is a \$10 fee for taking the initial placement assessment for math, writing, reading, and computer literacy. Students wishing to re-take the assessment in a subject area will be charged \$5 for each retest.

The scores will be uploaded each day to provide the most current information to your advisor to assist you in planning an appropriate course schedule. BMCC does not use placement assessment scores to determine admittance to the college.

If you disagree with your placement recommendation for writing, you may be referred to the academic department for further placement advising and possible further testing. Should you disagree with your math placement you may request to take a challenge test.

To request a placement assessment with accommodations due to a documented disability please contact the assistant director of advising, testing and student disability services at 541-278-5931.

You may also meet this requirement by taking one of the following courses and completing it with a grade of C or higher: CS120, BA131, ED235, and AGR111. Please work with your advisor to determine which option best fits the needs of your degree.

Immunizations

The Oregon Department of Health requires community college students born on or after January 1, 1957, to have two doses of measles vaccine before participating in clinical experiences in allied health, nursing, and human services programs; practicum experiences in education and child care programs; and intercollegiate sports. If you are enrolling in the nursing program and in some health programs, you may also be required

to be vaccinated for Hepatitis B prior to entering any clinical experiences. For details about these requirements, contact the department that oversees the program in which you plan to participate.

Adult Basic Education (ABE) and General Educational Development (GED) Admissions

These programs are open to non-high school graduates who are at least sixteen years of age and not enrolled in high school. Students who are sixteen and seventeen years of age must provide the college with a release from the high school district in which they reside according to O.R.S. 339.030. For more information, contact the Department of College Preparatory Programs at 541-278-5795. More information can be found on page 33 of this catalog.

Registration Information

If you are a certificate- or degree-seeking student, you must be cleared to register through your academic advisor in order to register. If you do not have access to the Internet or if you need assistance in registering for courses, you may visit any BMCC location to register. Students will be issued a BMCC email account, which will be used for official and informative communications. Students are responsible for checking their BMCC email account frequently.

The maximum number of credits a student can register for in a term is 21 credits. Should you wish to enroll for more than 21 credits you will need to complete a Schedule Change form and submit it to the Registrar's office for approval.

BMCC does not allow late registration. You may add courses up through midnight of the day prior to the first day of the course. Please see chart below.

Day Course Meets for the 1st time	Last Day to Add (as of midnight)
Monday	Sunday
Tuesday	Monday
Wednesday	Tuesday
Thursday	Wednesday
Friday	Thursday
Saturday	Friday

For more information on registration dates and timelines, see the calendar found in this catalog or visit our Website.

For special registration assistance due to a disability, please contact the assistant director of advising, testing and student disability services at 541-278-5958.

Degree-Seeking Students

If you are a new or returning degree-seeking student, you will need to make an advising appointment with an academic advisor. To make an appointment, call the Advising and Testing Center in Pendleton at 541-278-5931 or contact the BMCC location closest to you. You may also contact your advisor or academic

General Information

department directly to set up an advising appointment. The advising process will include information regarding registration for classes.

All new degree-seeking students are required to take HD109 Academic Planning, during their first term of attendance. Students will be blocked from registration for a subsequent term until they have registered for and successfully passed HD109 or its equivalent. Alternative course options at BMCC are: AGR101, BA109, CJ101, CET111, or ED100.

Non-Degree-Seeking Students

If you wish to enroll in courses at BMCC but not to obtain a degree or certificate, you may register online using the Student WolfWeb link found on BMCC's Website. If you do not have access to the Internet or need assistance in registering for courses, you may visit any BMCC location to register in person. You are considered to be registered when the college receives your completed registration unless the college notifies you that the courses for which you registered are full or cancelled or that you have been placed on a waitlist.

Priority Registration

BMCC uses a priority registration process at the start of each pre-registration period. Credits considered for pre-registration purposes include credits completed at BMCC and evaluated credits from other colleges. The Priority Registration schedule is available on our Website; select the link for Calendars.

Course Numbers

Generally, courses with letter prefixes apply toward degrees and certificates, and courses with 100 and 200 numbers are college transfer courses; those numbered 200 to 299 are considered sophomore-level courses. Be sure to check the degree requirements for the certificate or degree you are seeking to ensure that the course you are taking will be counted.

Credits

In order to earn an associate's degree in two years, you should enroll for an average of 16 college-level credits in fall, winter, and spring terms. If college preparatory courses are required, the number of credits each term would increase accordingly. Curriculum and program requirements described in this catalog provide more information on the program or degree of your choice.

If you are participating in intercollegiate athletics, you must complete and pass at least 12 credit hours each term for eligibility purposes. You are encouraged to visit with BMCC's athletic director and/or our coaches for detailed eligibility requirements.

Attendance

Blue Mountain Community College believes that it is the student's obligation to attend and participate in classes and that there is a direct correlation between participative attendance in

a course and successful completion. Individual courses may have their own attendance policies. The college has an administrative drop process for the first five days of class each term. The administrative drop process is not guaranteed. If you do not intend to continue in classes, you must not assume that you will be automatically dropped for non-attendance. To drop a course or courses, you must drop your courses online or by submitting a completed Schedule Change form to any BMCC location for processing. You will be responsible for payment for all courses that you have not dropped as of the end of the 100% refund period.

Auditing Classes

You may audit a course at a reduced tuition rate. If you register for a course online and wish to audit it, you must complete a paper Schedule Change form requesting the audit option. This status cannot be changed after the 100% refund period. Courses taken as an audit status do not count as credits attempted in financial aid award calculations, and the AU (audit) status does not count in calculating GPAs. The audit indicator AU indicates a registration status, not an evaluation.

Dropping/Withdrawing from Classes

Definitions:

Drop: When you remove a course from your schedule before the end of the 100% refund period for that course. If you drop a course from your schedule, it will not show up on your grade transcript. **Note:** Courses that are less than a full term in length have different refund periods. These dates are indicated on your schedule as "last date to drop and pay."

Withdraw: When you remove a course from your schedule after the 100% refund period for that course. If you withdraw from a course, it will show up on your grade transcript with a status of W to indicate that you withdrew from that course. In addition, students are responsible for all tuition and fees associated with the course or courses they withdraw from. **Note:** Courses that are less than a full term in length have different withdrawal deadline dates.

To drop or withdraw from a course, log in to your student account on the Student Wolfweb from BMCC's Website. If you are having problems online, you may complete and return a Schedule Change form to any BMCC location for processing.

If you leave BMCC without following the withdrawal procedures described above, you are responsible for the final grades received and associated tuition and fees for those course or courses.

Waitlisted Courses

If you have been placed on a waitlist, you will be notified by email (sent to your assigned BMCC email account) from the Office of Instruction if space becomes available in the course before 5:00 p.m. on the day before the first day the course meets. It is your responsibility to ensure your status in any waitlisted courses.

Academic Information

You may not attend the course unless you have been officially admitted to the course. To check the status of your waitlisted course check your term schedule on the student Wolfweb and be sure to check your BMCC student email.

Withdrawal from College

If you find you can no longer attend classes, you should officially withdraw from school. Before doing so, please be sure to work with your advisor to determine if other options are available to you. The last day to withdraw from classes without receiving a grade is listed on the academic calendar. **Note:** Courses that are less than a full term in length have different withdrawal deadline dates.

If you are receiving financial aid, be aware that totally withdrawing prior to completing more than 60% of the term can result in your owing money back to the U.S. Dept of Education or to BMCC. Please refer to the Financial Assistance section of the catalog for further information.

NOTE: A student who is registered is considered to be in attendance. Non-attendance or non-payment does not constitute official withdrawal, nor does it release you from the obligation to pay for your course or courses.

Withdrawal for Military Duty

The following guidelines apply when a veteran, Reserve, or National Guard student is called to active duty for military purposes during the term (This does not include being called to start basic training):

- You may drop courses and receive a full tuition and fee refund.
- You may, at your discretion, elect to complete courses after making special arrangements with your instructor(s) to create an incomplete contract allowing reasonable time to complete the academic work required.

Please contact the Service Center in Pendleton for further information at 541-278-5759, or send an email to: getinfo@bluecc.edu. If you are receiving financial aid you need to refer to the Financial Assistance section of the catalog for further information regarding withdrawals.

Academic Information

Grading System

The quality of your work is measured by a system of grades and by computed grade-point averages. All assigned courses, regardless of curriculum, are included when determining a cumulative grade-point average while attending BMCC.

The grading system consists of the following:

Grade		Points
A	Superior	4
B	Above Average	3
C	Average	2
D	Below Average	1
F	Failure	0
FA	Failure – Attendance	0
P	Pass	0
NP	No Pass	0
INC	Incomplete	0
R	Repeat	0
W	Withdraw	0

Only grades of A, B, C, D, F, and FA are considered in the computation of grade point averages. All other grades will be disregarded in the calculation of your GPA; however, other grade marks and enrollment status will affect financial aid and athletic eligibility.

Grade Point Average (GPA)

Your grade point average (GPA) is calculated as follows: take the number of points from the table above for each grade that you received and multiply it by the number of credits for that course; then repeat the process for each course in which you received a grade of A, B, C, D, F, or FA. Add all of the results together and then divide by the total credit hours in which grades A, B, C, D, F, or FA were received. Note: If a course is repeated, only the most recent grade is used in computing the GPA unless the course is designated as repeatable in the Course Descriptions section of this catalog.

Grade Definitions:

A/4: Superior: An indication that the student has met the state outcomes and course criteria at the highest level, demonstrating mastery of required knowledge and skills.

B/3: Above Average: An indication that the student has meet the stated outcomes and course criteria at a high level, demonstrating mastery of most required knowledge and skills.

C/2: Average: An indication that the student has met the stated outcomes and course criteria with sufficient mastery of enough of the required knowledge and skills to be capable of success in other courses that require this course as a prerequisite.

D/1: Below Average: An indication that the student has only minimally met the stated outcomes and criteria of the course but may not have sufficient mastery of enough of the required knowledge and skills to be capable of success in other courses that require this course as a prerequisite.

F/0: Failure: An indication that the student has participated in the course but, has not adequately met the stated outcomes and criteria of the course.

FA/0: Failure-Attendance: An indication that the student did not participate (either by attendance or by online participation)

Academic Information

in a significant amount of the course and, as a result, has not adequately met the stated outcomes and criteria of the course. Instructors assigning this grade must provide a Last Date of Attendance (LDA) to satisfy Federal Title IV aid requirements.

INC (Incomplete)

Your instructor(s) may assign an incomplete grade when the quality of your completed work is satisfactory but the course has not been completed for reasons acceptable to the instructor. At least sixty percent (60%) of your course work must be completed for an incomplete grade to be given. An incomplete grade must be made up within a maximum of one calendar year from the date that the incomplete appears on the grade report; however, you and your instructor may choose a shorter time in which to complete the course work. Incomplete Grade Contracts are submitted by the instructor of the course at the time grades are submitted and do not require your signature. The Registrar's Office will maintain and monitor INC contracts for the college. If your instructor does not return your completed INC contract to the Registrar's Office providing your final grade earned by the contract deadline date, the alternative grade indicated on the contract will automatically be entered into your permanent record. It is your responsibility to complete the work agreed upon and the instructor's responsibility to submit the final grade earned in a timely manner to the Registrar's Office. Grade changes after the end of the contract will not be processed without prior approval from the vice president of instruction.

P/NP (Pass/No Pass)

If you wish to use the P/NP option you must:

- Elect to do so by the end of the fourth week of the term. Once you declare the P/NP grading option, no changes in grading can be made.
- Submit an application for the P/NP grading option to the Registrar's Office. Before submitting this form to the Registrar's Office, you must first collect the signature of the instructor of the course for which you are exercising this option.

You may apply a maximum of 12 program or elective credits with a grade of P toward a degree at BMCC. This number would include pass grades earned in regular BMCC classes and those earned from another college or university. This number does not include pass grades earned in course work with obligatory pass grades or advanced placement credits transcribed as pass.

The P/NP option is not available in courses being repeated by the student, in courses required for a degree, or in courses in the core area required for an AAOT/AS degree (pass grades would be accepted in advanced placement test credit.).

The P grade denotes a level of accomplishment of C or better.

Pass grades from other institutions will be examined on an individual basis. If the registrar determines that the course meets or exceeds BMCC requirements, then credit may be granted.

If you are planning to transfer to a four-year institution, you should determine the policy of that school before electing the

P/NP option at BMCC.

When computing credits earned and GPA, the Registrar's Office treats the P/NP credits as follows:

- The pass credits will be transcribed as credits earned and will not be computed in the grade point average.
- The no pass credits will show on the transcript as credits attempted and will not be computed in the grade point average.

R (Repeat)

Assigned when you have repeated a course that is not repeatable for credit. If you repeat a course, the college will count the grade received for your most recent attempt. All other attempts at the course where a grade of A, B, C, D, F, FA, or INC was given will be changed to a grade of R on your transcript.

Enrollment Status

In addition to the above grades, other enrollment-status indicators may be entered on your grade report or transcript. These include AU (audit), CIP (course in progress), MSG (missing grade), and W (withdrawal).

AU (Audit)

This is NOT a grade. It is an enrollment status and must be declared at the time of registration for the course. See the Audit Policy section below for more information.

CIP (Course in Progress)

CIP is an enrollment status used when a course is scheduled to continue from one academic term into the next. The CIP is not a terminal grade but is, rather, a state of progress used until the ending date of the class. At the time a course is scheduled to conclude, the CIP status will be replaced by a grade.

H (High School Diploma)

The designation of H indicates that the variable-hour course was taken as part of a student's adult high school diploma program and that was not completed in a particular term.

W (Withdrawal)

A grade of W indicates that you followed the formal withdrawal procedure and withdrew from the course during the term after the 100% refund period for the term or course. This designation is not used in computing GPA. A W is not punitive. It simply indicates that you withdrew from the course and therefore received no grade.

Audit Policy

If you do not wish to earn college credit, you may audit a course and pay a reduced tuition rate as long as the course is not full. Students who audit are not required to meet any specific academic requirements, but they may participate fully in the activities of the class. If an audit is desired, you must elect this option at the time of registration. Should you wish to take the course for a grade, you must drop the course within the defined drop period and then add the class back as a graded course. You may not change to audit status after the end of the drop period.

Academic Information

Grade Changes

College procedures allow for grade changes up to one year after the end of the term in which the course or courses were taken. Once a grade has been assigned other than an INC, the only acceptable reason for a grade change is instructor or college error. The instructor/student relationship in a given class concludes at the end of the term with the assignment of a grade unless the student receives a grade of INC to allow for the submission of late course work. If you cannot complete all of the course work before the end of the term, you should work with the instructor before the term ends to request a grade of INC. Otherwise, the only way that an instructor can agree to change your grade is for you to submit a grade appeal (see the section on grade appeals). All grade appeals are reviewed by the Office of Instruction and, if approved, sent to the Registrar's Office for final processing.

Grade Appeal Process

The responsibility for assigning grades rests with the individual instructor, who uses his or her best judgment in accordance with what is deemed fair, given the requirements of the course and the work performed by the student.

If you believe that you have been awarded an inappropriate grade by an instructor, you may fill out a grade appeal form and submit it to the Office of Instruction. This will initiate the grade appeal process as outlined in the Student's Rights and Responsibilities Handbook.

Grade Point Average (GPA) Renewal Policy

Students who have previously attended BMCC and have earned poor grades often feel discouraged about trying again. In order to encourage these students, Blue Mountain Community College has established a GPA renewal policy.

If you have returned to BMCC after an absence of at least two years and have subsequently passed two academic quarters of work of at least 12 credit hours each quarter with a 2.00 GPA or better, you may petition the registrar to implement the GPA renewal policy. If the petition is accepted, grades for the term chosen, and for all prior terms, will be changed to no credit (NC). All courses previously taken will remain on the transcript, but the grade point average will be adjusted. A notation will appear on your transcript indicating that the GPA renewal policy was implemented. All courses included in the GPA renewal policy will still be counted as attempted for the purposes of federal financial aid eligibility.

This policy may be used only once. You must be enrolled in at least one credit hour at the time that the policy is implemented. Any courses taken at another college and transferred to BMCC are not subject to the provisions of this policy and are not included in this policy.

Final Examinations

Final examinations are given at the close of each term. You are required to take final examinations at the regularly scheduled

time. Final examination schedules are available online or on the academic calendar found in this catalog. If circumstances warrant taking final examinations at another time, you must make prior arrangements with your instructor.

Academic Achievement Recognition

Blue Mountain Community College recognizes exceptional academic achievement of students at the end of each term and at graduation.

Honor Roll, Dean's List, and President's List

You may attain honor status each term by qualifying for the Honor Roll, the Dean's List, or the President's List. In all cases, you must have completed 12 or more BMCC credits during the term with grades of A, B, C, or D.

Only courses taken at BMCC will count towards academic achievement recognition. Only term GPAs, not cumulative GPAs, are counted for these recognitions.

Levels of achievement are:

- Honor Roll: term GPA of 3.00 to 3.39
- Dean's List: term GPA of 3.40 to 3.84
- President's List: term GPA of 3.85 or higher

Grades of P, NP, and INC do not count toward recognition of academic achievement.

Institutional Academic Progress (IAP)

Institutional Academic Progress (IAP) is the institution's policy regarding a student's academic progress. IAP is not the same as Satisfactory Academic Progress (SAP), which is the status that students using financial assistance must maintain in order to receive funding from financial aid. A student is considered in good academic standing when they are making satisfactory academic progress, such as maintaining a 2.0 GPA each term and passing the required number of credits based on his/her enrollment level, which is 66.67% of the credits they are enrolled in for that term. IAP requires a student to maintain satisfactory academic progress every term of attendance. If a student does not maintain good academic standing he/she may be placed on Academic Alert Status, Academic Warning Status, or Academic Suspension Status. More information about IAP can be obtained by viewing the IAP policy at http://www.bluecc.edu/cat_IAP or by contacting the student success advisor at 541-278-5965.

Nontraditional College Credit

The purpose of awarding credit for prior learning is to acknowledge and validate knowledge, skills, and competencies acquired by students through experience. With the exception of cooperative work experience (CWE) credits (see page 32), students receiving alternate credits are not eligible for state or federal aid for those credits.

The maximum credits that may be earned through a combination of credit by examination, advanced placement (AP), and military credit are no more than 25 percent of the credits needed for a certificate or degree.

Academic Information

Credit by Examination (CBE): To obtain credit for certain courses, you must be enrolled as a BMCC student taking at least one course for credit and satisfactorily pass a comprehensive examination or series of examinations. You may not obtain credit by examination (CBE) for a course at a lower level than one in which you have already demonstrated competency. Some courses are not eligible for this program. If you wish to obtain credit in this manner, you must pay a fee in addition to any other tuition and fees that you may have paid in that term. Contact the Office of Instruction, at 541-278-5969, for more information. Students are limited to 15 CBE credits. CBE credits are reflected on BMCC's transcripts with the exam identifier of (CH) next to the course title. Example: ART204 (CH)

Advanced Placement (AP) Test: You may earn credit for certain courses by taking tests administered by the Advanced Placement (AP) program sponsored by the College Board. Below is a list of approved AP courses, AP minimum scores, and advanced placement action. AP credits are reflected on BMCC's transcripts with a grade of P and with the exam identifier of (AP) next to the course title. Example: ART204 (AP).

To receive AP credit you must:

- Request that your AP scores be sent from the College Board to BMCC. Scores are accepted for up to three years after the exam date.
- Be enrolled at BMCC in at least one credit course.
- Pay the AP course transcription fee of \$10 per course.
- Complete and return an advanced placement credit form to BMCC.

Please contact the Registrar's Office at 541-278-5757 or email getinfo@bluecc.edu for additional information.

AP Exam Taken	AP Score	BMCC Course	BMCC Credit
Art – History	4+	ART 204, 205	8
Art – Studio	4+	ART 101	4
Biology	4+	BI 101, 102, 103	12
Calculus AB	3	MTH 251	4
Calculus AB	4+	MTH 251, 252	8
Calculus BC	3	MTH 251, 252	8
Calculus BC	4 +	MTH 251, 252, 253	12
Chemistry	3+	CH104, 105, 106	15
Computer Science A	4+	CS 161	4
English Language - Composition	3+	WR 121	4
English Language - Literature	3+	ENG104	4
Environmental Science	3+	GS 142	4
Government – U.S.	4	PS 201	4
History – U.S.	3+	HST 201, 202	8
History - World	3+	HST 104, 105	6
Human Geography	3+	GEOG 103	4
Macro Economics	3+	EC 202	4
Micro Economics	3+	EC 201	4
Music Theory	4+	MUS 111, 112	8
Physics B	4+	PHY 201, 202, 203	15
Physics C- Electricity & Magnetism	4+	PHY 201	5
Physics C - Mechanics	4+	PHY 201	5
Psychology	3+	PSY 201	4
Spanish Language	3+	SPAN 101,102,103	12
Statistics	4+	MTH243	4



Academic Information

College-Level Examination Program (CLEP): You may earn credit for certain courses by taking the CLEP exams sponsored by the College Board. Below is a list of BMCC's approved CLEP exams, minimum scores, number of possible credits granted, and corresponding BMCC course equivalencies. CLEP credits are reflected on BMCC's transcripts with a grade of P and with the exam identifier of (CL) next to the course title. Example: ART204 (CL).

To receive CLEP credit you must:

- Request your CLEP scores be sent from the College Board to BMCC. Scores are accepted for up to three years after the exam date.
- Be enrolled at BMCC in at least one credit course.
- Pay the CLEP course transcription fee of \$10 per course.
- Complete and return a CLEP credit form to BMCC.

Please contact the Registrar's Office at 541-278-5757 or email getinfo@bluecc.edu for additional information.

Exam Subject	Minimum Score	Credit	BMCC Course Equivalency
BUSINESS			
Information System & Computer Applications	-	-	No credit awarded
Principles of Management	50	4	BA 206
Principles of Accounting	50	12	BA 211, 212, 213
Introductory Business Law	50	4	BA 226
Principles of Marketing	50	4	BA 223
COMPOSITION AND LITERATURE			
Composition and Literature	50	12	ENG 253, 254, 255
English Literature (with essay)	50	12	ENG 204, 205, 206
HISTORY AND SOCIAL SCIENCES			
American Government	50	4	PS 201
History of the U.S. I	50	4	HST 201
American History II	50	4 OR 12	HST 203 OR w/Part I test HST 201, 202, 203
General Psychology	50	8	PSY 201, 202
Human Growth and Development	50	4	PSY 237
Principles of Microeconomics	50	4	EC 201
Principles of Macroeconomics	50	4	EC 202
Introductory to Sociology	50	4	SOC 204

Military Credit (MIL): Military credit will be evaluated according to American Council of Education guidelines. Typically, credit is considered only when it is equivalent to regular BMCC course offerings. Military credits are reflected on BMCC's transcripts with a grade of P and with the identifier of (MIL) next to the course title. Example: PE185 (MIL).

Transfer Credits

Transferring Credits to BMCC

To have credits earned from other colleges evaluated towards your certificate/degree intent at BMCC, you will need to complete BMCC's Transcript Evaluation Request form. You will also need to request that official transcripts be sent from other colleges to BMCC's Registrar's Office. Official transcripts must include both a signature from the issuing institution and its authorized seal and be delivered to BMCC in a sealed envelope.

In general, BMCC accepts college-level credits earned at regionally-accredited colleges or universities.

Your accepted credits will become a part of your permanent academic record at BMCC and will be noted and posted on your official grade transcript at the time a certificate or degree is earned. Grades earned from BMCC and other colleges that are applied towards a specific certificate or degree will be used to compute your grade point average for that specific program only. In all other cases, only grades earned at BMCC are used to compute your cumulative GPA.

If you have taken the College Level Examination Program (CLEP) or the Advanced Placement (AP) test, request that your scores be forwarded to the Registrar's Office. Exams must have been taken within 3 years of the date you are requesting credit. Credits received for AP, CLEP, or military experience at other colleges and universities will not be accepted. You must have your exam scores and or official military transcripts sent directly to BMCC. For more on CLEP and AP information see page 20-21.

Transferring Credits from BMCC

Up to 120 lower division transfer credit hours earned at a community college may transfer and be accepted toward graduation requirements by colleges and universities of the Oregon University System (OUS): University of Oregon, Oregon State University, Portland State University, Eastern Oregon University, Western Oregon University, Southern Oregon University, and Oregon Institute of Technology.

In order to facilitate a smooth transition from BMCC be sure to discuss transferability of courses with your academic advisor and the school to which you wish to transfer to.

Appeal of Graduation Requirements

If you are pursuing an associate of applied science degree and would like to request a course substitution to meet program requirements, you must discuss this request with your advisor. If the advisor considers the request appropriate, he/she will complete the necessary paperwork, and then obtain the approval

Academic Information

and signature of the vice president of instruction. The Registrar's Office will process the information, once approved, and it will become a part of your permanent record.

Graduation

You are responsible for fulfilling the requirements for graduation and should work with your advisor to ensure that you complete the degree and/or certificate requirements.

As a candidate for graduation, you are encouraged to complete an Application for Certificate/Degree Completion at least two terms before the term in which you expect to complete your program requirements (refer to the academic calendar in the catalog for specific deadline dates). This allows your academic advisor to assist you in selecting coursework necessary to meet your graduation requirements. Completed applications may be submitted to any BMCC location.

Upon the college's receipt and processing of your application form, the Office of the Registrar will notify you and your advisor by email that your degree audit has been completed. Should there be any discrepancy, you and your advisor will be asked to notify the Office of the Registrar. A graduation file will be established for you at that time. Your degree audit becomes your official degree check-off for degree completion purposes.

If you do not complete and return the Application for Certificate/Degree completion and the registrar finds that you have completed all coursework necessary to complete your recorded program of study, the college will grant degrees and/or certificates upon completion of those requirements. Opting out of an institutional award requires completing the appropriate request through the Registrar's office. Multiple credentials may be institutionally awarded within your program of study.

Degrees and certificates become official when recorded on your transcript. Certificates and diplomas will be mailed to the address listed on your application within two months after final grades have been posted and reviewed.

If you do not graduate in the term identified on your application for graduation, the Office of the Registrar will identify your final graduation requirements and will send an email notification regarding your official degree audit to you and your advisor. Your graduation file will be retained with the active files for a period of one (1) year from your intended date of graduation.

If you have not graduated after one year, your application will be returned to your student file and you will be required to reapply for graduation and pay any fees in effect at the time of reapplication.

If you graduate with more than one degree, you must complete a separate application form for each degree you plan to complete.

Computer Literacy Requirement

All students completing a one-year certificate or two-year degree program are required to meet our computer literacy

requirement prior to graduating. There are two options to meet this requirement. They are:

1. Take and pass the IC3 Exam: score an average of 75% or higher on IC3 exams **OR**
2. Take and pass one of the following courses with a grade of "C" or better: **AGR111, CS120, BA131, or ED235.**

Additional Guidelines:

BMCC reviews and updates degree requirements annually. Please note that some of the requirements for graduation may change if your studies are interrupted by one or more years and/or if a course of study extends beyond five years. Depending upon the college certificate or degree, you may be asked to complete updated requirements.

The following table outlines which catalog you may use in determining degree requirements for graduation.

Situation	Catalog of year started	Catalog of year re-started	Catalog of year Graduating
1. Attend concurrently for less than five academic years; AND 2. Break of enrollment of no more than one academic year	X	X	X
Re-attend after a break of enrollment of more than 1 academic year.		X	X
1. Attend concurrently for no longer than five academic years; AND 2. Have no breaks of enrollment of more than one academic year	X		X
1. Attend for longer than five academic years; AND 2. Has break of enrollment of more than one academic year		X	X

Honors at Graduation

Students with exceptional academic qualifications may walk in our commencement ceremony with honors or high honors designation. This designation appears on the commencement program and applies to all of BMCC's degrees and certificates for academic, career, and technical programs. To qualify, you must have attended at least two terms and have earned at least 24 credit hours at BMCC (may be less for programs of less than two years in length). Honors designations are:

Academic Information

- Honors: cumulative GPA of 3.40 to 3.84
- High Honors: cumulative GPA of 3.85 or higher

Only the courses used to meet your certificate or degree requirements will be counted in the cumulative GPA calculation which may include courses accepted for transfer from other colleges. The calculation is performed on all courses completed the term prior to your stated term of degree completion.

Example 1: If the anticipated term of graduation is spring term 2013, your GPA will be calculated at the end of winter term 2013. If you meet one of the above-referenced GPA requirements, you qualify to walk in the spring commencement ceremony with an honors designation.

Example 2: If the anticipated term of graduation is summer term 2013, your spring-term 2013 grades will be used to calculate your GPA. Since the commencement ceremony occurs before spring-term grades are posted, you will not qualify to walk in the 2013 commencement ceremony with an honors designation.

Example 3: If you plan to complete your requirements no later than fall 2012, you may walk in the spring 2012 commencement ceremony but will not qualify to walk with either honors designation. If, however, you believe that you may qualify for honors designation by the end of summer 2012, you could consider walking in the 2012 commencement ceremony.

Commencement Ceremony:

BMCC's commencement ceremony is held each year in June on the last day of spring term. Our spring 2013 ceremony will be held on Friday, June 14, 2013 at 7 p.m. on the Pendleton campus. Students who have completed or will complete all of their certificate and/or degree requirements during or prior to summer 2013 are eligible to participate in our 2013 ceremony. Those completing requirements as of fall 2013 or later are invited to participate in the following year's ceremony.

Final Honors Distinction on Official Transcript

Students with exceptional academic qualifications may qualify to complete their designated program of study with honors or high honors designation. This designation appears on your official grade transcript and may apply to all earned degrees and certificates for academic, career, and technical programs. To qualify, you must have attended at least two terms and have earned at least 24 credit hours at BMCC (may be less for programs of less than two years in length). Honors designations are:

- Honors: cumulative GPA of 3.40 to 3.84
- High Honors: cumulative GPA of 3.85 or higher

Only those courses used to meet your certificate or degree requirements will be counted in the cumulative GPA calculation which may include courses accepted for transfer from other regionally accredited colleges. The calculation is performed on all courses completed through your final term of program completion.

Suspended Programs of Study

If BMCC suspends your program of study and if you are eligible for "teach-out" assistance as determined by the college, BMCC will work with you to help you complete the program within three years. Methods and types of assistance will vary by individual circumstance and will be available only to eligible students. Following the three-year period, if you have not satisfied your degree requirements for that certificate/degree but still wish to obtain a certificate/degree, you must either apply your earned credits to a different BMCC program or transfer them to another institution. Contact the Office of the Registrar to determine eligibility.



Academic Information

College Costs

Tuition and Fees for 2012-2013

Tuition and fees are subject to BMCC Board of Education policy and may be changed at any time. Please refer to our Website, www.bluecc.edu, or call the college at 541-278-5759 to obtain current rates.

Students are considered to be full-time when they are enrolled for 12 credit hours or more.

In-State Residents: For tuition purposes, Oregon residents and residents of California, Idaho, Montana, Nevada, and Washington are charged at the in-state resident rate of \$85.00 for each credit hour, beginning with the summer term of the 2012-13 academic year.

Out-of-State Residents: The tuition rate for out-of-state students (other than the states listed above) is \$255.00 for each credit hour, beginning with the summer term of the 2012-13 academic year.

International Students: The tuition rate for international students is \$255.00 for each credit hour, beginning with the summer term of the 2012-13 academic year.

Senior Citizens: The tuition rate for a resident who is sixty-two years of age or older is fifty percent of the regular tuition rate for credit classes. Fees for credit classes are at the full rates published quarterly in the Schedule of Classes. Seniors who elect to audit credit classes will not be charged tuition; only applicable fees will be charged.

Tuition is not charged for non-credit classes. Fees for non-credit classes are \$29 per class (fees for some courses where materials are especially costly may be higher; these exceptions are noted in the Schedule of Classes).

Normal registration procedures are required.

Generally Applicable Fees:

- ABE, GED, and/or ESL Program Fee (Title II): \$29 for the first class per term, which includes the \$4 Technology Replenishment Fee; \$4 for each additional class per term
- ABE, GED, and/or ESL Course Fee (Non-Title II): \$74 per course, which includes the \$4 Technology Replenishment Fee
- ABE, GED, and/or ESL Orientation Fee: \$10 per occurrence
- Advanced Placement Fee: A transcription fee of \$10 per course
- Agriculture Student Fee: \$30 each term if any agriculture class is taken; limit of one fee per student each term
- Audit Course Fee: Fifty percent of regular tuition and one hundred percent of associated fees
- College-Level Examination Program (CLEP) Fee: A transcription fee of \$10 per course
- Credit-by-Exam Fee: Fifty percent of regular tuition
- Credit for Prior Certification Fee: A transcription fee of \$10

per course

- Credit Recovery Fee: \$30 for each half-credit each term plus a one-time \$20 setup fee
- Deferred Payment Plan Fee: \$20 (required \$100 down payment) Must complete and sign payment plan
- Deferred Payment Plan Late Fee/Interest Penalty: \$15 for each late payment
- Dental Student Fee: \$500 each term
- Distance Education Course Fee: \$85 for each distance education course
- Dual Credit Fee: A transcription fee of \$10 per credit
- Early Childhood Education (ECE) Credit for Prior Learning Fee: A transcription fee of \$10 per course
- ITV Course Fee: \$25 per course for courses at the receiving locations
- Late Payment Fee: 3% of the unpaid balance with a minimum charge of \$10 and a maximum charge of \$75 per term. Fees are assessed monthly until balance is paid in full
- Nursing Student Application Fee: \$50 application fee (Non-refundable)
- Nursing Student Fee: \$300 each term
- Official Transcript Fee: \$5 per transcript;
- Official Transcript Rush Fee: \$30 per destination (same-day processing or "rush" requests)
- Official Transcript Fee (Outside the US): \$55 per destination (includes postage costs)
- Placement Test Fee: \$10 (if a retest is required, an additional \$5 will be charged)
- Replacement Diploma/Certificate: \$5 per item
- Returned-Check Fee: \$35 for each occurrence
- Security Fee: \$3 each term for students taking 1 or more credit hours
- Student Access Fee: \$15 each term for students taking 1 or more credit hours
- Student ID Replacement Fee: \$5 per occurrence
- Student Locker Rental Fee: \$10 per term (Non-refundable)
- Technology Replenishment Fee: \$4 per credit for credit classes; \$4 per course for non-credit classes
- Testing Fees (Agency): \$25 per exam (Non-refundable)
- Testing Fees (Colleges Outside of Oregon): \$25 per exam (Non-refundable)
- Testing Fees (GED No-Show): \$10 each occurrence
- Testing Fees (GED): \$125 per series
- Testing Fees (GED Re-Test): \$25 per exam
- Testing Fees (GED Single Test): \$50 per exam
- Testing Fees - Other: varies (charges are based on the nature of the examination). Contact the BMCC Testing Center at (541) 278-5931 for specific amounts

Other Applicable Fees:

- Associated Student Government (ASG) Student Activity Fee: \$1.50 for each credit hour
- (This fee is approved by ASG and the BMCC Board of Education)

Course Fees: Certain courses may require a fee(s) in addition to tuition. Course-specific fees are published quarterly in the Schedule of Classes.

Academic Information

Course-Specific Fees:

- Applied Music Fee: \$80 for each course
- Art Class Fee: certain courses are assigned a fee of up to \$30
- Diesel Tech Laboratory Fee: \$60 each course
- EMT Fee—Basic A & B: \$160 each term
- EMT Fee—Intermediate-Part A & B: \$130 each term
- Music Class Fee: \$15 piano and/or voice
- Nursing Clinical Fee: \$300 for each course with a clinical component
- Physical Education Fee: \$10 for each course
- Science Laboratory Fee: \$10 for each hour of laboratory per week
- Welding Fee: \$150 lab fee

Note: The College periodically introduces new courses, programs, and/or fees on a pilot basis to meet the needs of the community. These fees may be administratively implemented as needed during the year.

Payment of the stipulated fees by full-time and part-time students registered for academic credit entitles them to all services maintained by the college for the benefit of students. These services include use of the college student union, computer laboratories, library, laboratory and course equipment, materials in connection with courses for which the students are registered, and admission to some events sponsored by the college. By college policy, there is no reduction in fees for students who do not intend to avail themselves of these services.

Paying Tuition

Tuition and fees are payable in full by cash, check, or credit card (Visa or MasterCard) by the end of the fifth class day of each term, or the equivalent percentage of days of terms or classes of varying length. Students may also use financial aid funds or third-party agency funds to pay their tuition and fees if they are eligible for these funds. Payments can be made at any location, by mail, or through the Student WolfWeb.

Deferred (Tuition) Installment Plan: BMCC's tuition installment payment plan is designed to assist students in paying their tuition and fees by setting a reasonable timetable and structure for payment. Students may sign up for this installment plan at any BMCC location or through the BMCC Website. An agreement is not binding for the college until a representative of the Business Office has signed the completed form. Upon signature, BMCC will return a copy of the official signed installment plan to the student. The installment plan will consist of a down payment of \$100 plus a \$20 processing fee. The balance of tuition and fees will be paid in two installments due at the fourth and seventh week of the term (or equivalent for terms of varying length). Late fee penalties of \$15 will be charged for each late payment.

Late Fee/Interest Penalties: Students who have not paid or made payment arrangements by the end of the fifth class day or the equivalent day of terms or classes of varying length will be assessed late fees. The fee is 3% of the balance due assessed monthly until the balance is paid. The minimum charge is \$10, and the maximum charge is \$75 per term.

Stop-Payment Fees for Financial Aid Refund Checks: If you are eligible for a financial aid refund check and it does not arrive at the address indicated on your student account after ten days from the date of issuance by the college, BMCC will re-issue the check without charge to you. If you wish the college to re-issue the check before the 10-day period is over, BMCC will charge you a \$35 stop-payment fee.

Financial Holds: If your student account is not paid in-full by the beginning of pre-registration for the upcoming academic term, a financial hold will be placed on your account preventing you from registering for the upcoming term. Other financial holds may be placed on your account if items are not returned to departments at the College (such as the Library or the MAC Center) or if you have a bad address listed on your Student WolfWeb account. Please contact the Service Center on how to resolve the financial hold on your account.

Tuition Refund Policy

Students who withdraw from the College or from college courses, and who have complied with regulations governing withdrawals are entitled to certain tuition refunds depending on the time of withdrawal. Tuition refunds are calculated as follows:

- First five (5) days of the term for an 11-week course or the equivalent day of the term for courses of varying length. = 100%
- After the first five (5) days of the term for an 11-week course or the equivalent day of the term for courses of varying length. = 0%

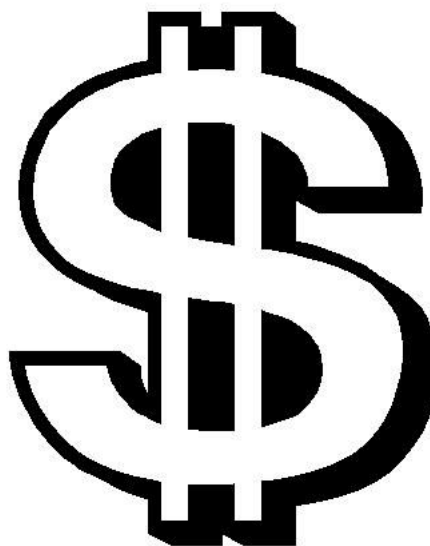

Academic Information

Financial Assistance

Federal School Code: 003186

Blue Mountain Community College's Office of Student Financial Assistance is located in Morrow Hall on the Pendleton campus and can be accessed through the Service Center. Please check the BMCC Website for hours of operation. You may contact the Service Center by phone at 541-278-5759 or the Office of Student Financial Assistance by email at finaid@bluecc.edu. The Office of Student Financial Assistance staff and the Service Center Staff are available to students for assistance in applying for and receiving the following sources of financial aid:

- Federal and state aid
- Certification of veterans' education benefits
- Student employment
- BMCC tuition scholarships (athletic, music, drama, and skills challenge)
- Miscellaneous private scholarships

Federal and State Aid

BMCC participates in the following types of federal and state aid:

- Federal Pell Grant
- Federal Supplemental Educational Opportunity Grant (FSEOG)
- Federal Work Study
- Federal Direct Subsidized and Unsubsidized Stafford Loans
- Federal Direct PLUS (Parent Loans for Undergraduate Students)
- Oregon Opportunity Grant (OOG)

Applying for Federal and State Aid: Students must submit a Free Application for Federal Student Aid (FAFSA) for each year in order to receive aid. Students may apply online at www.fafsa.gov, or they may complete and submit a paper application. Be sure to include BMCC's Federal School Code (003186) so that BMCC receives the FAFSA information. Applying online can reduce the amount of time for processing financial aid by approximately eight weeks. Note: January 1 is the first day of the financial aid application period for the next academic year. Refer to the "Dates & Deadlines" link on the BMCC Financial Assistance Webpage for more details.

Disbursement of Aid: Aid is disbursed (credited to student accounts) one week prior to the start of a term so that students can access their funds for the purchase of books in the BMCC bookstore. If students have a credit balance on their student account after all charges have been covered, including any books they have purchased, they will receive a check for the balance of their financial assistance funds. Checks are mailed by the 2nd Friday of the term. For actual disbursement dates, refer to the "Dates & Deadlines" link on the BMCC Office of Student Financial Assistance Webpage for more details.

Aid-Ineligible Courses: For some degree programs, certain courses may not count toward financial aid eligibility. Students should work closely with their academic advisors and take only courses that apply toward their stated degree intent.

Mid-Year Transfer Students: If you transfer to BMCC during the academic year and received financial aid at the previous college, you should be aware that the BMCC financial assistance office will adjust your award amount accordingly to avoid an overpayment. For most mid-year transfer students, the federal or state aid award at BMCC will be reduced by the amount of aid received at the previous college.

Taking Courses at BMCC and Another Institution (Co-enrollment): If you are planning to take courses from BMCC and another college during the same term, you must complete a consortium agreement form and provide proof of registration for each class taken at another college. Once processed, the consortium agreement is valid for one academic year; however, you must submit proof of registration each term of that year for each college from which you plan to take courses. Forms and additional information regarding co-enrollment are at www.bluecc.edu/students_fa_dual.

Second Degree: If you have received an associate's, bachelor's, or master's degree and wish to receive financial aid from BMCC, you must complete a Length of Time (LOT)/Second Degree appeal and submit it, along with appropriate documentation, to the Office of Student Financial Assistance. You will be notified in writing of the decision made. This process does not guarantee an award. Depending upon the kind of degree that you already hold, your aid, if awarded, may be limited to loans.

Satisfactory Academic Progress (SAP): The Office of Student Financial Assistance is responsible for ensuring that all students who receive federal and state aid are demonstrating satisfactory progress toward the completion of their educational programs. The office will review a student's SAP before making awards each academic year and again at the end of each term. The standards of SAP apply for all state and federal financial assistance programs including Federal Pell Grant, Federal-Work Study (FWS), Federal Supplemental Educational Opportunity Grant (FSEOG), Direct Loans (Stafford and PLUS) and Oregon Opportunity Grant (OOG).

Students are evaluated on all of the following standards:

- Cumulative Credit Completion Rate (cCCR).
- Cumulative Grade Point Average (cGPA).
- Maximum time frame (150% Rule).

Students must meet all three progress requirements (cCCR, cGPA, and be within the maximum time frame) to remain in good standing. Students not meeting the requirements will be placed on Financial Aid Warning or Suspension status during their next term of enrollment and will receive, in writing from the Office of Student Financial Assistance, a notice of such standing.

For additional information regarding this policy and for more detailed information about financial aid, please visit BMCC's Website or contact the Office of Student Financial Assistance.

Total Withdrawal and Return of Federal Aid: If you withdraw from or quit attending *all* classes in a term before completing more than 60.01 percent of the term for which you received aid, BMCC will recalculate your aid award based upon the percentage

Academic Information

of the term completed. For example, if you withdraw after completing only 30 percent of the term, you will have earned only 30 percent of your federal aid received (other than Federal Work Study). You and/or BMCC, as determined by college and federal rules, must return (repay) to the federal government the remaining 70 percent of the federal funds received. This policy applies to all students receiving federal Title IV aid who withdraw, drop out, or are suspended from BMCC. Types of federal Title IV funds that students can receive while attending BMCC included in this policy are: Federal Pell Grant, FSEOG, and Federal Direct Stafford Loans.

For additional information regarding this policy and for more detailed information about financial aid, please visit BMCC's Website, click on "Students," "Financial Assistance," then "Policies."

Other Financial Assistance

Foundation Scholarships

The Blue Mountain Community College Foundation offers scholarships to both full- and part-time students. Scholarship information and scholarship applications are posted on the college Website. Most full-time scholarships are awarded during spring term for the next academic year. Scholarships for part-time students may be available each term. An applicant must be enrolled before a scholarship can be awarded. Stipulations concerning financial need, credit hours, grade point average, and area of study may apply.

The BMCC Foundation posts information on its scholarships as well as information that it receives from local civic groups; fraternal organizations; and state, regional, and national agencies. For further information visit our scholarships web page www.bluecc.edu/apps/scholarships/scholarships, or contact 541-278-5775.

Military Educational Benefits

BMCC assists veterans and family members of veterans with three primary types of benefits:

- United States Department of Veterans Affairs Educational Benefits – Students apply for these benefits through the VA, and the BMCC Financial Assistance Office certifies them. Benefits are paid directly to the student by the VA.
- Oregon Veteran Educational Aid Program (Tuition Assistance) – Students apply for this benefit through the State Veterans' Affairs Office, and the benefit is paid by the state directly to the school to be applied towards the students' tuition and fees.
- BMCC tuition waivers for military and qualifying family members – students apply for one of these three waivers through BMCC. Forms are available on the BMCC Website. The BMCC Registrar's Office reviews these requests.

Since each of these three types of benefits are administered by different agencies and/or offices, they have distinctly different processes for accessing. The following is a guide for requesting and receiving each of these benefits:

VA Educational Benefits:

General Information about applying: In order to receive VA educational benefits, veterans must:

- Take the BMCC placement test to determine proper course placement before enrollment
- Be assigned an academic advisor
- Be pursuing a BMCC degree or certificate

To begin receiving educational benefits, veterans must:

- Apply for VA Education Benefits online
- Complete 2011-2012 Enrollment Certification
- Read the Statement of Rights and Responsibilities

Additional documents needed:

- Those discharged from active duty also provide a copy of 'Certificate of Eligibility' letter from the VA or DD-214
- Active members of the National Guard and Reserves also provide a copy of their Notice of Basic Eligibility (NOBE)

Return forms to:

- Mail: BMCC Veterans Certifying Official, P.O. Box 100, Pendleton, OR 97801
- Email: finaid@bluecc.edu
- Fax: 541-278-5889

Processing: Please allow two to three weeks for processing and certification of your enrollment to the VA. Benefits are paid directly to the student. It is important that you are aware of tuition payment deadlines and payment options.

Pay Table: Rates of pay depend on the veteran's chapter and on his or her enrollment level. BMCC will inform the VA of any enrollment changes during the term, which may result in adjustments to the monthly allowance. It is the veteran's responsibility to report any changes to the veterans certifying official.

Pay rates are updated each year, usually in October. Veterans may be eligible for additional tuition assistance, or "kickers." Contact the VA directly at 1-888-442-4551 for specific payment questions.

[Chapter 30](#) - Discharged from Active Duty

[Chapter 1606](#) - Selected Reserve

[Chapter 1607](#) - Reserve Educational Assistance Program (REAP)

[Chapter 35](#) - Survivors' and Dependents' Education Assistance

[Chapter 33](#) - Post 9/11 GI Bill

Advance Pay Request: Veterans who need financial assistance to begin classes may request advance pay for the first term. Requests must be made four to six weeks before the beginning of the term. With advance pay, veterans are paid for the first two months of the term; however, the VA payments are based on the number of days that the veteran was enrolled for a given month. For example, if fall term begins the last week of September, the advance paycheck would be for part of September and all of October. The advance check is sent directly to the BMCC Business Office.

Academic Information

Certification Periods: The veterans certifying official will certify based on BMCC's official [academic calendar](#). Some courses vary in length. The veterans certifying official will certify enrollment according to each course's beginning and ending dates, which may affect the rate of pay.

Satisfactory Academic Progress (SAP): The veterans certifying official at BMCC is responsible for ensuring that all students who receive VA benefits are demonstrating satisfactory progress toward the completion of their educational programs. The office will review a student's SAP before making awards each academic year and again at the end of each term. The standards of SAP are the same as those for all state and federal financial assistance programs listed above.

Oregon Veterans - Tuition Assistance

The Oregon Department of Veterans' Affairs provides educational benefits for pursuit of approved training courses.

Benefits will be paid for as many months as the veteran spent in active service, up to a maximum of 36 months. Veterans who qualify for the program are entitled to receive up to \$150 per month.

ODVA's educational aid will not be paid if the veteran is currently receiving federal educational benefits under any federal act.

Payment Amounts:

- Full-time students are entitled to receive up to \$150 per month.
- Part-time students are entitled to receive up to \$100 per month.
- School criteria determine full-time and part-time status.

Eligibility Requirements:

- Active duty in the Armed Forces of the U.S. for not less than 90 days; and
- Released from military service under honorable conditions; and
- Resident of Oregon when applying for state educational aid; and
- Citizen of the United States; and
- Served during the Korean War (June 25, 1950 to January 31, 1955) or after June 30, 1958.

Getting Started:

Eligibility forms, application forms, and counseling about Oregon educational aid for veterans are available by calling 1-800-692-9666, or go to www.oregon.gov/ODVA/BENEFITS/OregonEducationBenefit.shtml

BMCC Military Tuition Waivers:

BMCC, with the purpose of enhancing student support while providing a premier learning environment, provides military tuition waivers to honor returning veterans and the dependents of deployed, disabled, and fallen military service members.

Definitions:

Veteran: any Oregon resident who is a member of the United States armed services and is currently on active duty or is an Oregon resident who has been honorably discharged. Veterans

will register in the same manner as all other students.

Disabled Veteran: 100% disabled as a result of a military-connected disability as certified by the United States Department of Veterans Affairs or any branch of the Armed Forces of the United States, or fallen while in military service.

Dependent: spouse or any unmarried child under the age of 24 of a deployed veteran, a 100% disabled veteran (as described above), or a veteran who died as a result of military connected disability or service.

Guidelines:

This tuition waiver is for 50% of the tuition costs for credit courses during the student's first year of his/her degree program at BMCC, unless these costs are covered by the Montgomery GI Bill or tuition assistance.

The student must be taking a minimum of three credits; the tuition waiver will apply to a maximum of twelve credits per term. All credits taken over twelve in a term will be at full cost to the student. The student must apply for the tuition waiver each term.

The student's year will begin with the first term in which the student commences degree course work and will end after four consecutive terms. If a student chooses to attend for fewer than the four given terms, his/her eligibility is still exhausted after the fourth consecutive term.

This waiver will not cover fees and AFEES (i.e., fees for non-credit classes).

If the student is co-enrolled, this tuition waiver covers only the cost of BMCC courses.

The waiver cannot exceed the number of credits required for an associate's degree.

The prospective student must reside within the BMCC service area, which includes Umatilla, Morrow, Baker, Grant, and Wallowa counties.

If the veteran is called to active duty, he/she will have the choice of continuing course work via distance education or re-entering the program upon his/her return. Returning veterans who were enrolled in limited-entry programs will be allowed re-entry if the program allows and if the curriculum has not undergone significant changes.

To Apply:

Veterans: To receive a tuition waiver, each term a veteran must present current identification card or discharge papers (DD214) to the Registrar's Office along with the completed waiver form.

Dependents: To receive a tuition waiver, each term the prospective student must present proof of the residency and death or 100% disability of the Oregon service member, proof of his/her campaign service (DD Form #214), and proof of his/

Academic Information

her dependent status to the Registrar's Office along with the completed waiver form, which can be found on BMCC's Website at www.bluecc.edu/admissions_forms.

Important links:

- GI Bill Information - www.gibill.va.gov
- GI Bill WAVE - Web Automated Verification of Enrollment - www.gibill.va.gov/wave/
- Oregon Department of Veterans' Affairs ODVA - www.oregon.gov/ODVA/
- ODVA Educational Aid for Veterans - www.oregon.gov/ODVA/BENEFITS/Education.shtml
- DD 214 Requests Online - www.archives.gov/veterans/evetrecs/

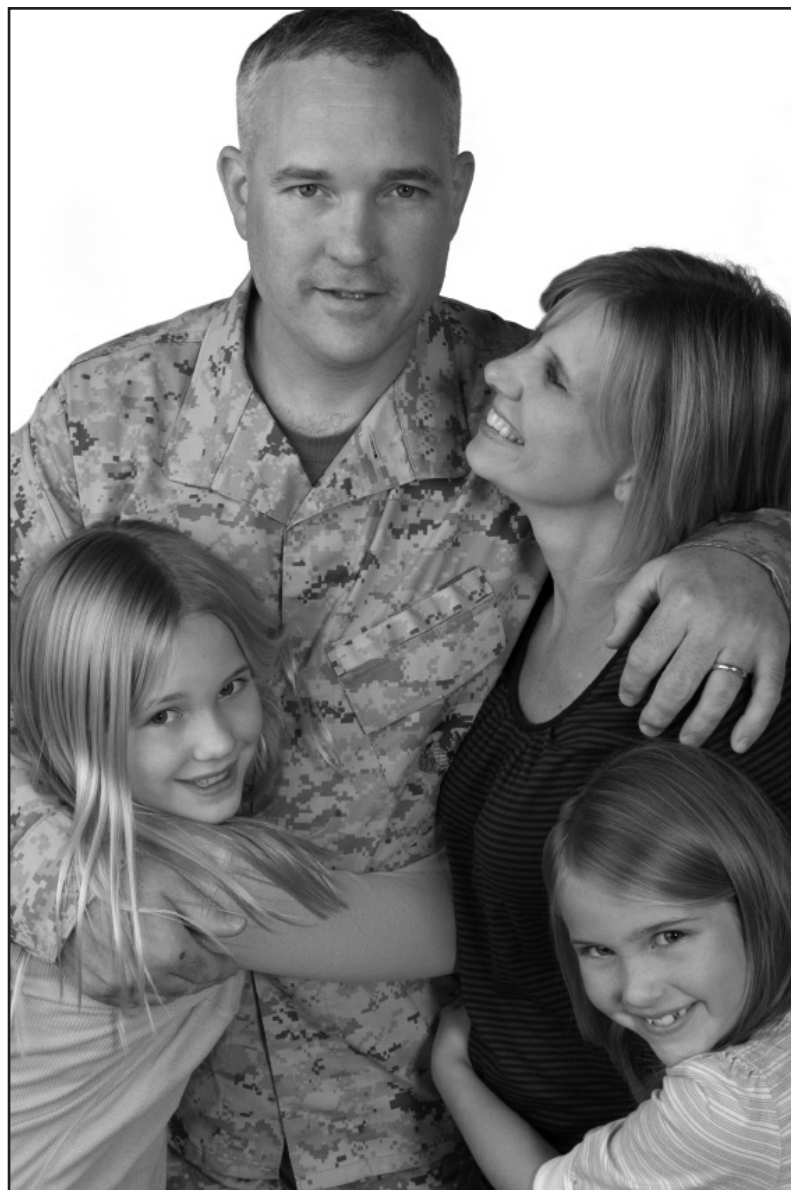

Services and Programs

Academic Services

Testing Services

Testing services are available at all BMCC locations. Services will vary by site. Contact the BMCC center nearest you for schedules, appointments, and details.

The testing centers provide placement testing services to help a diverse student population successfully achieve a variety of educational goals. The testing centers also provide test proctoring services for distance education students, special accommodations testing, and GED testing. In addition, the Testing Center on the Pendleton campus provides testing services for a variety of tests for professional licenses and certifications. Information on other testing services is available upon request.

Placement assessments are required for all new certificate- and degree-seeking students. You may take our COMPASS placement assessments at any BMCC location. You must take assessments for math, writing, and reading. The cost for the assessments is \$10. Transfer students that have taken a math or writing course may submit their unofficial transcripts to the Advising and Testing office in order to waive one or more of these assessments.

Academic Advising

The Academic Advising Philosophy at BMCC states, "Academic advising is a collaborative process through which advisors assist students with timely, meaningful educational planning that is compatible with the students' life goals. The advisor serves as an advocate and resource in an interactive partnership with the student. Advising encourages students to think critically, seek out resources, and develop action plans."

To help ensure student success, BMCC requires all degree-seeking students, whether full- or part-time, to work with an advisor to plan and develop their academic career paths. Advisors work with students to help ensure they are taking classes that apply to their chosen degree plan and that are appropriate for the students' level of readiness and preparedness for a variety of courses. Advisors also help students navigate the complex world of degree audits, graduation, academic support systems, and transfer information.

An advisor will be assigned to students seeking a degree; however, academic advising is available for all students at BMCC, whether degree-seeking or not, to help them effectively plan to meet their educational goals. There is an advisor for every academic program at BMCC. Students planning to transfer to a four-year college or university can find catalogs, applications, scholarship information, and other helpful information from all Oregon University Systems schools and other colleges in the Pacific Northwest by contacting the advising department at the Pendleton campus or by visiting the BMCC Library.

To see an advisor, you can call or stop by the advising center in Pendleton (Morrow Hall, room 118), call 541-278-5931 in

Pendleton, or contact the center nearest you to have an advisor assigned. You can set up appointments directly through your assigned advisor, or the centers can set them up for you.

HD109 Academic Planning

First-year experience courses have shown to benefit student success at colleges across America. Students who successfully complete a first-year experience course are more likely to complete and attain their academic goals. Therefore, BMCC has designed and implemented a 1-credit course entitled HD109 Academic Planning. HD109 was created to improve the success rate of our students and to help with transition into college.

All degree- and certificate-seeking students are required to take HD109 Academic Planning or an approved alternative within the first term of enrollment. Approved alternatives include: ED 100, AGR 101, CET 111, and CJ101. Students who qualify for a waiver of this requirement are:

- Students with a minimum of 24 transfer credits from another institution and a cumulative GPA of 2.0 or greater
- Students who have minimum of 12 or more credits at BMCC with a cumulative GPA of 2.0 or greater (not including credits earned while in high school).
- Students with an associate's, bachelor's, or master's degree

Students who qualify for a waiver must submit a waiver request form along with supporting documentation to the BMCC Pendleton Service Center. The registrar or the assistant director of advising, testing, and student disability services, or their designee, will review and process approved waivers.

Designated program-specific introductory course can be substituted for HD109 Academic Planning. Work with your program advisor to determine the most appropriate academic planning course to meet your needs.

Bookstore

The BMCC Bookstore is located adjacent to the library in Pioneer Hall on the BMCC Pendleton campus and provides services to students at all BMCC locations. Bookstore products and services include new and used textbooks, in-store and on-line textbook rentals, study aides, calculators, school and art supplies, sundries, and stamps. The bookstore also offers a wide selection of clothing, gifts, snacks, and beverages. Academic pricing on computer software is also available to those who qualify.

Textbooks are also available at the centers in Baker City, Milton-Freewater, and Hermiston for classes held at those locations. If you are taking classes at any of these locations and have questions about textbook purchases, please contact the local center directly. Please contact the bookstore for book refund and textbook buyback policy.

Textbooks and merchandise can be ordered online at www.bookstore.bluecc.edu. For more information or questions, please contact the bookstore at 541-278-5733 or e-mail bookstore@bluecc.edu.

Service and Programs

Copy Center

The BMCC Copy Center is located in the bookstore in Pioneer Hall on the Pendleton campus and is open to the public. The copy center offers a variety of services, including black and white or color copies, term paper covers, resume printing, laminating, and various types of binding, among others. It is available for drop-off service. Please stop in or call 541-278-5966 to speak with a member of the copy center staff for more information.

Student Union Cafeteria

The Pendleton campus houses the BMCC Student Union and Cafeteria, located in Pioneer Hall. The cafeteria is operated by a local, privately run business. The cafeteria offers catering services to support the college faculty, staff, and students by assisting with special events and college catering. If you need any of these services, please call 541-278-5946.

The hours of operation are Monday through Thursday, 10:30 a.m. to 1:30 p.m. Payment methods include cash, check, or debit card. The cafeteria is closed on Fridays and holidays and during finals week, Christmas and spring breaks, and the summer. On Fridays, student clubs may sponsor special lunch events.

Library

The BMCC Library plays a vital role in the teaching and learning process. Through its various services, the library connects people, technology, and resource collections for student success in academics and in the pursuit of lifelong learning goals.

Located in Pioneer Hall on the Pendleton campus, the library provides a physical space for BMCC students, staff, and faculty and the general public to use a carefully selected collection of books, audio and video tapes, DVDs, periodicals, and newspapers. Individual carrels accommodate quiet study while mezzanine rooms provide for small group work and media listening/viewing sessions. Computer workstations and networked study carrels for laptops are available along with a copier, scanner, and printer.

The library's Web-based homepage, www.bluecc.edu/library, expands its collection and the availability of academic products and library services to students. Here, research is guided by links to subscription-based indexes and full-text databases, recommended Websites, request forms, study aids, and tutorials. The online public catalog provides rapid identification of media and print holdings at BMCC, other schools, and public and academic libraries in eastern Oregon. BMCC library cards, available to all students, allow access to additional services, including remote access to Web-based journal and newspaper databases, electronic reserves, and direct online requests for materials not in the BMCC library. The librarian and staff are available for reference assistance and course-related research instruction either in person or through "Ask a Librarian" feature on the Website.

Regardless of when and where you participate in courses, the library is available to teach you to retrieve and evaluate information in a society that places increasing importance upon these skills. For more information, call 541-278-5915.

Services for Students with Disabilities

BMCC is committed to providing equal access to all qualified students with disabilities. Providing academic adjustments and auxiliary aides and services to students with disabilities in order to remove barriers to physical spaces and program access is an important goal at BMCC. Faculty and staff members are informed, understanding, and supportive.

Students may qualify for services by providing appropriate documentation of their disability(-ies) at the time of the initial request. Accommodations will be arranged upon verification of provided documentation. Those requiring assistance with this process may work with the assistant director for advising, testing and disability services, located at the Pendleton campus but available to all students at any BMCC location. Once the student is qualified for services, the assistant director and the student will work together to determine which services will most benefit the student in a particular situation. All accommodations are arranged on an individual basis.

Each campus is equipped with a computer featuring some of the most popular assistive technology available.

Other available support services include: academic and career advising, special parking, and resource and referral information. Some accommodations take time to prepare and require advanced notice. For further information, contact the assistant director advising, testing and disability services at 541-278-5958.

Tutoring Program

It is our goal at BMCC to provide as many resources as possible to facilitate students' academic success. Part of being a successful student is taking advantage of the help available before you get to the point of feeling overwhelmed and/or are in danger of failing your courses. BMCC offers tutoring to help support students in their academic pursuit. BMCC strives to provide a wide range of tutor availability, meeting the needs of all of our students, whether they are on-site at one of our many locations or at a distance via online learning. We have drop-in tutoring available at most of our locations providing both peer and professional tutors, who are also trained to use Blackboard Collaborate and ITV. Blackboard Collaborate is an online program that can be accessed from the comfort of a student's home by scheduling a session with one of our on-site tutors and logging into the session at the time allotted. ITV is interactive television; this is offered through all of BMCC's campuses and requires that you be on a campus to access a tutor. BMCC has also purchased tutor.com, an online program that provides students 24/7 access to live tutors. Tutor.com provides assistance in math, science, english, social studies, and GED preparation. Students who have used tutor.com have rated it at 100% for help with homework and have stated that they would recommend this service to friends.

The tutoring program is provided at no cost to all BMCC students and is largely funded by our Associated Student Government (ASG) as a service to students. Students interested in getting tutoring can access a tutor schedule online at www.bluecc.edu/tutor or complete an online tutor request form.

Services and Programs

TRiO Student Support Services

TRiO/Student Support Services works with eligible, admitted students to provide comprehensive academic support. Nationwide, students who are part of a TRiO program tend to have higher GPAs and earn more credits than those who are not involved with TRiO. The TRiO program at BMCC offers a student computer lab, professional and peer tutoring, advising and four-year transfer assistance, workshops on study strategies and time management, book and calculator loans, and a place to meet other BMCC students.

To qualify, you must be a U.S. citizen or permanent resident and enrolled in a degree program at the Pendleton campus of Blue Mountain Community College. In addition, you must meet at least one of the following criteria: be a first-generation student (neither parent graduated with a bachelor's degree), have low income, or have a documented disability. For more information or to learn if you qualify, drop by the TRiO offices on the Pendleton campus in Morrow Hall, Room M141, or call 278-5853. TRiO information is available on-line at www.bluecc.edu.

Co-Curricular Activities

Athletics

BMCC participates in both the Northwest Athletic Association of Community Colleges (NWAACC) and the National Intercollegiate Rodeo Association (NIRA). The NWAACC is the parent organization for 36 community colleges in Oregon and Washington. BMCC sponsors athletic teams under the NWAACC, including women's volleyball, men's and women's basketball, women's softball, and men's baseball. The BMCC rodeo team competes in the NIRA Northwest Region with universities and colleges from Oregon, Washington, and Idaho. NWAACC and NIRA colleges provide a variety of academic and vocational offerings as well as many enrichment activities for their students.

Under the guidance of BMCC's coaches and athletic director, student athletes are part of an athletic program that:

- Stresses academic, personal, and athletic excellence
- Strengthens success-producing traits such as dedication, discipline, focus, integrity, communication, organization, and leadership
- Emphasizes the value of teamwork
- Creates a positive, lasting memory of BMCC for each athlete

BMCC has been active in the rodeo world almost since the college was founded. Our men's and women's rodeo teams compete in intercollegiate rodeos throughout the Northwest and nationally. The team has enjoyed great success over the years by winning numerous regional championships and by winning the national championship in 1987 and the national reserve championship in 1999. The BMCC rodeo team has produced many regional and national champions who have gone on to participate in the Professional Rodeo Cowboys Association (PRCA) and become world and national PRCA champions.

If you are interested in becoming part of the Timberwolves pride and spirit, please contact the BMCC Athletics Department or team coach.

BMCC Athletics Department	541-278-5900
Baseball	541-278-5900
Women's Softball	541-278-5895
Men's Basketball	541-278-5893
Women's Basketball	541-278-5894
Women's Volleyball	541-278-5910
Men's and Women's Rodeo	541-278-5930
Athletic Secretary	541-278-5896

Clubs

BMCC offers a variety of student activities that enhance the cultural atmosphere of the Pendleton campus and provide educational, recreational, social, and leadership opportunities for interested students. For more information contact the Associated Student Government (ASG) club coordinator in the ASG Office in Pioneer Hall on the Pendleton campus.

Housing

BMCC does not provide on-campus housing, nor do we recommend, endorse, or make claims of any type concerning private housing available in our district. We do, however, provide a listing on our Website of property management companies that have rentals available to students. In addition, local newspapers in the region list available housing.

Music

The Department of Music offers opportunities for students to participate in a variety of performing groups such as choir, vocal jazz ensemble, jazz band, and two local symphonies. Students may take guitar, piano, and voice lessons to develop musicianship and songwriting skills. For more information about this program, please call the music department at 541-278-5174.

Student Ambassadors

BMCC student ambassadors represent various regions, programs, and interests of the student body. They participate in recruitment events and college fairs, visit high schools, give campus tours, communicate with potential students, and represent BMCC to the community.

The student ambassadors' primary function is to provide leadership, assistance, and information to prospective BMCC students. The program is an exciting opportunity that helps students develop their leadership skills, while making lifelong friends. By becoming an ambassador, you can make a difference in a prospective student's outlook by giving him/her information about the transition into college life and how to make the most out of the college experience.

In exchange for weekly service, student ambassadors receive tuition waivers and leadership training. Each spring, the college selects ambassadors for the following academic year. For more information contact the Outreach Office at 541-278-5936.

Services and Programs

Student Government

BMCC has an active student government. The Associated Student Government (ASG) is responsible for planning various cultural, governmental, and entertainment events as well as contributing to college governance committees. The executive committee of the ASG consists of the president, vice president, secretary, treasurer, club coordinator, publicity director, and outreach liaison officer. The remaining members of the ASG are student senators. If you are interested in becoming an active member of ASG, please contact any ASG executive committee member, by email at asgbmcc@bluecc.edu, or the ASG advisor at 541-278-5154. All BMCC students are encouraged to become involved.

Theatre Arts

For over 40 years, the BMCC Theatre Arts Department has enjoyed a unique collaboration directing with College Community Theatre (CCT), the local community theatre company. Together, and often also working with the BMCC Music Department, these combined programs produce a minimum of three major productions each academic year, presented in the 275-seat Bob Clapp Theatre on the BMCC Pendleton campus. These productions provide creative opportunities and valuable hands-on experience for students and volunteers alike, while presenting first-rate theatre for the enjoyment of audiences from throughout the region. Whether merely seeking a creative outlet, or preparing for a career in the theatre arts, participants can work both on and off stage in all areas of theatrical production, including: acting, scenic, costume, and lighting design and construction, box office, stage management, assistant directing, and more. For more information contact the BMCC Fine Arts Department at 541-278-5944 or email theatre@bluecc.edu.

College Preparatory (CP) Programs

The College Preparatory Programs Department includes the following program areas: adult basic education (ABE), general educational development (GED) preparation, English as a second language (ESL), JOBS program, and college preparation courses. The department also offers the following transfer courses: HD100 College Survival and Success and HD109 Academic Planning. For more information about any of these programs call 541-278-5803 or visit us on the Web at www.bluecc.edu.

Adult Basic Education (ABE)

Adult Basic Education (ABE): Provides instruction in the basic skills of reading, writing, and math to adult learners to help them transition into the labor market, higher academics, or vocational training. ABE classes are available to students who have GED certificates or high school diplomas, but have been away from academics for an extended time. ABE programs operate at the following BMCC locations: Pendleton, Hermiston, Baker City, Milton-Freewater, Boardman, Enterprise, and John Day.

General Educational Development (GED)

General Educational Development classes are offered for students who are working on meeting GED requirements to complete the battery of five exams; reading, writing, math, social studies, and science. GED is the process of earning the equivalent of a high school diploma. Online GED Academy study site is offered as

an alternative to students who need to study at their own pace. Online GED Academy is an intuitive and interactive skills building tutorial. The site is designed to increase technology skills and help students study for the GED examines.

Students earn the GED certificate when they receive passing scores on the five parts of this standardized exam. A new computer-based GED test begins 2014. A high school release is required for students sixteen and seventeen years old. Information on testing and school release may be obtained from the BMCC testing center in Pendleton at 541-278-5931. Students earning a GED may participate in the BMCC commencement exercises held in June.

English as a Second Language (ESL)

ESL instruction is offered to non-English speaking students who need instruction in reading, writing and speaking. ESL courses are available at the following BMCC locations: Pendleton, Hermiston, Milton-Freewater, Boardman, and Baker City.

EL Civics

English Literacy through Civics: Civics education is an education program that emphasizes contextualized instruction on the rights and responsibilities of citizenship, naturalization procedures, civic participation, and US history and government to help students acquire the skills and knowledge to become active informed parents, workers, and community members.

College Preparation Courses

College preparation courses are courses designed to help students succeed in college.

Language Arts 25/35	4 cr	Reading, writing, spelling and vocabulary skills
HD 100	3 cr	College Survival and Success
HD 109	1 cr	Academic Planning
RD 090	3 cr	Effective Reading Strategies
RD 101	3 cr	College Textbook Reading

A student's COMPASS placement score determines whether and at which level the student should be placed into a college preparation course. Students can decide independently to take college preparation courses to improve their basic skills knowledge. Instructors may refer students whose academic performance indicates they would benefit from additional college preparation. In addition, students can be referred by their instructors based upon their performance in class. College preparation courses are offered at the following BMCC locations: Pendleton, Hermiston, Milton-Freewater, and Baker City.

College Preparatory Program offices are located in the lower level of Morrow Hall. Debbie Merrill, program assistant is located in M-4; telephone 541-278-5803; email: dmerrill@bluecc.edu.

Services and Programs

JOB Program

JOB for Oregon's Future (JOB: Job Opportunities and Basic Skills) is the state's employment and training program for people on public assistance. In addition, JOB can help low-income families avoid the need for welfare.

Through a contract with the Oregon Department of Human Services, BMCC provides JOB Program services in Umatilla County, including employment assessment, work-search assistance, and training in workplace basics and life skills. Clients receiving help through the Temporary Assistance for Needy Families Program may be eligible for JOB Plus services, which places persons in limited-duration training positions with private employers. As part of BMCC's Department of College Preparatory Programs, the JOB Program works closely with basic skills offerings as well as with other BMCC educational services in order to help JOB students meet their goals.

The JOB Program is located at BMCC Hermiston, BMCC Milton-Freewater, and the Oregon Employment Department in Pendleton. For more information, please call the JOB Program manager at 541-938-4082 x3172.

Other Programs

Community Education

BMCC is committed to lifelong learning and serves the needs of adult learners by providing a wide variety of innovative, high quality, community-driven, and affordable courses through our community education program with non-credit, short-term courses, workshops, lectures, and personal interest/hobby courses. For more information, contact your local BMCC location or call 541-278-5786 in Pendleton. You may also visit: <http://bluecc.edu/continuingeducation>, for a continuous list of classes and registration information.

Continuing Education

The continuing education program is part of the college's commitment to make educational services available throughout the college district by offering educational programs and opportunities designed to help adults of all ages reach their vocational objectives and realize their personal potential. A primary emphasis for the college is working with business and industries to provide a variety of training programs that can be delivered on-site or at one of the college's facilities. These programs can be tailored to meet the specific needs of business or industry clients, providing a timely, relatively inexpensive solution to their training needs. For more information on courses customized to your business or to schedule a special training, call your local BMCC center or 541-278-5786 in Pendleton. You may also e-mail: continuingeducation@bluecc.edu.

Academic Partnerships

BUSINESS PARTNERSHIPS

Apprenticeship: Apprenticeship training as a method of career and technical education is recognized by the Apprenticeship and Training Division of the Oregon Bureau of Labor and Industries (BOLI). It combines on-the-job training and trade-related

instruction taken in conjunction with each other. Apprenticeship courses are approved for BOLI-registered apprentices or journey-level workers and are not available to the general public.

BMCC's apprenticeship program offers associate of applied science degrees and certificates of completion for journeymen in the areas of inside electrician, manufacture plant electrical, limited maintenance electrical, plumbing, and programmable logic controller technician as part of Oregon's community college statewide apprenticeship degree program. The program provides statewide transfer opportunities, certificates of completion, and an optional transfer path into either a bachelor of applied in technology and management or a bachelor of science degree in operations management at the Oregon Institute of Technology. Electricians and plumbers require state licensure. Related training courses meet industry standards and are offered through a partnership between the Oregon State Apprenticeship Training Council and the local Joint Apprenticeship Training Committee.

If you are interested in becoming registered in an Oregon State Apprenticeship program, please contact the Oregon State Bureau of Labor and Industries Apprenticeship Training Division at 971-673-0761 or www.boli.state.or.us for program and entrance requirements. For more information on BMCC's apprenticeship certificates and degrees, see pages 72-75 of this catalog, or contact the apprenticeship coordinator at 541-278-5854.

Cooperative Work Experience (CWE): Students may earn college credit for cooperative work experience (CWE) related to their occupational goal. Such work experience must take place at work sites approved by the college and be monitored by the course instructor. The experience may be in business, industry, agriculture, or education, or with public service agencies that are willing to enter into work experience agreements with the college.

To find out more about the CWE program, check with the course instructor, your advisor, or contact the Office of Instruction.

Small Business Development Centers: BMCC serves business communities in our region through our Small Business Development Centers (SBDC). We are part of a network that includes 19 centers in Oregon and over 2,000 in the U.S. BMCC's SBDC is funded by the college, by the Small Business Administration (SBA), and by the Oregon Business Development Department.

Our premier service is free, confidential, one-on-one, business counseling by experienced business counselors for business owners and managers. Additional training programs and a variety of services are available, many on a reduced-cost basis, to SBDC clients. Visit our statewide SBDC Website www.bizcenter.org for an overview of programs or to register as a new client.

To take advantage of SBDC programs and services, you may not have to leave your home or office. Many are available online as workshops, webinars, or complete courses. You can meet with a business counselor using Internet video conferencing at locations

Services and Programs

throughout eastern Oregon. Visit www.ed2go.com/bmcc to view online courses. Call 1-888-441-7232 for more information about additional distance learning opportunities.

The programs and services of the BMCC Small Business Development Centers are available year-round to new or experienced business owners throughout eastern Oregon. Clients range from students planning their first business to owners and managers of companies with hundreds of employees. Information on programs and registration as an SBDC client is available toll-free at 1-888-441-7232 or by email at sbdc@bluecc.edu.

HIGH SCHOOL PARTNERSHIPS

Dual-Credit Program: In cooperation with many high schools and the local education service district (ESD), BMCC offers a state-approved dual-credit program. Students at a public high school that has an articulation agreement with BMCC may meet the educational requirements of both the high school and a college-level BMCC course if they are enrolled for dual credit in a class taught at the high school. This challenging course work offers students the opportunity to begin building a college transcript while still enrolled in high school. Dual-credit courses and credits appear on a BMCC transcript as though they were taken at BMCC. Dual-credit courses normally transfer to four-year institutions in the same way as any other BMCC course work. Not all courses are available at every high school. High school students may check with their high school counselors and teachers for course availability, costs, and other requirements, or they may check with the ESD for further information. Students should also check with the college to which they wish to transfer if they want to ensure that dual-credit course work will transfer.

Expanded Options: BMCC offers a dual-enrollment program in conformance with Oregon's Expanded Options legislation (also known as SB300 and SB23). This program offers high school students the ability to take BMCC classes to earn college credit and to earn credit toward high school graduation at the same time. Each high school sets its own criteria for entry into the program and monitors student progress. College-level credits earned are transcribed through BMCC and are, in most cases, transferable to other colleges.

Though similar, dual-credit and expanded options programs have distinct differences:

- Students participating in the dual-credit program take classes at their high school from high school instructors and earn college credit at the same time
- Students participating in the expanded options program take a college course from college instructors with other college students and earn high school credit at the same time; the high school pays all of the cost of the college course.

If you are interested in one or both of these opportunities, contact your high school or ESD; or contact the Registrar's Office at BMCC.

INTER-COLLEGE PARTNERSHIPS

Eastern Oregon Collaborative Colleges Council (EOCCC):

BMCC, Treasure Valley Community College (TVCC), and Eastern Oregon University (EOU) have worked together in several academic disciplines to improve articulation opportunities for students, allowing them to share lower division course work among BMCC, TVCC, and EOU; to transfer those credits to EOU; and to complete upper division courses at EOU culminating in a four-year degree. For more information on the co-enrollment process, please go to the Service Center or call 541-278-5759.

Oregon State University Dual Admission: Through an agreement with Oregon State University (OSU), BMCC students may be jointly admitted to BMCC and OSU and be eligible to enroll concurrently at both institutions. There is a joint application process for eligible students; the admission deadline is one week before the start of classes of each term based on OSU's academic calendar. Students enrolled in the program are required, as a condition of admission, to agree that their student records will be shared between and available to each institution. For more information on this program, contact BMCC's Office of Admissions and Records.

ARTICULATED DEGREE PROGRAMS

BMCC enjoys articulation agreements with a variety of institutions. The following agreements allow you to attain your degree while staying in your local area.

CUESTE: Teacher Education Program: CUESTE (pronounced "quest") stands for Curriculum of Undergraduate Elementary School Teacher Education and is a collaborative program between BMCC and Eastern Oregon University (EOU).

Students seeking elementary teacher licensure need to complete a major in multidisciplinary studies; a minor in an academic area, endorsement area, or course of study; and a minor in elementary education. When students are within 100 credit hours of finishing the CUESTE program requirements, they may apply to EOU's CUESTE program. The completion of CUESTE program requirements leads to a bachelor's degree (science or art) in multidisciplinary studies, a minor in elementary education, and certification in primary (age 4 through grade 4) and elementary (3-8) grades. Through the CUESTE program, BMCC offers the first two years, and an A.A.O.T. degree, and EOU provides the last two years of the elementary education degree at BMCC's Pendleton campus.

Two full-time EOU education professors are in residence at BMCC's Pendleton campus to advise students, teach classes, and coordinate EOU and BMCC processes. (Please note: Much of the major course work for secondary teaching certification may be acquired through distance education courses available from EOU and BMCC. However, the secondary education component needs to be completed on EOU's campus in LaGrande.)

Services and Programs

Diagnostic Imaging (Radiologic Technology) Program: BMCC has partnered with Linn-Benton Community College to offer a distance education program for diagnostic imaging. Using a combination of clinical instruction, online courses within the college learning management system, and the synchronous virtual classroom environment, distance education students can receive dynamic instruction to help them achieve their learning goals.

The Diagnostic Imaging Program prepares students through a progressive, outcome-based educational format. Modules of study include radiation protection, radiographic procedures, image production and evaluation, equipment maintenance operation, patient care and management, and clinical radiography.

The purpose of this program is to prepare students to practice as proficient, multi-skilled professionals in culturally diverse health care settings; to demonstrate outcomes required by the American Registry of Radiological Technologists (ARRT) and The American Society of Radiological Technologists (ASRT) Course Curriculum Guide; and to apply for and successfully complete ARRT certification examinations. Upon completion of the program and the general education requirements students will be eligible to apply for an associate of applied science degree through Linn-Benton Community College.

The Diagnostic Imaging Program is highly prescriptive and entails several key elements; please contact our program site coordinator, Crystal Patton-Doherty, at 541-278-5876 for more information about this program.

Occupational Therapy Assistant Program: BMCC has partnered with Linn-Benton Community College to offer a two-year associate's degree program designed to prepare the student to function as an entry-level occupational therapy assistant (OTA).

OTAs work under the supervision of occupational therapists to help clients develop, maintain, and/or regain health and function through the use of purposeful activity. They address physical, mental, and social components of activity as they work with clients to improve the underlying cause of impairment and/or to adapt activities for client success. This program follows a hybrid-delivery model in which the classroom portion is delivered online (to allow participation by students at remote sites) and the laboratory and clinical portions are delivered locally and at partner sites throughout Oregon. Graduates will be eligible and prepared to sit for the national certification examination.

Please contact our program site coordinator, Crystal Patton-Doherty, at 541-278-5876 for more information about this program.

Pharmacy Technician Program: BMCC has partnered with Central Oregon Community College to offer this three-term program developed to prepare individuals for employment in the pharmacy industry. Pharmacy technicians are skilled workers who are educated and trained to work in a pharmacy and assist in all

areas of the pharmacy not requiring the professional judgment of the registered pharmacist. Some current practice areas for the pharmacy technician include retail, hospital, manufacturing, disease state management, and mail order and insurance claim specialists. The pharmacy technician processes prescriptions and medication orders and plays an integral role in maintaining the pharmacy department.

Courses are completed in an online and hybrid format. They focus on the abilities needed to assist the pharmacist and provide the skills necessary to process prescriptions accurately, participate in administration and management of a pharmacy, and maintain inventory. Topics of study include medical terminology, anatomy and functions of the human body, therapeutic classification and drug names, pharmacy procedures, pharmaceutical calculations, pharmacy law and interpersonal communications. Students will have a working knowledge of sterile technique, standards of practice, quality assurance and patient confidentiality. In addition, students will develop and practice communication skills needed to function in a professional setting. In order to gain workplace experience, students will also participate in a hospital and retail pharmacy practicum.

The program will prepare students to take the national certification examination to become a certified pharmacy technician as required by the Oregon Board of Pharmacy and to be employed in a pharmacy setting.





Please contact our program site coordinator, Crystal Patton-Doherty, at 541-278-5876 for more information about this program.

Medical Lab Technician Program: BMCC has partnered with Wenatchee Valley College to offer this two-year degree to provide students with the general knowledge and basic skills needed for this allied health profession.

During the preparatory first three quarters of the first year, the typical MLT student takes general education courses and specialized medical laboratory courses designed to provide a solid base for the second year of on-the-job training. Students spend the second year in medical laboratory facilities that have agreed to be training centers, while simultaneously taking theoretical supporting courses.

Please contact our program site coordinator, Crystal Patton-Doherty, at 541-278-5876 for more information about this program.

Career Pathways

Pathways	What are your interests?
	<ul style="list-style-type: none"> • Are you a creative thinker? Are you imaginative, innovative, and original? • Do you like to communicate ideas? • Do you like making crafts, drawing, playing a musical instrument, taking photos, or writing stories?
	<ul style="list-style-type: none"> • Do you enjoy being a leader, organizing people, planning activities, and talking? • Do you like to work with numbers or ideas? • Do you enjoy carrying through with an idea and seeing the end product? • Do you like things neat and orderly? • Would you enjoy balancing a checkbook, following the stock market, holding an office in a club, or surfing the Internet?
	<ul style="list-style-type: none"> • Do you enjoy preparing food? • Are you practical, curious about the physical world, and interested in plants and animals? • Do you enjoy hunting or fishing? • Do you like to garden or mow the lawn? • Are you interested in protecting the environment?
	<ul style="list-style-type: none"> • Do you like to care for people or animals who are sick or help them stay well? • Are you interested in diseases and in how the body works? • Do you enjoy reading about science and medicine? • Would it be fun to learn first aid or volunteer at a hospital or veterinary clinic?
	<ul style="list-style-type: none"> • Are you friendly, open, understanding, and cooperative? • Do you like to work with people to solve problems? • Do you enjoy explaining something you have learned? • Is it important to you to do something that makes things better for other people? • Do you like to help friends with family problems? • Do you like reading, storytelling, traveling, or tutoring young children?
	<ul style="list-style-type: none"> • Are you mechanically inclined and practical? • Do you like reading diagrams and blueprints, and drawing building structures? • Are you curious about how things work? • Would you enjoy painting a house, repairing cars, wiring electrical circuits, or woodworking?

Degree Index-*Alphabetical list*

A.A.O.T. _____	42
A.A.S. General Requirements _____	46
A.G.S. (Associate of General Studies) Transfer Degree _____	45
A.S. Associate of Science Transfer Degree _____	43
Accounting Technology A.A.S. _____	51
Accounting: Bookkeeping Support Specialist C.P.C.C. _____	50
Accounting Technician Certificate _____	50
Administrative Office Professional A.A.S. _____	52
Administrative Office Professional: Office Support Specialist C.P.C.C. _____	51
Administrative Office Professional - Legal Option A.A.S. _____	53
Administrative Office Professional - Medical Option A.A.S. _____	53
Agriculture Business A.A.S. _____	48
Agriculture Production A.A.S. _____	48
Agriculture Production: Crops Option A.A.S. _____	49
Agriculture Production: Crops: Pest Management C.P.C.C. _____	47
Agriculture Production: Livestock Option A.A.S. _____	49
Agriculture Production: Livestock: Beef Production C.P.C.C. _____	47
Business Administration A.A.S. _____	54
Business Administration: Business Operations Support Specialist C.P.C.C. _____	54
Business Administration - Hospitality and Gaming Option A.A.S. _____	56
Civil Engineering Technology A.A.S. _____	69
Construction Trades, General Apprenticeship A.A.S. _____	72
Construction Trades, General Apprenticeship-Construction Trades General Apprenticeship S.C.P.C. _____	72
Construction Trades, General Apprenticeship-Trade Worker Apprenticeship Technologies S.C.P.C. _____	72
Criminal Justice A.A.S. _____	65
Criminal Justice: Corrections C.P.C.C. _____	64
Criminal Justice: Court Technician C.P.C.C. _____	64
Criminal Justice: Law Enforcement C.P.C.C. _____	65
Dental Assisting Technician Certificate _____	60
Diesel Technology A.A.S. _____	70
Diesel Technology: Technician Assistant C.P.C.C. _____	69
Drafting Technology A.A.S. _____	71
Drafting Technology: Survey Technician C.P.C.C. _____	70
Early Childhood Education A.A.S. _____	66
Early Childhood Education (one-year) Certificate _____	66
Early Childhood Education Assistant C.P.C.C. _____	66
Electrical Apprenticeship Technologies-Limited Electrician Technologies Certificate S.C.C. _____	73
Electrician Apprenticeship Technologies A.A.S. _____	74
Electrician Apprenticeship Technologies-Trade Worker Apprenticeship Technologies S.C.P.C. _____	73
Electrician Apprenticeship Technologies-Electrician Apprenticeship Technologies Certificate S.C.C. _____	73
Emergency Medical Technician (EMT) Certificate _____	61
English Language Development (ELD) Certificate (less than one year) _____	67
Green Technician Certificate _____	71
Hospitality Management A.A.S. _____	57
Hospitality, Tourism and Management Certificate _____	55
Industrial Mechanics and Maintenance Technology Apprenticeship A.A.S. _____	75
Industrial Mechanics and Maintenance Technology Apprenticeship-Industrial Mechanics and Maintenance Technology Apprenticeship Certificate S.C.C.1. _____	75
Industrial Mechanics and Maintenance Technology Apprenticeship-Mechanical Maintenance Apprenticeship Certificate S.C.C. _____	74
Industrial Mechanics and Maintenance Technology Apprenticeship-Trade Worker Apprenticeship Tech S.C.P.C. _____	74
Nursing A.A.S. _____	63
Office Assistant Certificate _____	58
Office Assistant - Medical Option Certificate _____	58
O.T.M. Oregon Transfer Module _____	44
Paraeducator A.A.S. _____	68
Paraeducator Certificate _____	68
Paraeducator: Autism Certificate _____	67
Paraeducator: Elementary Educator C.P.C.C. _____	67
Professional Truck Driver (less than one year) _____	71
Retail Management Certificate _____	59
Retail Management Certificate (less than one year) _____	59
Welding Certificate (less than one year) _____	70

Degrees and Certificates

BMCC reviews and updates degree requirements annually. Please note that some of the requirements for graduation may change if your studies are interrupted by one or more years or if you take more than five years to complete a course of study. Depending upon the academic program, you may be asked to complete updated requirements in order to earn a certificate or degree.

Statement of Student Outcomes

Through the course offerings necessary to attain a degree, BMCC students will have achieved the following core competency skills:

- Written and oral communication
- Critical thinking and problem solving
- Community, cultural, and diversity awareness
- Information and technology literacy
- Workplace, wellness, and ethical responsibility

To ensure the educational breadth necessary to acquire these core competencies, degree candidates must complete work in general education and other specific requirements related to each degree.

COMPUTER LITERACY REQUIREMENT

Computer literacy is a graduation requirement for all one-year certificate and two-year degree programs. The computer literacy component allows you some options. If you take the computer literacy placement assessment and score an average of 75% or higher, the college will waive your computer literacy course requirement for graduation. If you score an average of 85% or higher, you may receive credit for CS120 under the credit by examination (CBE) process. To receive credit, you must complete the CBE form and pay related tuition. If you average below 75%, a computer literacy course will become a requirement for graduation; should that occur, the college strongly recommends that you take the computer literacy course early in your coursework to ensure your success.

Transfer Options

ASSOCIATE OF ARTS OREGON TRANSFER (A.A.O.T.) degree, a non-designated block transfer degree designed for the student who intends to transfer to a four-year college or university within the Oregon University System (OUS). Students need to work closely with an academic advisor to plan a course of study at BMCC.

ASSOCIATE OF SCIENCE (A.S.) degree, a non-designated college transfer degree designed for students whose program requirements do not fit A.A.O.T. degree patterns. This degree does not always “block transfer” to Oregon colleges.

OREGON TRANSFER MODULE (O.T.M.), a one-year module designed to complete a portion of students’ general education requirements and is transferable to any OUS institution. Upon transfer of credits, the receiving institution may specify additional course work that is required for a major or degree requirements or to make up the difference between the O.T.M. and the institution’s total general education requirements.

This module is an excellent choice for the student who is planning to transfer to a four-year institution and either is undecided on a major or will be majoring in a program of study with specific lower division requirements that are not offered at BMCC. With the one-year module, a student can complete most general education requirements and then transfer to the four-year institution, where he or she can complete the remaining lower division requirements.

Transfer courses offered at BMCC parallel freshman and sophomore courses offered by four-year colleges and universities. If you are planning to seek a degree at a specific four-year college or university, you should become familiar with the requirements of the proposed major program at that institution. BMCC advisors are available to assist you in this planning process.

In addition to the requirements of a major, OUS institutions require that the student earn credit hours in each of the major academic divisions: arts and letters (language, literature, and the arts), the social sciences, sciences and mathematics, and writing. These are typically referred to as general education requirements, or general university requirements. Students at BMCC who complete the A.A.O.T. as outlined will meet these OUS lower division general education requirements. Specific departmental requirements at OUS institutions can be found in the catalog of the college or university to which the student intends to transfer. OUS institutions generally will accept up to 120 credit hours of lower division course work from Oregon’s community colleges.

Degree and Certificate Options

ASSOCIATE OF GENERAL STUDIES DEGREE (A.G.S.), a non-designated non-transfer two-year degree that consists of both career and technical education (CTE) courses and college-transfer courses.

ASSOCIATE OF APPLIED SCIENCE DEGREE (A.A.S.), awarded to students who complete the requirements of a two-year designated program as outlined in the college catalog.

These degrees are two-year designated career and technical programs requiring a minimum of 90 credits. Each degree listed on the following pages includes program requirements and foundational requirements designed to meet core competencies that meet state requirements for writing, speech, mathematics/computer science, human relations, and general education.

CERTIFICATE OF COMPLETION, awarded to students who complete the requirements of a specific curriculum of less than two academic years.

The certificate of completion must include at least 9 credit hours of foundational requirement courses in the areas of communication, computation, and human relations. For specific program requirements, see the Program Description section of this catalog. Program requirements are subject to change. Please consult with an advisor for the most up-to-date information.

Degrees and Certificates

CAREER PATHWAYS CERTIFICATE OF COMPLETION (CPC), a less-than-one-year certificate in which all courses are contained within an existing A.A.S. or certificate program. The career pathway certificate provides a credential to acknowledge skill proficiency tied to a specific occupation, allowing the student to select that occupation or apply all coursework to an associated certificate or A.A.S. degree.



Degree Checklists

2012-2013 Associate of Arts Oregon Transfer (A.A.O.T.)

This is a tool used for planning purposes only. Students should review their degree audit online, by accessing their Student WolfWeb account. Be sure to communicate with your academic advisor and consult the Academic Catalog for official information concerning degree requirements, general rules and regulations.

General Degree Requirements	
<ol style="list-style-type: none"> 1. Total Credits Required: 90 2. Grade Requirement: All courses must be completed with a grade of "C" or better 3. Minimum number of BMCC credits: 24 4. Minimum number of BMCC credits applied toward degree: 18 5. Maximum number of credits earned as *credit for prior learning: 22 6. Maximum number of (P) graded program or elective credits: 12 7. Maximum number of **career-technical credits: 12 8. Cultural Literacy Requirement (~): 1 course. See list at bottom of page. 9. Computer Literacy requirement: <ol style="list-style-type: none"> a. IC3 Exam: score an average of 75% or higher on IC3 exams <p style="text-align: center;">OR</p> <ol style="list-style-type: none"> b. Course: AGR111, CS120, BA131, or ED235. Must pass course with a "C" or better 	
Foundational Requirements	
Requirements	Courses that satisfy requirements
Communication: 1 course	COM111
Health/Wellness: 3 credits	HE115, 250,252,253, HPE295, PE131,185,290,291,292,293
Mathematics: 1 course	MTH105 or higher
Writing: see sequence listed in next column	4 credit courses: WR121 and WR122 or WR227 OR 3 credit courses: WR121, WR122, and WR123 or WR227
Discipline Studies	
Requirements	Courses that satisfy requirements
Arts and Letters: Three(3) courses from two(2) or more disciplines	ART101-103,115-117,131-133,154-156,184-186,204-205,231-233, 254-256, 261-266, 276-278, 281-286, 291-293, COM112,115, ENG104-106, 107-109, 197, 201-206, 253- 255, 260,263-264,269, MUS205-207, PHL101-102, SPAN201-203, TA101-143,241-243, WR227, 241-243
Social Science: Four(4) courses from two(2) or more disciplines	ANTH101-103, EC201- 202, GEOG103, 120, 206, HST201-203, PS201-203, PSY201-202, 237, SOC204-205, 213, 217
Science w/Lab: Three(3) courses	BI101-103, 124, 162-163, 211-213, 231-234, BOT221, CH104-106, 221, CH110(as of 12-13), 221-223, G101-103, 201-203, GS104-105, 107, 110-111, 142, PHY101, 201-203, 211-213
Science/Math/Computer Science: 1 course <i>If "Science w/Lab" courses are all from one discipline (i.e.: BI, CH, G, GS or PHY) then coursework in this area must be from a different discipline</i>	BI101-103, 124, 149, 162-163, 211-213, 231-234, BOT221, CH104-106, 110, 221-223, CS120, 133B, 133U,161-162, 195, 260, 295, G101-103, 145-147, 201-203, GEOG101, GS104-105, 107, 110-111, 142, MTH105-261, PHY101, 201-203, 211-213
Electives: Select from General Elective and/or Career Technical Course list below	
General Elective Courses: Any 100 or higher level college course not designated as career-technical	
**Career-Technical Courses (max 12 credits): AGM131- 299, AGR101-299, ANS122-220, 222, 232-299, APR110A-217T, BA104-116, 155-190, 207- 210, 220-222, 224-225, 238-277, 284, 295, BT116-290, CET111-299, CJ210-240, 205, 210-212,225, 232-280, CSS100-240, DA141- 196, DSL141-280, ECE100-298, ED114-198, 235-252, 255, 260-268, 285-298, EMT115-177, FN230, GT101-115, HE100-198, 298, HORT100 -298, HTM100-232, NRS110-233, PHC211-212, RNG241, SUR161-167, TTL101-280, WLD111-256	
* Note: Credit for Prior Learning include: <ul style="list-style-type: none"> ✓ AP: Advanced Placement ✓ CL: College Level Examination Program (CLEP) ✓ CPL: Credit for Prior Experiential Learning ✓ CH: Challenge (Credit by Exam) ✓ MIL: Military credit 	
~ Cultural Literacy Course options: ANTH103, COM115, 237, ENG107-109,253, 260, GEOG103, 120, HST201-203, SOC204-205, 213,217	

Degree Checklists

2012-2013 Associate of Science (A.S.)

This is a tool used for planning purposes only. Students should review their degree audit online, by accessing their Student WolfWeb account. Be sure to communicate with your academic advisor and consult the Academic Catalog for official information concerning degree requirements, general rules and regulations.

General Degree Requirements	
1. Total Credits Required: 90 2. Minimum cumulative grade point average: 2.0 3. Computer Literacy requirement: a. IC3 Exam: score an average of 75% or higher on IC3 exams OR b. Course: AGR111, CS120, BA131, or ED235. Must pass course with a "C" or better 4. Minimum number of BMCC credits: 24 5. Minimum number of BMCC credits applied toward degree: 18 6. Maximum number of credits earned as *credit for prior learning: 22 7. Maximum number of (P) graded program or elective credits: 12 8. Maximum of physical education activity (PE185) credits: 12 9. Maximum number of **career-technical credits: 12	
Foundational Requirements: All courses must be completed with grade of "C" or better, may include a grade of "P" if earned as AP credit	
Requirements	Courses that satisfy requirements
Communication: 1 course	COM111
Computer Science: 1 course	CS120 or higher
Health/Fitness: 3 credits	HE115, 250,252,253, HPE295, PE131,185,290,291,292,293
Mathematics: 1 course	MTH105 or higher
Writing: 2 courses	WR121, WR122
Discipline Studies	
Requirements	Courses that satisfy requirements
Arts and Letters: 12 credits	ART101-103, 115-117, 131-133, 154-156, 184-186, 204, 205, 231-233, 254-256, 261-266, 276-278, 281-286, 291-293, COM112,115, ENG104-109, 197, 201-206, 253-255, 260,263, 264,269, MUS205-207, PHL101, 102, SPAN201-203, TA101,141-143,241-243, WR227,241-243
Social Science: 12 credits	ANTH101-103, EC201, 202, GEOG103, 120, 206, HST201-203, PS201-203, PSY201, 202, 237, SOC204, 205, 213, 217
Science w/Lab: 1 course	BI101-103, 124, 162, 163, 211-213, 231-234, BOT221, CH104-106, 221-223, G101-103, 201-203, GS104, 105, 107, 110, 111, 142, PHY101, 201-203, 211-213
Science/Math/Computer Science: 1 course	BI101-103, 124, 149, 162, 163, 211-213, 231-234, BOT221, CH104-106, 110, 221-223, CS120, 133B, 133U,161, 162, 195, 260, 295, G101-103, 145-147, 201-203, GEOG101, GS104, 105, 107, 110, 111, 142, MTH105, 111, 112, 211-213, 231, 241, 243, 251-254, 256, 261, PHY101, 201-203, 211-213
Electives: Select from General Elective and/or Career Technical Course list below	
General Elective Courses: Any 100 or higher level college course not designated as career-technical	
**Career-Technical Courses: (max 12 credits) AGM131- 299, AGR101-299, ANS122-220, 222, 232-299, APR110A-217T, BA104-116, 155-190, 207- 210, 220-222, 224-225, 238-277, 284, 295, BT116-290, CET111-299, CJ210-240, 205, 210-212,225, 232-280, CSS100-240, DA141- 196, DSL141-280, ECE100-298, ED114-198, 235-252, 255, 260-268, 285-298, EMT115-177, FN230, GT101-115, HE100-198, 298, HORT100 -298, HTM100-232, NRS110-233, PHC211-212, RNG241, SUR161-167, TTL101-280, WLD111-256	
* Note: Credit for Prior Learning include: ✓ AP: Advanced Placement ✓ CL: College Level Examination Program (CLEP) ✓ CPL: Credit for Prior Experiential Learning ✓ CH: Challenge (Credit by Exam) ✓ MIL: Military credit	

Degree Checklists

2012-2013 Oregon Transfer Module (O.T.M.)

This checklist is a tool that should be used for planning purposes only. Students should review their degree audit online, by accessing their Student WolfWeb account. Be sure to communicate with your academic advisor and consult the Academic Catalog for official information concerning degree requirements, general rules and regulations.

General Module Requirements:	
1. Total Credits Required: 45	
2. Grade Requirement: All courses must be completed with a grade of "C" or better	
3. Minimum number of BMCC credits: 12	
4. Minimum number of BMCC credits applied toward degree: 9	
Foundational Requirements	
Requirements	Courses that satisfy requirements
Communication	COM111
Mathematics	MTH105 or higher
Writing 2 courses	WR121, AND WR122 or WR227
Discipline Studies	
Requirements	Courses that satisfy requirements
Arts and Letters: 3 courses	ART101-103,115-117,131-133,154-156,184-186,204-205,231-233, 254-256, 261-266, 276-278, 281-286, 291-293, COM112,115, ENG104-106, 107-109, 197, 201-206, 253-255, 260,263-264,269, MUS205-207, PHL101-102, SPAN201-203, TA101-143,241-243, WR227, 241-243
Social Science: 3 courses	ANTH101-103, EC201- 202, GEOG103, 120, 206, HST201-203, PS201-203, PSY201-202, 237, SOC204-205, 213, 217
Science w/Lab: 1 course	BI101-103, 124, 162-163, 211-213, 231-234, BOT221, CH104-106, 221, CH110(as of 12-13), 221-223, G101-103, 201-203, GS104-105, 107, 110-111, 142, PHY101, 201-203, 211-213
Science/Math/Computer Science 2 courses	BI101-103, 124, 149, 162-163, 211-213, 231-234, BOT221, CH104-106, 110, 221-223, CS120, 133B, 133U,161-162, 195, 260, 295, G101-103, 145-147, 201-203, GEOG101, GS104-105, 107, 110-111, 142, MTH105-261, PHY101, 201-203, 211-213

Note: This is a module only and is not a degree or certificate but can be selected as a goal, and completion of module is noted on the transcript of students who select this goal.

Degree Checklists

2012-2013 Associate of General Studies (A.G.S.)

This is a tool used for planning purposes only. Students should review their degree audit online, by accessing their Student WolfWeb account. Be sure to communicate with your academic advisor and consult the Academic Catalog for official information concerning degree requirements, general rules and regulations.

General Degree Requirements:	
1. Total Credits Required: 90 2. Computer Literacy requirement: a. <i>IC3 Exam:</i> score an average of 75% or higher on IC3 exams OR b. <i>Course:</i> AGR111, CS120, BA131, or ED235. Must pass course with a "C" or better 3. Minimum number of BMCC credits: 24 4. Minimum number of BMCC credits applied toward degree: 18 5. Maximum number of credits earned as *credit for prior learning: 22 6. Grade Requirement: All courses must be completed with a grade of "C" or better	
Foundational Requirements:	
Requirements	Courses that satisfy requirements
Arts and Letters: 2 courses	ART 101-103, 115-117, 131-133, 154-156, 184-186, 204,205,231-233,254-256, 261-266, 276-278, 281-286, 291,292,293, COM 111,112, 115, ENG 104-109, 197, 201-206, 253-255, 260,263, 264,269, MUS 205-207, PHL 101, 102, SPAN 201-203, TA 101, 141-143, 241-243, WR 121,122, 227, 241-243
Communication: 1 course	COM 100 or COM 111
Mathematics: 1 course Course must be 3 credits or higher	MTH 042 or MTH 070 or higher, or BA 104, or ED 157
Science with Lab/ Computer Science: 1 course	BI 101-103, 124, 162, 163, 211-213, 231-234, BOT 221, CH 110 (if taken with lab component), CH 221-223, CS 120, 121, 122, G 101-103, 201-203, GS 104, 105, 107, 110, 111, 142, PHY 101, 201-203, 211-213
Social Science: 2 courses	ANTH 101-103, EC 201, 202, GEOG 103, 120, 206, HST 201-203, PS 201-203, PSY 201, 202, 237, SOC 204, 205, 213, 217
Writing: 1 course	WR 121 or higher
Electives:	Any 100 or higher level college course.
* Note: Credit for Prior Learning include: ✓ AP: Advanced Placement ✓ CL: College Level Examination Program (CLEP) ✓ CPL: Credit for Prior Experiential Learning ✓ CH: Challenge (Credit by Exam) ✓ MIL: Military credit	

Degree Checklists

2012-2013 Associate of Applied Science (A.A.S.)

This is a tool used for planning purposes only. Students should review the specific course requirements for the A.A.S. degree they are seeking by checking the online degree audit system. This system can be accessed through the Student WolfWeb. Be sure to communicate with your academic advisor and consult the Academic Catalog for official information concerning degree requirements, general rules and regulations.

General A.A.S. Requirements	
1. Minimum Credits Required: 90 2. Minimum cumulative grade point average: 2.0 a. Note: Some A.A.S. degree programs require a grade of "C" or better in some or all coursework 3. Computer Literacy requirement: a. IC3 Exam: score an average of 75% or higher on IC3 exams OR b. Course: AGR111, CS120, BA131, or ED235. Must pass course with a "C" or better 4. Minimum number of BMCC credits: 24 5. Minimum number of BMCC credits applied toward degree: 18 6. Maximum number of credits earned as *credit for prior learning: 22 a. Note: Amount may vary based on total credits required for specific A.A.S. degree program 7. Maximum number of (P) graded program or elective credits: 12	
Foundational Requirements:	
Requirements	Courses that satisfy requirements
Communication:	COM100-115
Computation:	MTH025 or higher, or BA104-105, 131, or CS120 or above
Human Relations:	ANTH101-103, ART101-103, 115-117, 131-133, 154-156, 184-186, 204, 205, 231-233, 254-256, 261-266, 276-278, 281-286, 291-293, BA277, 285, EC201, 202, ENG104-109, 197, 201-206, 253-255, 260, 263, 264, 269, GEOG103, 120, 206, HST201-203, MUS205-207, PHL101, 102, PS201-203, PSY201, 202, 237, RD120, SOC204, 205, 213, 217, SPAN201-203, TA101, 141-143, 241-243, WR121, 122, 227, 241-243
Writing: 2 courses	WR060-227 or BA214
* Note: Credit for Prior Learning includes: ✓ AP: Advanced Placement ✓ CL: College Level Examination Program (CLEP) ✓ CPL: Credit for Prior Experiential Learning ✓ CH: Challenge (Credit by Exam) ✓ MIL: Military credit	

Degree and Certificate Detail Listing

FOOD AND NATURAL RESOURCES PATHWAY

Agriculture Production-Crops: Pest Management Career Pathway Certificate of Completion (CPCC)



Agriculture, Food, and Natural Resources Systems

Intended Program Outcomes:

This less than one-year certificate program in agriculture production-crops: pest management will prepare the student for all aspects of pest management including the proper handling and application of related materials by providing the necessary knowledge in the following areas:

- Industry-related employment skills
- Crop science (techniques, issues, technology, trends)
- Agriculture-related business practices
- Agricultural operations (safety, mechanical technology)

HORT100 Plant Science	3
CSS240 Pest Management	4
RNG241 Range Management	3
AGM221 Metals and Welding	3
AGR200 Pre-Employment Seminar	1
AGR111 Agriculture Computers	3
AGR101 Agriculture Orientation	1
AGM241 Agriculture Machinery	3
AGM251 Irrigation Systems	3
AGM131 Agriculture Safety	3
AGR226 Agriculture Issues	3
CSS100 Soils and Fertilizers	3
CSS201 Principles of Crop Science	3
AGR280 CWE AG	3
MTH070 Elementary Algebra (or higher)	5

TOTAL CREDITS: 44

Agriculture Production-Livestock: Beef Production Career Pathway Certificate of Completion (CPCC)



Agriculture, Food, and Natural Resources Systems

Intended Program Outcomes:

This less than one-year certificate program in agriculture/production-livestock: beef production will prepare the student for all aspects of beef production by providing the necessary knowledge in the following areas:

- Industry-related employment skills
- Animal science (techniques, issues, technology, trends)
- Agriculture-related business practices
- Agricultural operations (safety, mechanical technology)

CSS210 Forage Crops	3
RNG241 Range Management	3
ANS121 Animal Science	3
ANS217 Artificial Insemination	3
ANS122 Animal Science	3
ANS211 Animal Nutrition	4
AGR111 Agriculture Computers	3
AGR101 Agriculture Orientation	1
ANS231 Livestock Evaluation	3
ANS220 Beef Production	4
ANS240 Animal Health	5
ANS216 Pregnancy Testing/Bovine	1
AGR280 CWE AG	5

TOTAL CREDITS: 41

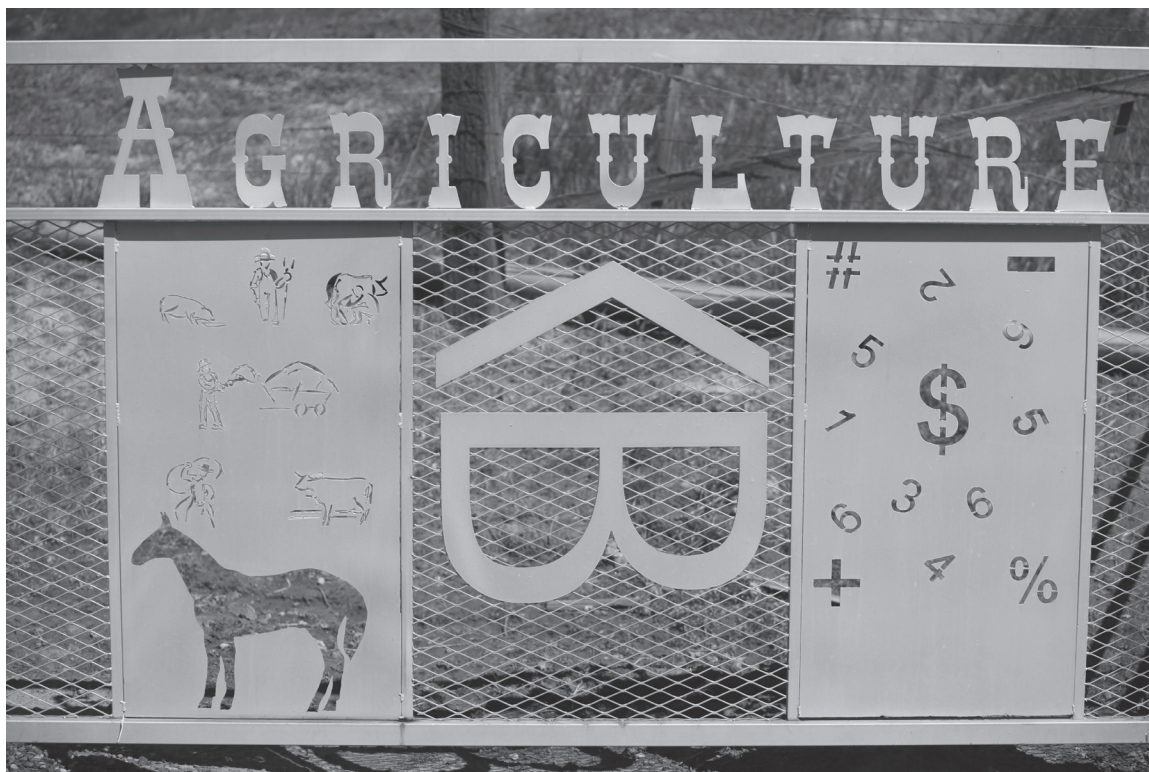

FOOD AND NATURAL RESOURCES PATHWAY

A.A.S./Agriculture Business



Business and Management



Agriculture, Food and Natural Resources Systems

Intended Program Outcomes:

This two-year program leading to an A.A.S. in agriculture business will prepare the student for a career in the broad field of agri-business or in support areas of production agriculture by providing the necessary knowledge in the following areas:

- Industry-related employment skills
- Animal science (techniques, issues, technology, trends)
- Crop science (techniques, issues, technology, trends)
- Agriculture-related business practices
- Agricultural operations (safety, mechanical technology)

Opportunities are available in sales of equipment, fertilizer and chemicals, agricultural credit, record-keeping and other areas. Many of the business and agriculture courses may be transferred to other four-year colleges. Students wishing to transfer to a four-year institution should review with their advisor the transferability of their courses and should review the program requirements of that school. The following schedule is illustrative only; an individual student's schedule may be different.

Business Electives	16
WR121 English Composition	4
WR227 Technical Report Writing	4
AGR280 CWE AG	2
CSS100 Soils and Fertilizers	3
AGM131 Agriculture Safety	3
AGM140 Agriculture Engines	3
AGM221 Metals and Welding	3
AGM211 Agriculture Construction & Surveying	3
AGR101 Agriculture Orientation	1
AGR111 Agriculture Computers	3
AGR200 Pre-Employment Seminar	1
AGR210 Agriculture Accounting	4
AGR211 Agriculture Business Management	3
AGR226 Agriculture Issues	3
AGR296 Production Problems	4
AGR221 Agriculture Marketing	3
ANS121 Animal Science	3
ANS122 Animal Science	3
COM111 Fundamentals of Speech (or higher)	4
MTH095 Intermediate Algebra (or higher)	5
HORT100 Plant Science	3
CSS210 Forage Crops	3
EC201 Principles of Economics/Microeconomics	4
EC202 Principles of Economics/Macroeconomics	4
HE252 First Aid	3
or	
HPE295 Health & Fitness for Life	(3)
TOTAL CREDITS:	95

A.A.S./Agriculture Production



Agriculture, Food and Natural Resources Systems

Intended Program Outcomes:

This two-year program leading to an A.A.S. degree in agriculture production will prepare the student concerned with the raising of an agriculture crop commodity by providing the necessary knowledge in the following areas:

- Industry-related employment skills
- Animal science (techniques, issues, technology, trends)
- Crop science (techniques, issues, technology, trends)
- Agriculture-related business practices
- Agricultural operations (safety, mechanical technology)

The curriculum includes a balanced selection of courses in the areas of crops, mechanics and business. Students wishing to specialize in a particular area should consult their advisor to develop an academic plan. The following schedule is illustrative only; an individual student's schedule may be different.

HE252 First Aid	3
HORT100 Plant Science	3
CSS210 Forage Crops	3
WR065 Introduction to Technical Writing (or higher)	3
RNG241 Range Management	3
COM100 Human Communications (or higher)	4
ANS122 Animal Science	3
ANS121 Animal Science	3
AGR221 Agriculture Marketing	3
AGR296 Production Problems	4
AGR226 Agriculture Issues	3
AGR211 Agriculture Business Management	3
AGR210 Agriculture Accounting	4
AGR200 Pre-Employment Seminar	1
AGR111 Agriculture Computers	3
AGR101 Agriculture Orientation	1
AGM241 Agriculture Machinery	3
AGM240 Tractors	2
AGM211 Agriculture Construction & Surveying	3
AGM221 Metals and Welding	3
AGM140 Agriculture Engines	3
AGM131 Agriculture Safety	3
CSS100 Soils and Fertilizers	3
CSS201 Principles of Crop Science	3
AGR280 CWE AG	3
MTH070 Elementary Algebra	5
Agriculture Electives	12
Human Relations	3
TOTAL CREDITS:	93

FOOD AND NATURAL RESOURCES PATHWAY

A.A.S./Agriculture Production: Crops Option



Agriculture, Food and Natural Resources Systems

Intended Program Outcomes:

This two-year program leading to an A.A.S. in agriculture production: crops, will prepare the student concerned with the raising of an agriculture crop commodity by providing the necessary knowledge in the following areas:

- Industry-related employment skills
- Animal science (techniques, issues, technology, trends)
- Crop science (techniques, issues, technology, trends)
- Agriculture-related business practices
- Agricultural operations (safety, mechanical technology)

The curriculum includes a balanced selection of courses in the areas of crops, mechanics and business. Students wishing to specialize in a particular area should consult their advisor to develop an academic plan. The following schedule is illustrative only; an individual student's schedule may be different.

Human Relations	3
MTH070 Elementary Algebra (or higher)	5
AGR280 CWE AG	5
CSS100 Soils and Fertilizers	3
AGM131 Agriculture Safety	3
AGM140 Agriculture Engines	3
AGM221 Metals and Welding	3
AGM211 Agriculture Construction & Surveying	3
AGM240 Tractors	2
AGM250 Irrigation Systems Design	3
AGM251 Irrigation Systems	3
AGM241 Agriculture Machinery	3
AGR101 Agriculture Orientation	1
AGR111 Agriculture Computers	3
AGR200 Pre-Employment Seminar	1
AGR210 Agriculture Accounting	4
AGR211 Agriculture Business Management	3
AGR226 Agriculture Issues	3
AGR296 Production Problems	4
AGR221 Agriculture Marketing	3
ANS121 Animal Science	3
ANS122 Animal Science	3
RNG241 Range Management	3
COM100 Human Communications (or higher)	4
WR065 Introduction to Technical Writing (or higher)	3
CSS210 Forage Crops	3
CSS240 Pest Management	4
CSS201 Principles of Crop Science	3
HORT100 Plant Science	3
HORT111 Alternative Crop Production	3
HE252 First Aid	3
TOTAL CREDITS: 96	

A.A.S./Agriculture Production: Livestock Option



Agriculture, Food and Natural Resources Systems

Intended Program Outcomes:

This two-year program leading to an A.A.S. degree in agriculture production: livestock, will prepare the student concerned with the raising of an agriculture livestock commodity by providing the necessary knowledge in the following areas:

- Industry-related employment skills
- Animal science (techniques, issues, technology, trends)
- Crop science (techniques, issues, technology, trends)
- Agriculture-related business practices
- Agricultural operations (safety, mechanical technology)

The curriculum includes a balanced selection of courses in the areas of crops, livestock, mechanics and business. Students wishing to specialize in a particular area should consult their advisor to develop an academic plan. The following schedule is illustrative only; an individual student's schedule may be different.

MTH070 Elementary Algebra (or higher)	5
AGR280 CWE AG	4
ANS216 Pregnancy Testing/Bovine	1
ANS201 Introduction to Equine Science	3
Human Relations	3
CSS201 Principles of Crop Science	3
CSS100 Soils and Fertilizers	3
ANS240 Animal Health	5
ANS220 Beef Production	4
ANS231 Livestock Evaluation	3
AGM221 Metals and Welding	3
AGM140 Agriculture Engines	3
AGM131 Agriculture Safety	3
AGM240 Tractors	2
AGM241 Agriculture Machinery	3
AGR101 Agriculture Orientation	1
AGR111 Agriculture Computers	3
AGR200 Pre-Employment Seminar	1
AGR226 Agriculture Issues	3
AGR211 Agriculture Business Management	3
ANS211 Animal Nutrition	4
ANS217 Artificial Insemination	3
ANS122 Animal Science	3
ANS121 Animal Science	3
AGR296 Production Problems	4
RNG241 Range Management	3
COM100 Human Communications (or higher)	4
WR065 Introduction to Technical Writing (or higher)	3
CSS210 Forage Crops	3
HORT100 Plant Science	3
HE252 First Aid	3
TOTAL CREDITS: 95	

BUSINESS AND MANAGEMENT PATHWAY

Accounting: Bookkeeping Support Specialist Career Pathways Certificate of Completion (CPCC)



Business and Management

Intended Program Outcomes:

This one-year program leading to a certificate in accounting offers students the opportunity to develop a foundational understanding of accounting principles with an emphasis in applying that understanding to bookkeeping tasks. Learning experiences in this program are designed to assist the student in realizing the following outcomes:

- Use current computer technologies, especially spreadsheet and accounting software, to perform the duties within an accounting department
- Balance and reconcile financial information to ensure accuracy of information
- Use reconciliation processes when working with data to identify and correct errors
- Prepare professional financial statements and other reporting documents
- Model effective customer-service interactions
- Ability to effectively seek and respond to accounting-related opportunities for increased responsibilities and professional advancement
- Understand the various business functions as they contribute to the success of an organization

Employment possibilities include bookkeeper, accounting clerk and payroll clerk. Jobs are available in business, industry, government agencies, service industries and banks.

TERM 1

BA131 Introduction to Business Computing	4
BA111 Basic Accounting	4
BA104 Business Mathematics	4
or	
MTH095 Intermediate Algebra	(5)

TERM 1 Total: 12

TERM 2

BT220 Calculating Machines	3
BA110X Business Computer Applications/MS Excel	3
BA211 Principles of Accounting	4

TERM 2 Total: 10

TERM 3

BA212 Principles of Accounting	4
BA209Q Accounting Applications/QuickBooks	3

TERM 3 Total: 7
TOTAL CREDITS: 29

Accounting Technician Certificate



Business and Management

Intended Program Outcomes:

This one-year program leading to a certificate in accounting offers students the opportunity to develop a foundational understanding of accounting principles with an emphasis in applying that understanding to bookkeeping tasks. Learning experiences in this program are designed to assist the student in realizing the following outcomes:

- Use current computer technologies, especially spreadsheet and accounting software, to perform the duties within an accounting department
- Balance and reconcile financial information to ensure accuracy of information
- Use reconciliation processes when working with data to identify and correct errors
- Prepare professional financial statements and other reporting documents
- Model effective customer-service interactions
- Ability to effectively seek and respond to accounting-related opportunities for increased responsibilities and professional advancement
- Understand various business functions as they contribute to the success of an organization

Employment possibilities include bookkeeper, accounting clerk and payroll clerk. Jobs are available in business, industry, government agencies, service industries and banks.

TERM 1

BA101 Introduction to Business	4
BA131 Introduction to Business Computing	4
BA111 Basic Accounting	4
BA104 Business Mathematics	4
Or	
MTH095 Intermediate Algebra (or higher)	(5)

TERM 1 Total: 16

TERM 2

BA110X Business Computer Applications/MS Excel	3
BA177 Payroll Accounting	4
BA211 Principles of Accounting	4
WR121 English Composition	4
BA105 Business Mathematics	4
Or	
MTH095 Intermediate Algebra (or higher)	(5)

TERM 2 Total: 19

TERM 3

BT220 Calculating Machines	3
COM111 Fundamentals of Speech	4
BA212 Principles of Accounting	4
BA209Q Accounting Applications/QuickBooks	3
BA284 Pre-Employment Seminar	1
BA285 Human Relations in Business	3

TERM 3 Total: 18
TOTAL CREDITS: 53

BUSINESS AND MANAGEMENT PATHWAY

A.A.S./Accounting Technology



Business and Management

Intended Program Outcomes:

This two-year program leading to an A.A.S. degree in accounting offers students the opportunity to develop an advanced understanding of accounting principles. Learning experiences in this program are designed to assist the student in realizing the following outcomes:

- Use of current computer technologies, especially spreadsheet and accounting software, to perform the duties within a business setting
- Balance and reconcile financial information to ensure accuracy of information
- Analyze financial data in order to understand it and to use the data to make decisions
- Use reconciliation processes when working with data to identify and correct errors
- Prepare professional financial statements and other reporting documents
- Preparation for licensure process within the state of Oregon to prepare tax returns
- Ability to effectively seek and respond to accounting-related opportunities for increased responsibilities and professional advancement
- Understand the various business functions as they contribute to the success of an organization

TERM 1

BA131 Introduction to Business Computing	4
BA101 Introduction to Business	4
BA111 Basic Accounting	4
BA104 Business Mathematics	4
or	
MTH095 Intermediate Algebra (or higher)	(5)

TERM 1 Total: 16

TERM 2

BT220 Calculating Machines	3
BA110X Business Computer Applications/MS Excel	3
BA211 Principles of Accounting	4
BA155 Introduction to Fraud Examination	3
BA105 Business Mathematics	4
or	
MTH095 Intermediate Algebra (or higher)	(5)

TERM 2 Total: 17

TERM 3

BA210 Microcomputer Application/Advanced Excel	3
BA212 Principles of Accounting	4
BA220 Tax Accounting	4
WR121 English Composition	4

TERM 3 Total: 15

TERM 4

BA221 Accounting Problems/Tax	4
BA226 Business Law	4
BA213 Principles of Accounting	4
BT121 Document Processing I	3

TERM 4 Total: 15

TERM 5

BA177 Payroll Accounting	4
BA261 Intermediate Accounting	4
BA215 Cost Accounting	4
BA116 Bookkeeping Practice	2

TERM 5 Total: 14

TERM 6

BA268 Introduction to Auditing	3
BA209Q Accounting Applications/QuickBooks	3
BA284 Pre-Employment Seminar	1
BA285 Human Relations in Business	3
COM111 Fundamentals of Speech	4

TERM 6 Total: 14

TOTAL CREDITS: 91

Administrative Office Professional: Office Support Specialist Career Pathway Certificate of Completion (CPCC)



Business and Management

Intended Program Outcomes:

This program leads to a career pathways certificate of completion in administrative assistant/office support specialist offering students the opportunity to develop entry-level office skills.

Learning experiences in this program are designed to assist the student in realizing the following outcomes:

- Demonstrates the ability to solve problems in a business environment
- Understand and perform the general office functions.
- Perform various basic math calculations required in an office/business environment
- Discuss the professional image that is expected of office personnel
- Develop awareness for ethical and/or human relation standards in the workplace
- Produce clear, concise and mechanically-correct documents
- Meet or exceed the current speed and accuracy requirements for document processing
- Demonstrate the ability to use appropriate technology (word processing, spreadsheet, database and presentation software) in the business environment

TERM 1

BT121 Document Processing I	3
BT116 Professional Office Procedures	3
BA104 Business Mathematics	4

TERM 1 Total: 10

TERM 2

BA131 Introduction to Business Computing	4
BT140 Business Document Editing	3
BT201M Word Processing/ MS Word	3
or	
BT206 Desktop Publishing	(3)

TERM 2 Total: 10

TERM 3

BA110X Business Computer Applications/MS Excel	3
BA285 Human Relations in Business	3
or	
BA277 Business Ethics	(3)

TERM 3 Total: 6

TOTAL CREDITS: 26

BUSINESS AND MANAGEMENT PATHWAY

A.A.S./Administrative Office Professional



Business and Management

Intended Program Outcomes:

This program leading to an A.A.S. degree in administrative assistant offers students the opportunity to develop top-level office skills. Learning experiences in this program are designed to assist the student in realizing the following outcomes:

- Use current and emerging word processing technologies to produce organizational documents and presentation materials
- Meet or exceed the current speed and accuracy requirements for typing and 10-key operation in the industry
- Individually and collaboratively manage multiple office tasks, prioritizing and reprioritizing in response to changing demands
- Assess the image that is expected of office personnel in a specific industry group; reflect those expectations in personal appearance, professional conduct and personal hygiene.
- Produce clear, concise and mechanically correct written documents
- Model effective customer service interactions
- Seek and respond to opportunities for increased responsibilities and professional advancement
- Understand office functions as they contribute to sound business practices and procedures
- Perform the general office procedures of filing, equipment operation, mail distribution, phone calls, and tasks requiring basic math calculations (such as inventory)

TERM 1

BA101 Introduction to Business	4
BT116 Professional Office Procedures	3
BT121 Document Processing I	3
WR121 English Composition	4

TERM 1 Total: 14

TERM 2

BT122 Document Processing II	3
BT140 Business Document Editing	3
BA131 Introduction to Business Computing	4
BA104 Business Mathematics	4
or	
MTH095 Intermediate Algebra	(5)

TERM 2 Total: 14

TERM 3

BT123 Document Processing III	3
BT220 Calculating Machines	3
COM111 Fundamentals of Speech	4
BA110X Business Computer Applications/MS Excel	3
BA214 Business Communications	3

TERM 3 Total: 16

TERM 4

BA226 Business Law	4
BT124 Keyboarding for Speed & Accuracy	3
BT201M Word Processing/ MS Word	3
BA277 Business Ethics	3
or	
BA285 Human Relations in Business	(3)
BA111 Basic Accounting	4
or	
BA211 Principles of Accounting	(4)

TERM 4 Total: 17

TERM 5

BA284 Pre-Employment Seminar	1
BA224 Human Resource Management	3
BA110A Business Computer Applications/MS Access	3
BT202M Word Processing/ MS Word	3
HTM131 Customer Service Management I	3
AOP Preapproved Electives	4

TERM 5 Total: 17

TERM 6

BA280 CWE Business	3
BT206 Desktop Publishing	3
BA209Q Accounting Applications/QuickBooks	3
BA206 Principles of Management	4
BT290 Integrated Office Systems	3
or	
BA280 CWE Business	(3)

TERM 6 Total: 16
TOTAL CREDITS: 94



BUSINESS AND MANAGEMENT PATHWAY

A.A.S./Administrative Office Professional: Legal Option



Business and Management

Intended Program Outcomes:

This two-year program leading to an A.A.S. in administrative office assistant, legal option, provides students with the specialized skills necessary for employment as legal administrative assistants. Students will be effective in the workplace in the following areas:

- Use of appropriate legal terminology with written and oral accuracy
- Use of transcription machines effectively to produce legal documents
- Office bookkeeping and general accounting tasks
- Effective use of database and spreadsheet software
- Understanding of the legal system

TERM 1

WR121 English Composition	4
CJ Electives	3
BT121 Document Processing I	3
BT131 Legal Office Procedures	3
or	
BT116 Professional Office Procedures	(3)

TERM 1 Total: 13

TERM 2

BT140 Business Document Editing	3
BT122 Document Processing II	3
CJ Electives	3
BT230 Legal Terminology I	3
BA104 Business Mathematics	4
or	
MTH095 Intermediate Algebra (or higher)	(5)

TERM 2 Total: 16

TERM 3

BT123 Document Processing III	3
BT220 Calculating Machines	3
BA131 Introduction to Business Computing	4
BA285 Human Relations in Business	3
BT232 Legal Terminology II	3

TERM 3 Total: 16

TERM 4

BA277 Business Ethics	3
BA111 Basic Accounting	4
BT124 Keyboarding for Speed & Accuracy	3
BT201M Word Processing/ MS Word	3
CJ220 Criminal Law	3
or	
BA226 Business Law	(4)

TERM 4 Total: 16

TERM 5

BA284 Pre-Employment Seminar	1
BA110X Business Computer Applications/MS Excel	3
BT202M Word Processing/ MS Word	3
COM111 Fundamentals of Speech	4
BA280 CWE Business	3
HTM131 Customer Service Management I	3

TERM 5 Total: 17

TERM 6

BT231 Legal Transcription	3
BT206 Desktop Publishing	3
BA206 Principles of Management	4
BA209Q Accounting Applications/QuickBooks	3
BA214 Business Communications	3
or	
WR227 Technical Report Writing	(4)

TERM 6 Total: 16

TOTAL CREDITS: 94

A.A.S./Administrative Office Professional: Medical Option



Business and Management



Health Services

Intended Program Outcomes:

This two-year program leading to an A.A.S. in administrative office assistant, medical option, provides students with the specialized skills necessary for employment as medical administrative assistants. Students will be effective in the workplace in the following areas:

- Use of appropriate medical terminology with written and oral accuracy
- Use of transcription equipment effectively to produce medical documents
- Office bookkeeping and general accounting tasks
- Effective use of database and spreadsheet software

TERM 1

WR121 English Composition	4
BT251 Medical Terminology	3
BT121 Document Processing I	3
BT116 Professional Office Procedures	3

TERM 1 Total: 13

TERM 2

BT122 Document Processing II	3
BT252 Medical Terminology	3
BT140 Business Document Editing	3
BA131 Introduction to Business Computing	4
BA104 Business Mathematics	4
or	
MTH095 Intermediate Algebra (or higher)	(5)

TERM 2 Total: 17

TERM 3

BT123 Document Processing III	3
BT220 Calculating Machines	3
BT257 Medical Office Procedures	3
BA110X Business Computer Applications/MS Excel	3
BA285 Human Relations in Business	3

TERM 3 Total: 15

TERM 4

BT253 Medical Transcription	3
BT124 Keyboarding for Speed & Accuracy	3
BT201M Word Processing/ MS Word	3
BA111 Basic Accounting	4
BA277 Business Ethics	3

TERM 4 Total: 16

TERM 5

HTM131 Customer Service Management I	3
BT202M Word Processing/ MS Word	3
BT254 Medical Transcription	3
COM111 Fundamentals of Speech	4
BA284 Pre-Employment Seminar	1
BA177 Payroll Accounting	4

TERM 5 Total: 18

TERM 6

BA209Q Accounting Applications/QuickBooks	3
BA214 Business Communications	3
BA110A Business Computer Applications/MS Access	3
BT258 Medical Insurance Procedures & Coding	3
BT206 Desktop Publishing	3
BA280 CWE Business	2

TERM 6 Total: 17

TOTAL CREDITS: 96

BUSINESS AND MANAGEMENT PATHWAY

Business Administration: Business Operations Support Specialist Career Pathways Certificate of Completion (CPCC)



Business and Management

Intended Program Outcomes:

This program leads to a career pathways certificate of completion in administrative assistant/office support specialist offering students the opportunity to develop entry-level office skills. Learning experiences in this program are designed to assist the student in realizing the following outcomes:

- Understand various functions in the business environment
- Maintain complete and accurate business records
- Assist with performing various business functions and solve problems in a business environment
- Perform various basic math calculations required in an office/business environment
- Develop awareness for ethical and/or human relation standards in the workplace
- Produce clear, concise, and mechanically-correct written documents
- Use verbal, non-verbal, and written communication skills effectively in the business context
- Meet or exceed the current speed and accuracy requirements for document processing
- Use appropriate technology (word processing, spreadsheet, database and presentation software) in the office/business environment

TERM 1

BA101 Introduction to Business	4
BA131 Introduction to Business Computing	4
BA111 Basic Accounting	4
BA104 Business Mathematics	4
or	
MTH095 Intermediate Algebra (or higher)	(5)
TERM 1 Total:	16

TERM 2

BT121 Document Processing I	3
BA110X Business Computer Applications/MS Excel	3
TERM 2 Total:	6

TERM 3

COM111 Fundamentals of Speech	4
WR121 English Composition	4
TERM 3 Total:	8
TOTAL CREDITS:	30

A.A.S./Business Administration



Business and Management

Intended Program Outcomes:

This two-year A.A.S. degree program will prepare the student to either transfer to an Oregon University System institution on a course-by-course basis or to be effective in the workplace in the following areas:

- Establish and promote a collaborative work environment where all voices are heard and valued as they contribute to shared goal
- Work within the ethical, legal, and regulatory parameters of the industry
- Calculate, compile and analyze financial records to make practical business decisions
- Attract, screen, hire, train, and supervise personnel
- Select and integrate appropriate current and emerging technologies to support business functions
- Use verbal, non-verbal and written communication skills effectively in the business context
- Interact effectively with clients and customers
- Use critical thinking skills to solve business problems
- Exhibit work behaviors that maximize opportunity for continued employment, increased responsibilities and business success
- Lead a work unit in a direction that aligns with stated organizational vision, mission and values.

TERM 1

BA111 Basic Accounting	4
BA101 Introduction to Business	4
BA131 Introduction to Business Computing	4
BA104 Business Mathematics	4
or	
MTH095 Intermediate Algebra (or higher)	(5)
TERM 1 Total:	16

TERM 2

BT220 Calculating Machines	3
BA110X Business Computer Applications/MS Excel	3
BA211 Principles of Accounting	4
BA155 Introduction to Fraud Examination	3
BA105 Business Mathematics	4
or	
MTH095 Intermediate Algebra (or higher)	(5)
TERM 2 Total:	17

TERM 3

BT121 Document Processing I	3
COM111 Fundamentals of Speech	4
BA212 Principles of Accounting	4
BA210 Microcomputer Application/Advanced Excel	3
WR121 English Composition	4
TERM 3 Total:	18

TERM 4

BA277 Business Ethics	3
BA213 Principles of Accounting	4
BA226 Business Law	4
BA224 Human Resource Management	3
BT201M Word Processing/ MS Word	3
TERM 4 Total:	17

TERM 5

BA215 Cost Accounting	4
BA223 Principles of Marketing	4
BA177 Payroll Accounting	4
HTM131 Customer Service Management I	3
TERM 5 Total:	15

TERM 6

BA206 Principles of Management	4
BA214 Business Communications	3
BA249 Retail Selling	3
BA284 Pre-Employment Seminar	1
BA110A Business Computer Applications/MS Access	3
TERM 6 Total:	14
TOTAL CREDITS:	97

BUSINESS AND MANAGEMENT PATHWAY

Hospitality, Tourism, and Management Certificate



Business and Management



Human Resources



Intended Program Outcomes:

This one-year program introduces students to the field of the hospitality industry, including tourism, travel, and management. Online and classroom instruction and cooperative work experience offer students a look into the day-to-day experiences at hospitality and tourism sites. Students will be effective in the workplace in the following areas:

- Learning experiences in this program are designed to assist the student in realizing the following outcomes:
- Identify specific hospitality industry functions and their required procedures and legal techniques
- Understand and apply market-appropriate professional guest service standards to deliver competitive guest experiences to diverse cultural groups and throughout business and industry
- Identify general business functions to maintain day-to-day operations
- Demonstrate the ability to solve mathematical problems commonly encountered in hospitality-related business setting
- Utilize the technical/computer skills for keeping business records and preparing basic financial statements
- Identify techniques for successfully managing human resources and human relations in business
- Utilize various techniques for effect verbal and written communications
- Prepare general documents related to career searches and job applications.

This certificate helps prepare students for entry-level positions in management and helps students develop the professionalism necessary for business success and upward mobility in the hospitality and tourism industry.

TERM 1

HTM131 Customer Service Management I	3
BA131 Introduction to Business Computing	4
HTM100 Hospitality & Tourism Industry	3
BA104 Business Mathematics	4
or	
MTH095 Intermediate Algebra (or higher)	(5)
BT120 Computer Keyboarding	2
or	
BT121 Document Processing I	(3)
TERM 1 Total:	16

TERM 2

COM111 Fundamentals of Speech	4
BA223 Principles of Marketing	4
WR121 English Composition	4
HTM226 Event Management	3
TERM 2 Total:	15

TERM 3

HTM230 Hotel, Restaurant and Travel Law	3
BA280 CWE Business	3
BA225 Introduction to Gaming Management	4
BA284 Pre-Employment Seminar	1
BA285 Human Relations in Business	3
or	
BA277 Business Ethics	(3)

TERM 3 Total: 14
TOTAL CREDITS: 45

BUSINESS AND MANAGEMENT PATHWAY

A.A.S./Business Administration Hospitality and Gaming Option



Business and Management



Human Resources

Intended Program Outcomes:

This two-year A.A.S. degree program will prepare the student to either transfer to an Oregon University System institution on a course-by-course basis or to be effective in the workplace in the following areas:

- Establish and promote a collaborative work environment where all voices are heard and valued as they contribute to shared goal
- Work within the ethical, legal, and regulatory parameters of the industry
- Calculate, compile, and analyze financial records to make practical business decisions
- Attract, screen, hire, train, and supervise personnel
- Select and integrate appropriate current and emerging technologies to support business functions
- Use verbal, non-verbal, and written communication skills effectively in the business context
- Interact effectively with clients and customers
- Use critical thinking skills to solve business problems
- Exhibit work behaviors that maximize opportunity for continued employment, increased responsibilities, and business success
- Assist in the design, implementation, and continuous assessment of business strategies based on consumer needs and market changes
- Lead a work unit in a direction that aligns with stated organizational vision, mission, and values
- Gain a basic foundation in hospitality and gaming business practices.
- Provide various business principles and practices.
- Promote job advancement, professional growth and career mobility within the hospitality/gaming industry.

The program offers a combination of online and on-campus instruction along with cooperative work experience to give students a look at day-to-day experiences and decisions in the business world.

Important Program Notes: Students who expect to work in gaming industry will most likely be subject to passing background checks and age requirements to gain employment. CWE classes should be completed in hospitality, gaming, or restaurant industry or in a closely related industry.

TERM 1

WR121 English Composition	4
HTM131 Customer Service Management I	3
HTM100 Hospitality & Tourism Industry	3
BT201M Word Processing/ MS Word	3
or	
BT121 Document Processing I	(3)
BA104 Business Mathematics	4
or	
MTH095 Intermediate Algebra (or higher)	(5)

TERM 1 Total: 17

TERM 2

BA131 Introduction to Business Computing	4
BA249 Retail Selling	3
BA107 Survey of Gaming Regulations	4
BA155 Introduction to Fraud Examination	3

TERM 2 Total: 14

TERM 3

BA225 Introduction to Gaming Management	4
HTM230 Hotel, Restaurant and Travel Law	3
BA110X Business Computer Applications/MS Excel	3
COM111 Fundamentals of Speech	4
BA277 Business Ethics	3
or	
BA285 Human Relations in Business	(3)

TERM 3 Total: 17

TERM 4

BA224 Human Resource Management	3
BA211 Principles of Accounting	4
COM115 Intercultural Communication	4
HTM226 Event Management	3
BA280 CWE Business	2

TERM 4 Total: 16

TERM 5

BA280 CWE Business	3
BA106 Supervision of Table Games	4
BA212 Principles of Accounting	4
BA223 Principles of Marketing	4

TERM 5 Total: 15

TERM 6

BA214 Business Communications	3
BA213 Principles of Accounting	4
BA206 Principles of Management	4
BA108 Slots Management I	4

TERM 6 Total: 15

TOTAL CREDITS: 94



BUSINESS AND MANAGEMENT PATHWAY

A.A.S./Hospitality Management



Business and Management



Human Resources

Intended Program Outcomes:

This two-year program will prepare the student either to transfer to an Oregon University System institution on a course-by-course basis, or be effective in a career as manager in the hospitality and tourism industries by having the requisite knowledge in the following areas:

- Identify, understand and apply market-appropriate professional guest service standards to deliver competitive guest experiences to diverse cultural groups
- Identify specific hospitality industry functions and their required procedures and legal techniques
- Identify techniques for successfully managing human resources and human relations in business
- Analyze financial statements, isolate potential problems, and identify appropriate corrective action to control and manage the critical revenue and cost centers
- Demonstrate the ability to solve mathematical problems commonly encountered in hospitality related business setting
- Utilize the technical/computer skills for keeping business records and preparing financial statements
- Develop skills for human relations activities for day-to-day business operations
- Write effective routine, routing, and persuasive styles of written communication
- Employ effective verbal communications in a variety of settings
- Develop skills for social/professional aspects of conducting business with individuals and groups
- Prepare marketing and presentation documents for marketing of business

TERM 1

HTM131 Customer Service Management I	3
HTM100 Hospitality & Tourism Industry	3
BA131 Introduction to Business Computing	4
BA104 Business Mathematics	4
or	
MTH095 Intermediate Algebra (or higher)	(5)

TERM 1 Total: 14

TERM 2

HTM109 Front Desk Operations	3
HTM105 Food & Beverage Industry	3
SOC204 General Sociology	4
WR121 English Composition	4

TERM 2 Total: 14

TERM 3

BA280 CWE Business	3
HTM107 Hospitality Cost Control	3
HTM127 Selling in Hospitality & Tourism	3
HTM130 Beverages	3
GEOG206 Geography of Oregon	4
or	
GEOG120 World/Regional Geography	(4)

TERM 3 Total: 16

TERM 4

COM111 Fundamentals of Speech	4
BA211 Principles of Accounting	4
HTM232 Menu Design	3
HTM226 Event Management	3
HTM224 Catering Operations	3

TERM 4 Total: 17

TERM 5

WR227 Technical Report Writing	4
BA277 Business Ethics	3
BA223 Principles of Marketing	4

BA284 Pre-Employment Seminar	1
COM115 Intercultural Communication	4

TERM 5 Total: 16

TERM 6

BT206 Desktop Publishing	3
BA206 Principles of Management	4
BA285 Human Relations in Business	3
HTM230 Hotel, Restaurant and Travel Law	3
BA280 CWE Business	3

TERM 6 Total: 16
TOTAL CREDITS: 93



BUSINESS AND MANAGEMENT PATHWAY

Office Assistant Certificate



Business and Management

Intended Program Outcomes:

This one-year certificate program is designed to provide specialized training and skills for work as an office assistant. Emphasis is placed on the study of general office skills, including practical experience on current equipment and software. The course work lays the foundation for a two-year A.A.S. degree program for those students who want to continue their education. Students will be effective in the workplace in the following areas:

- Use current and emerging word-processing technologies to produce documents
- Meet or exceed the current speed and accuracy requirements for typing and 10-key operation in the industry
- Model effective customer service interactions
- Perform the general office procedures of filing, equipment operation, mail distribution, phone calls, and tasks requiring basic math calculations

TERM 1

BT121 Document Processing I	3
BT116 Professional Office Procedures	3
BA101 Introduction to Business	4
WR121 English Composition (or higher)	4

TERM 1 Total: 14

TERM 2

BA131 Introduction to Business Computing	4
BT122 Document Processing II	3
BT140 Business Document Editing	3
BA104 Business Mathematics	4
or	
MTH095 Intermediate Algebra (or higher)	(5)
BA277 Business Ethics	3
or	
BA285 Human Relations in Business	(3)

TERM 2 Total: 17

TERM 3

BA284 Pre-Employment Seminar	1
BA110X Business Computer Applications/MS Excel	3
BT123 Document Processing III	3
BT220 Calculating Machines	3
COM111 Fundamentals of Speech	4
BT206 Desktop Publishing	3
or	
BT201M Word Processing/ MS Word	(3)

TERM 3 Total: 17

TOTAL CREDITS: 48

Office Assistant: Medical Option Certificate



Business and Management



Health Services

Intended Program Outcomes:

This one-year certificate program is designed to provide specialized training and skills for entry-level positions as receptionists and/or records clerks in medical offices. Emphasis is placed on the study of general office skills as well as medical office theories and policies, including practical experience on current equipment and software. The course work lays the foundation for a two-year A.A.S. degree program for those students who want to continue their education.

- Use current and emerging word processing technologies to produce documents
- Meet or exceed the current speed and accuracy requirements for typing and 10-key operation in the industry
- Model effective customer service interactions
- Perform the general office procedures of filing, equipment operation, mail distribution, phone calls, and tasks requiring basic math calculations
- Use appropriate medical terminology with written and oral accuracy

TERM 1

BT251 Medical Terminology	3
BT116 Professional Office Procedures	3
BT121 Document Processing I	3
WR121 English Composition	4
BA104 Business Mathematics	4
or	
MTH095 Intermediate Algebra (or higher)	(5)

TERM 1 Total: 17

TERM 2

BT122 Document Processing II	3
BT252 Medical Terminology	3
BT140 Business Document Editing	3
BA131 Introduction to Business Computing	4
BA277 Business Ethics	3
or	
BA285 Human Relations in Business	(3)

TERM 2 Total: 16

TERM 3

BA284 Pre-Employment Seminar	1
BA110X Business Computer Applications/MS Excel	3
BT123 Document Processing III	3
BT220 Calculating Machines	3
BT257 Medical Office Procedures	3
BT206 Desktop Publishing	3
or	
BT201M Word Processing/ MS Word	(3)

TERM 3 Total: 16

TOTAL CREDITS: 49

BUSINESS AND MANAGEMENT PATHWAY

Retail Management Certificate (less than one year)



Business and Management



Human Resources

Intended Program Outcomes:

This less-than-one-year certificate program is for current retail employees and for students who would like to become retail employees. This program is recognized by WAFB retail employers and identifies skills that lead to professional growth, hiring, and advancement opportunities. The program prepares the student for retail sales and management responsibilities; those who complete the program may be given preference in hiring, may be eligible for promotions, and may receive compensation to recognize their educational achievement. Learning experiences in this program are designed to assist the student in realizing the following outcomes:

- Define the different types of retail outlets and related principles for successful businesses
- Illustrate unique, competitive marketing strategies for retailers including advertising, public relations, and sales promotion packages
- Demonstrate the ability to use the computer and information services for business-related activities
- Understand the principles and methods for human resource/human relations management
- Demonstrate the ability to solve mathematical problems commonly encountered in hospitality-related business settings
- Utilize the technical skills for keeping business records and preparing financial statements
- Write effective routine, routing, and persuasive styles of written communication
- Employ successful verbal communication in a variety of settings

TERM 1

BA211 Principles of Accounting	4
BA224 Human Resource Management	3
BA104 Business Mathematics	4
or	
MTH095 Intermediate Algebra (or higher)	(5)

TERM 1 Total: 11

TERM 2

BA131 Introduction to Business Computing	4
BA249 Retail Selling	3
BA223 Principles of Marketing	4

TERM 2 Total: 11

TERM 3

BA214 Business Communications	3
BA206 Principles of Management	4
BA285 Human Relations in Business	3
COM111 Fundamentals of Speech	4

TERM 3 Total: 14

TOTAL CREDITS: 36

Retail Management Certificate



Business and Management



Human Resources

Intended Program Outcomes:

This certificate program focuses on developing core skills needed for entry-level sales or management positions in the retail industry. This one-year certificate program is designed to assist the student in realizing the following outcomes:

- Define the different types of retail outlets and related principles for successful businesses
- Illustrate unique, competitive marketing strategies for retailers including advertising, public relations, and sales promotion packages
- Demonstrate the ability to use the computer and information services for business-related activities
- Understand the principles and methods for human resource/human relations management
- Demonstrate the ability to solve mathematical problems commonly encountered in hospitality-related business settings
- Utilize the technical skills for keeping business records and preparing financial statements
- Write effective routine, routing, and persuasive styles of written communication
- Employ successful verbal communication in a variety of settings

TERM 1

BA131 Introduction to Business Computing	4
BA224 Human Resource Management	3
BA211 Principles of Accounting	4
BA104 Business Mathematics	4
or	
MTH095 Intermediate Algebra (or higher)	(5)

TERM 1 Total: 15

TERM 2

BA249 Retail Selling	3
BA223 Principles of Marketing	4
BA285 Human Relations in Business	3
WR121 English Composition	4
Business Electives	3

TERM 2 Total: 17

TERM 3

Business Electives	4
BA214 Business Communications	3
BA206 Principles of Management	4
COM111 Fundamentals of Speech	4

TERM 3 Total: 15

TOTAL CREDITS: 47

HEALTH SERVICES PATHWAY

Dental Assisting Technician Certificate



Health Services

(Limited-Entry Program)

Intended Program Outcomes:

This one-year certificate program will prepare the student to be effective in the workplace in the following areas:

- Assist dentist with patient treatment
- Radiographic proficiency (exposure, processing, and mount)
- Material manipulation (selection, classification, safe handling, and disposal)
- Infection control (instrument and room processing to prevent disease transmission, OSHA compliance)
- Business office procedures (computer data entry, scheduling, and records management)
- Employment readiness (professionalism, writing skills, ethics, legal and HIPAA procedures)

Students must receive a "C" grade or above in all prerequisite and dental coursework to be considered as having successfully completed the program.

Admission Requirements

To enroll, you must have a high school diploma or GED certificate. Additional enrollment information is available from the Office of Enrollment Management in Morrow Hall on the BMCC Pendleton campus or online at BMCC's Website. Completed enrollment application materials will be accepted beginning January 1 through the last Friday in April (or until all available positions are filled) for admission for the following fall term. (Applications will not be held over for subsequent years' admission.) Students must meet the criteria below before being accepted to the program.

Dental Assisting Technician Curriculum

Before Fall Term Entry:

The following courses must be completed with a "C" grade or higher by the end of the winter term:

WR060	Elements of the Essay (or higher)	3
COM100	Human Communications (or higher)	4
MTH025	Pre-Algebra (or higher)	4
	Human Relations Courses	4

The following additional requirements must be met before being accepted to the program

- Meet BMCC's computer literacy requirement
- Meet a minimum COMPASS test reading score of 88

On the first day of fall term students must present proof of two MMR (measles, mumps, rubella) vaccinations, a negative tuberculin skin test or chest x-ray, initiation of the Hepatitis B vaccination series and tetanus vaccination, as well as a current Health Care Provider level "C" CPR card that expires after completion of the program. Courses within the dental assisting curriculum can be used as the career and technical credits for the associate degree in general studies.

Pre-requisites

WR060	Elements of the Essay (or higher)	3
MTH025	Pre-Algebra (or higher)	4
COM100	Human Communications (or higher)	4
	Human Relations	4

Pre-requisites Total: 15

TERM 1

DA141	Dental Radiology	4
DA170	Basic Dental Science	3
DA172	Dental Anatomy	4
DA196	Medical Emergencies in the Dental Office	1
DA190	Dental Health Education	2
DA151	Chairside Procedures	3
DA180	Dental Materials	3

TERM 1 Total: 20

TERM 2

DA182	Dental Laboratory Materials and Procedures	2
DA152	Chairside Procedures	3
DA192	Dental Law and Ethics	1
DA174	Dental Pathology	1
DA176	Dental Pharmacology	1
DA154	Dental Specialties	2
DA162	Clinical Practice	4
DA142	Dental Radiology	3

TERM 2 Total: 17

TERM 3

DA143	Dental Radiology	1
DA163	Clinical Practice	8
DA166	Clinical Practice Seminar	1
DA194	Dental Business Office	3
DA153	Chairside Procedures	2

TERM 3 Total: 15
TOTAL CREDITS 67



HEALTH SERVICES PATHWAY

Emergency Medical Technician (EMT) Certificate



Health Services

(Limited-Entry Program)

Intended Program Outcomes:

This one-year program leading to an Emergency Medical Technician certificate offers students the opportunity to prepare for careers in emergency medical services. Learning experiences in this program are designed to assist the student in realizing the following outcomes:

- Assess and treat patients using protocols within the Oregon defined scope of practice in emergency medical situations
- Use verbal and non-verbal skills to communicate with patients, families, bystanders, and other medical professionals
- Accurately observe and document patient care data using a variety of tools and techniques, including providing written and verbal patient reports
- Properly and safely lift and move patients in a variety of medical and rescue situations
- Exhibit respectful, responsive personal behaviors in your personal as well as professional EMS life
- Perform all care in a professional and ethical manner recognizing cultural diversity
- Work in an organized manner and provide leadership during stressful and life-threatening situations

Employment Opportunities:

Career opportunities that may require EMT training include but are not limited to: firefighter (career or volunteer), paramedic, search and rescue, critical care transport, or basic life support transport provider. The EMT certificate can lead to a career as a paramedic if a student wishes to continue his/her studies and completes the requirements for an A.A.S.-EMT (associate of applied science - EMT) degree at an accredited institution.

EMT151 EMT Basic Part A	5
EMT175 Intro to EMS	4
MTH070 Elementary Algebra (or higher)	5
COM111 Fundamentals of Speech	4
BI231 Human Anatomy and Physiology	4
EMT176 Emergency Response Patient Transportation	2
EMT177 Emergency Response Patient Communication/Doc	2
EMT152 EMT Basic Part B	5
BI232 Human Anatomy and Physiology	4
WR121 English Composition (or higher)	4
BI233 Human Anatomy and Physiology	4
EMT169 EMT Rescue	3
EMT115 Crisis Intervention	3
PSY201 General Psychology	4
BT251 Medical Terminology	3
Social Science Courses	3
or	
Arts & Letters (Humanities)	(3)

TOTAL CREDITS: 59



HEALTH SERVICES PATHWAY

A.A.S./Nursing



Health Services

(Limited-Entry Program)

Intended Program Outcomes:

This two-year A.A.S. degree in nursing will prepare the student to sit for testing and licensure as a registered nurse and to be effective in the workplace in the following areas:

- Basing nursing activities on practice as dictated by the theories and concepts from nursing and the natural and behavioral sciences, thereby effectively employing assessment and intervention skills, caring and relational skills for client advocacy, and teaching skills for health promotion and restoration
- Working dependently and interdependently with qualified health professionals and members of the health team in defining, planning, implementing, and evaluating the total health plan for individuals consistent with their graduating scope of practice and skills in communication, cultural respect, management, leadership, and teaching
- Being accountable for his/her own decisions, judgments, and nursing practice by using critical thinking skills, moral and ethical responsibility, and responsibilities management skills
- Exhibiting personal and professional growth by using critical thinking and knowledge integration skills to acquire new knowledge and new experiences with the continual expansion of scientific knowledge and technology

Registered nurses (RNs) use their knowledge, skills, and problem-solving abilities to help individuals, families, and groups with health needs. RNs care for and work with people to help them become healthier or to regain health after illness or surgery. Nurses teach health practices to clients and other health care providers, and frequently supervise the work of nursing assistants and practical nurses. RNs also administer medications and perform treatments for patients. Nurses work in a variety of settings, including hospitals, long-term care, schools, industry, clinics, and patients' homes.

About the Program

BMCC is a member of the Oregon Consortium for Nursing Education (OCNE) and offers a competency-based curriculum jointly developed by nursing faculties from the eight community college and Oregon Health and Science University (OHSU) consortium partners. The core competencies address the need for nurses to be skilled in clinical judgment and critical thinking; evidence-based practice; relationship-centered care; interdisciplinary collaboration; assisting individuals and families in self-care practices for promotion of health and management of chronic and acute illness; end-of-life care; and teaching, delegation, leadership and supervision of caregivers.

Acceptance to the program allows for co-admission to BMCC and OHSU nursing programs. The program is designed as four years of full-time study, with the first year (although it may take longer than one year) devoted to prerequisite/preparatory courses (48 credit minimum) required for admission to the restricted (limited) admission Nursing program. Successful completion of the second and third years leads to an Associate of Applied Science (AAS) Nursing degree offered by BMCC. The OCNE curriculum continues for four additional terms leading to a Bachelor of Science degree with a major in Nursing (BSN) offered by OHSU. See the BMCC Nursing Sample Program of Study at http://www.bluecc.edu/departments_nursing.

The first five terms after admission to the BMCC Nursing program are identical for the associate and bachelor's degree courses. Term six offers students the ability to complete the AAS degree at BMCC and provides the educational eligibility for NCLEX-RN licensure testing or can be used to begin the coursework for the BSN. The latter option allows transfer to an OHSU campus without additional competitive application process to complete coursework for the bachelor's degree with a major in nursing and then become eligible for the NCLEX-RN licensure exam. Students who complete the AAS degree at BMCC and pass the NCLEX-RN exam also have the option to complete the upper division nursing courses for the bachelor's degree from OHSU in a distance-education format with clinical experiences completed locally. Options available for baccalaureate completion can be found at <http://www.ohsu.edu/xd/education/schools/school-of-nursing/programs/undergraduate/cc-transition/index.cfm>.

The Nursing program is approved by the Oregon State Board of Nursing (OSBN), 17938 SW Upper Boones Ferry Road, Portland, OR, 971-673-0685, www.oregon.gov/OSBN.

Entry Requirements

As part of their training, students must begin with the courses within their skill levels as determined by placement test scores. In addition, students may also be required to enroll in classes that would increase their success.

Program admission occurs once per year. Deadline for submitting program application material is February 15, 2013, or the first business day thereafter, for fall term 2013 admission (see program website and/or application packet for more information). Transcripts showing satisfactory completion of the math and Anatomy and Physiology I prerequisites and at least 22 other credits of the prerequisite/preparatory courses (minimum 30 credits) must be in the Registrar's office by the application deadline to be considered eligible. All prerequisite/preparatory courses must have been taken with a letter grade and completed with a "C" or better. Consortium partner schools will use shared standards in a point system and a set of core criteria for evaluation and selection of candidates to the consortium curriculum, but selection processes, acceptance decisions, and admissions will occur at individual schools. Application to the Nursing program requires a minimum GPA of 3.0 for all completed prerequisite/preparatory courses. Contact the Registrar for information regarding the application and selection process.

If an applicant has taken an equivalent course elsewhere which has a course number, title, or credit hour different from the BMCC course, the applicant must contact BMCC's Registrar's office for a transcript evaluation as far in advance of the application deadline as possible. To be admitted into nursing courses, students must complete all required prerequisite and preparatory courses (minimum 48 credits) and be accepted into the Nursing program.

Accepted students must undergo a criminal history background check prior to entering the program and will be required to undergo facility-specific background checks while in the program. Students may be required to undergo drug screening. Information regarding the background checks can be found on the program's website and will be provided to students before fall nursing classes begin. Accepted students will also be required to complete by a specified deadline a CPR Health Care Provider course (adult/infant/child, one- and two-person, with AED; course must have been successfully completed prior to admission to nursing courses and maintained throughout the program). The CPR course must comply with the recently revised American Heart Association standards (compression, airway, breathing sequence rather than the previous airway, breathing, compression sequence). Information regarding required immunizations will be provided in the acceptance letter.

Internet and email access is an integral part of all nursing courses and access to a computer (at home or at the College) will be required on a daily basis. Nursing students attend classes at the BMCC campus in Pendleton and clinical practicum in northeastern Oregon and southeastern Washington and will need reliable transportation. See the program website and/or program information for progression policies.

Graduation Requirements

These requirements apply only to nursing students admitted to the program during the 2013-2014 academic year. The program of study, graduation requirements, and courses are under constant review and are subject to revision. Students contemplating admission in a later year may have different requirements and must obtain the advising guide or catalog for that year. If required courses (i.e., clinicals) are graded only on a pass/no pass basis, a grade of "P" for these courses indicate a student earned a "C" or better grade.

Students must complete all courses on this advising guide with a grade of "C" or better to continue in and complete the program, receive their degrees, and meet the educational requirements to apply to take the national licensure exam (NCLEX-RN). The OSBN screens all applicants for licensure and may deny licensure to or place on probation applicants with convictions for certain crimes. Licensure applicants with a history of chemical dependence will be required to have a drug and alcohol counselor assessment. Contact the OSBN (<http://www.osbn.state.or.us>) with any questions.

HEALTH SERVICES PATHWAY

Prerequisites/Required Preparatory Courses¹

BI231 ⁹ Anatomy & Physiology I	4
BI232 Anatomy & Physiology II	4
BI233 Anatomy & Physiology III	4
BI234 Microbiology	4
CH110 ² Chemistry (or higher)	4-5
MTH095 ⁹ Intermediate Algebra (or higher)	4-5
FN225 Nutrition	4
PSY201 ³ , PSY202, PSY203 General Psychology	6-8
or	
SOC204, SOC205 General Sociology	(6-8)
PSY237 Human Development	3-4
COM111 Fundamentals of Speech	3-4
or	
COM115 Intercultural Communication	(3-4)
WR123 English Composition	
or	8-9
WR227 ⁴ Technical Report Writing	(8-9)
Computer Literacy ⁵	0-4

¹Prerequisite/Preparatory Credits to be Eligible To Apply 30

All Prerequisite/Preparatory Credits to be Completed Before Admission to Nursing Courses, Minimum of: 48

First-Year Nursing Course Requirements

Fall Term

NRS110 Foundations of Nursing—Health Promotion	9
BI149 Human Genetics ⁶	3
Any lower division transfer elective	3
Total credits-1st Fall Term: 15	

Winter Term

NRS111 Foundations of Nursing in Chronic Illness I	6
NRS230 Clinical Pharmacology I	3
NRS232 Pathophysiology I	3
Any college-level (100 or 200 numbered) transferable humanities, social science or science electives ⁷	3-4
Total credits-1st Winter Term: 15-16	

Spring Term⁸

NRS112 Foundations of Nursing in Acute Care I	6
NRS231 Clinical Pharmacology II	3
NRS233 Pathophysiology II	3
Total credits-1st Spring Term: 12	

Second-Year Nursing Course Requirements

Fall Term

NRS221 Nursing in Chronic Illness II/End of Life	9
Any college-level (100 or 200 numbered) transferable humanities, social science or science electives ⁷	6
Total credits-2nd Fall Term: 15	

Winter Term

NRS222 Nursing in Acute Care II/ End of Life	9
Any college-level (100 or 200 numbered) transferable humanities, social science or science electives ⁷	6
Total credits-2nd Winter Term: 15	

Spring Term

NRS224 Integrative Practicum	9
Any college-level (100 or 200 numbered) transferable humanities, social science or science electives ⁷	3
Total credits-2nd Spring Term: 12	

²Prerequisite for BI231, Human Anatomy and Physiology I. MTH070 or higher required for most chemistry courses.

³PSY201 prerequisite for PSY237, Human Development.

⁴WR123 or WR227 must be completed by Year Two. Neither WR227 nor WR123 required if students have completed WR121 and WR122, 4 credits each (8 credits total, inclusive of research writing).

⁵Can be met by passing CS120, BA131, ED235, AGR111 or by taking BMCC's IC3 (computer literacy) exam and receiving a passing average score of 75% or higher.

⁶BI149, Human Genetics, can be taken prior to admission to the nursing program but is not required for admission.

⁷Students who plan to continue through to OHSU must be aware that to earn the bachelor's degree from OHSU, they must have two years of the same high school-level language, or two terms of college-level language, or pass a language proficiency examination. College-level foreign language (including American Sign Language) credits count toward degree requirements. A minimum of 9 credits of humanities is required for the OHSU degree. Students planning to transition to OHSU must have 132 credits of prerequisite and program required courses by the completion of the AAS degree in order to meet the 180 credit requirement by the completion of the Bachelor's Degree with a major in Nursing from OHSU. Students planning to earn a bachelor's degree are encouraged to complete MTS243 Probability and Statistics soon after the prerequisite math course.

⁸Student may earn AAS and take NCLEX exam or transfer to OHSU to complete BSN.

⁹Must be completed by end of fall term, 2012.

Courses required for the A.A.S. Nursing (courses in bold taken prior to admission to program):

BI149 Human Genetics	3
COM111 Fundamentals of Speech	4
or	
COM115 Intercultural Communication	(4)
MTH095 Intermediate Algebra (or higher)	5
PSY201 General Psychology	4
or	
PSY202 General Psychology	(4)
PSY237 Human Development	4
NRS110 Foundations of Nursing-Health Promotion	9
NRS111 Foundation of Nursing in Chronic Illness I	6
NRS112 Foundation of Nursing in Acute Care I	6
NRS221 Foundation of Nursing in Chronic Illness II/End of Life	9
NRS222 Foundation of Nursing in Acute Care II/End of Life	9
NRS224 Scope of Practice/Integrated Practicum	9
NRS230 Clinical Pharmacology I	3
NRS231 Clinical Pharmacology II	3
NRS232 Pathophysiological Processes I	3
NRS233 Pathophysiological Processes II	3
SOC204 General Sociology	4
or	
SOC205 General Sociology	(4)
WR121 English Composition	4
WR122** English Composition	4
Total Credits required for AAS Nursing: 92	

** English Composition series must include research component i.e.: WR121-WR123 or WR227 (if all 3 credit courses) OR WR121 and WR122 as 4 credit courses to include research component.

HUMAN RESOURCES PATHWAY

Criminal Justice: Corrections Career Pathways Certificate of Completion (CPCC)



Human Resources

Intended Program Outcomes:

This less than one-year program leading to a career pathways certificate of completion in corrections provides students with a well-rounded basis for interaction with corrections clients in a variety of correctional settings. Learning experiences in this program are designed to assist the student in realizing the following outcomes:

- Identify historical and philosophical evolution of theories explaining criminal and delinquent behavior.
- Identify the historical and philosophical evolution of law enforcement, courts, and correctional systems in the American criminal justice system.
- Describe and relate the constitutional rights and responsibilities of citizens, offenders, and victims as they apply to state, federal and procedural laws.
- Identify the characteristics of professional integrity and ethical standards for criminal justice professionals.
- Understand the legal responsibilities of law enforcement professionals as they relate to cultural diversity and establishing positive community relations.
- Demonstrate competence in core skill areas and in written and oral communication, problem-solving, and critical thinking.

Employment opportunities include correctional officer, work release counselor and corrections technician in private, local, state, or federal agencies.

CJ100 Introduction to Criminal Justice	3
CJ130 Correctional Systems and Practices	3
CJ200 Theories of Crime and Delinquency	3
CJ212 Criminal Investigation	3
CJ214 Criminal Justice Report Writing	3
CJ222 Procedural Law	3
CJ227 Ethics in Criminal Justice	3
CJ132 Probation & Parole: Systems & Practices	3
or	
CJ232 Correctional Casework Counseling	(3)
COM111 Fundamentals of Speech (or higher)	4
WR121 English Composition (or higher)	4
TOTAL CREDITS:	32

Note: All coursework must be completed with a grade of C or better.

(Pending State Approval)

Criminal Justice: Court Technician Career Pathway Certificate of Completion (CPCC)



Human Resources

Intended Program Outcomes:

This less than one-year program leading to a career pathways certificate of completion in court technician offers the student an opportunity to develop a foundational understanding of working in a legal and criminal justice setting. Learning experiences in this program are designed to assist the student in realizing the following outcomes:

- Identify historical and philosophical evolution of theories explaining criminal and delinquent behavior.
- Identify the historical and philosophical evolution of law enforcement, courts, and correctional systems in the American criminal justice system.
- Describe and relate the constitutional rights and responsibilities of citizens, offenders, and victims as they apply to state, federal and procedural laws.
- Identify the characteristics of professional integrity and ethical standards for criminal justice professionals.
- Demonstrate competence in core skill areas and in written and oral communication, problem-solving, and critical thinking.
- Use of appropriate legal terminology with written and oral accuracy.
- Ability to effectively use the computer to find information and create documents.

Successful completion of this certificate program will provide students with the skills and knowledge needed to qualify for an entry-level position in a local or state judicial system, private legal offices, and various criminal justice agencies.

CS120 Concepts of Computing	4
WR121 English Composition (or higher)	4
COM111 Fundamentals of Speech (or higher)	4
BT230 Legal Terminology I	3
BT232 Legal Terminology II	3
CJ227 Ethics in Criminal Justice 3	3
CJ222 Procedural Law	3
CJ200 Theories of Crime and Delinquency	3
CJ120 American Court Systems and Practices	3
CJ100 Introduction to Criminal Justice	3
TOTAL CREDITS:	33

Note: All coursework must be completed with a grade of C or better.

(Pending State Approval)

HUMAN RESOURCES PATHWAY

Criminal Justice: Law Enforcement: Career Pathway Certificate of Completion (CPCC)



Human Resources

Intended Program Outcomes:

This less than one-year program leading to a career pathways certificate of completion in law enforcement offers the student an opportunity to develop a foundational understanding of law enforcement, criminal investigation, criminology, and how the criminal justice system functions as a whole. Learning experiences in this program are designed to assist the student in realizing the following outcomes:

- Identify historical and philosophical evolution of theories explaining criminal and delinquent behavior.
- Identify the historical and philosophical evolution of law enforcement, courts, and correctional systems in the American criminal justice system.
- Describe and relate the constitutional rights and responsibilities of citizens, offenders, and victims as they apply to state, federal and procedural laws.
- Identify the characteristics of professional integrity and ethical standards for criminal justice professionals.
- Understand the legal responsibilities of law enforcement professionals as they relate to cultural diversity and establishing positive community relations.
- Demonstrate competence in core skill areas and in written and oral communication, problem-solving, and critical thinking.

Successful completion of this certificate program will provide students with the skills and knowledge needed to qualify for an entry-level position in private, local, state, or federal agencies or as a loss prevention specialist. Many departments require college course work or degrees in addition to civil service requirements, including a background investigation.

COM111 Fundamentals of Speech (or higher)	4
WR121 English Composition (or higher)	4
CJ227 Ethics in Criminal Justice	3
CJ222 Procedural Law	3
CJ220 Criminal Law	3
CJ214 Criminal Justice Report Writing	3
CJ212 Criminal Investigation	3
CJ210 Policy and Community	3
CJ200 Theories of Crime and Delinquency	3
CJ110 Police Systems and Practices	3
CJ100 Introduction to Criminal Justice	3
TOTAL CREDITS:	35

Note: All coursework must be completed with a grade of C or better.

(Pending State Approval)

A.A.S. – Criminal Justice



Human Resources

Intended Program Outcomes:

The coursework for this two-year program is designed to provide students with the knowledge and skills necessary for entry-level employment in the areas of law enforcement, courts, and adult or juvenile corrections. The competition for jobs in the field of criminal justice is intense; a college education is almost always a minimum requirement for the application process. The degree utilizes an interdisciplinary approach, including criminological, sociological, and psychological coursework. The learning experiences in this program are designed to assist the student in realizing the following outcomes:

- Identify historical and philosophical evolution of theories explaining criminal and delinquent behavior
- Identify the historical and philosophical evolution of law enforcement, courts, and correctional systems in the American criminal justice system
- Describe and relate the constitutional rights and responsibilities of citizens, offenders, and victims as they apply to state, federal and procedural laws.
- Identify the characteristics of professional integrity and ethical standards for criminal justice professionals
- Understand the legal responsibilities of criminal justice professionals as they relate to cultural diversity and establishing positive community relations
- Demonstrate competence in core skill areas and in written and oral communication, problem-solving, and critical thinking

TERM 1

CJ100 Introduction to Criminal Justice	3
WR121 English Composition	4
CJ101 Careers in Criminal Justice	3
BA104 Business Mathematics (or higher) or MTH095 Intermediate Algebra (or higher)	4 (5)
TERM 1 Total:	14

TERM 2

CJ110 Police Systems and Practices	3
CJ120 American Court Systems and Practices	3
GS111 Physical Science/Forensic Science or Science with Laboratory Courses	4 (4)
WR227 Technical Report Writing or WR122 English Composition	4 (4)
TERM 2 Total:	14

TERM 3

CJ132 Probation and Parole: Systems & Practices	3
COM111 Fundamentals of Speech (or higher)	4
CJ130 Correctional Systems and Practices	3
ANTH103 Introduction to Cultural Anthropology	4
CS120 Concepts of Computing	4
TERM 3 Total:	18

TERM 4

PSY201 General Psychology	4
SOC204 General Sociology	4
CJ Electives	3
CJ200 Theories of Crime and Delinquency	3
TERM 4 Total:	14

TERM 5

CJ201 Juvenile Justice	3
SOC205 General Sociology	4
CJ220 Criminal Law	3
CJ212 Criminal Investigation	3
PSY202 General Psychology	4
TERM 5 Total:	17

TERM 6

SOC213 Minorities	4
CJ214 Criminal Justice Report Writing	3
CJ227 Ethics in Criminal Justice	3
CJ222 Procedural Law	3
TERM 6 Total:	13
TOTAL CREDITS:	90

Note: All coursework must be completed with a grade of C or better.

HUMAN RESOURCES PATHWAY

Early Childhood Education Assistant (CPCC)



Human Resources

Intended Program Outcomes:

- Demonstrate knowledge of child development in a socio-cultural context.
- Apply developmentally appropriate practices (DAP) to meet the needs of diverse populations.
- Apply best practices in group management to optimize the potential for learning and social-emotional development.
- Practice ethical and legal standards, as well as professional attitudes and behavior.
- Apply best practices, observation and assessment to enhance learning and development.

ECE280 CWE ECE	4
ECE152 Creativity for Young Children	3
ECE100 Developmentally Appropriate Practice	3
ECE226 Child Development	3
ECE151 Guidance and Classroom Management	3

TOTAL CREDITS: 16

(Pending State Approval)

Early Childhood Education Certificate



Human Resources

Intended Program Outcomes:

- Demonstrate knowledge of child development in a socio-cultural context
- Apply developmentally appropriate practices (DAP) to meet the needs of diverse populations
- Apply best practices in group management to optimize the potential for learning and social-emotional development
- Practice ethical and legal standards, as well as professional attitudes and behavior
- Apply best practices, observation, and assessment to enhance learning and development.

ECE100 Developmentally Appropriate Practice	3
ECE111 Introduction to ECE Environments	3
ECE249 Inclusion of Children with Special Needs	3
ECE154 Literature and Literacy	3
ECE280 CWE ECE	2
Social Science Courses	4
ECE151 Guidance and Classroom Management	3
ECE150 Observation/Assessment and Recording	3
ECE101 Family and Community Relations	3
ECE240 Curriculum/Planning	3
ECE226 Child Development	3
WR060 Elements of the Essay (or higher)	3
ED157 Introduction to Mathematical Explorations	3
or	
MTH070 Elementary Algebra	(5)
ECE152 Creativity for Young Children	3
or	
ECE153 Music & Movement for Young Children	(3)
CTE Electives	3
or	
AAOT Electives	(4)
or	
ECE280 CWE ECE	(3)

TOTAL CREDITS: 45

A.A.S./Early Childhood Education



Human Resources

Intended Program Outcomes:

This two-year A.A.S. degree program in early childhood education (ECE) will prepare students to work with young children from birth through eight years of age in a variety of settings including child care centers, family child care settings, preschools, Head Start programs, school age programs, and home visiting and parent education programs. This program will prepare students with the requisite knowledge and skills in the following areas:

- Demonstrate knowledge of child development in a socio-cultural context
- Apply developmentally appropriate practices (DAP) to meet the needs of diverse populations
- Apply best practices in group management to optimize the potential for learning and social-emotional development
- Practice ethical and legal standards, as well as professional attitudes and behavior
- Apply best practices, observation, and assessment to enhance learning and development

This degree is based on the Guidelines for Preparation of Early Childhood Professionals from the National Association for the Education of Young Children (NAEYC), which qualifies the student to become, among other professional roles, a lead teacher in a child care facility licensed by the Oregon Child Care Division, a teacher in a Head Start program, and a home visitor in the human services field. Some courses in the program may not transfer to other institutions. Students intending to transfer should select electives that meet the A.A.O.T. requirements. It is strongly recommended that students seek advisor assistance prior to and throughout their BMCC educational experience.

The student is required to complete a criminal history check prior to enrollment in ECE 280: Cooperative Work Experience (CWE).

WR115 Introduction to College Writing (or higher)	4
Social Science Courses	8
ECE280 CWE ECE	3
Early Childhood Education AAS List 1	20
ECE249 Inclusion of Children with Special Needs	3
ECE100 Developmentally Appropriate Practice	3
COM100 Human Communications (or higher)	4
ECE226 Child Development	3
ECE240 Curriculum/Planning	3
ECE101 Family and Community Relations	3
ECE150 Observation/Assessment and Recording	3
ECE151 Guidance and Classroom Management	3
AAOT Electives	28
or	
CTE Electives	(28)
ED157 Introduction to Mathematical Explorations	3
or	
MTH070 Elementary Algebra (or higher)	(5)

TOTAL CREDITS: 91

HUMAN RESOURCES PATHWAY

English Language Development Certificate (less than one year)



Human Resources

Intended Program Outcomes:

- Demonstrate appropriate strategies and techniques to provide instructional support to students of diverse populations
- Demonstrate attitudes and behaviors that are appropriate in meeting the needs of diverse populations

ED280 CWE ED	2
ED250 Second Language Acquisition	2
ED251 Literacy Development for Second Language	3
ED252 Technology and Second Language Learners	2
ED255 Bilingual Education/ELD Strategies	3
ED254 Instructional Strategies for ELL Students	3

TOTAL CREDITS: 15

Paraeducator: Autism Certificate



Human Resources

Intended Program Outcomes:

Students who complete the (less than one year) paraeducator: autism certificate will be prepared to enter the K-12 school system successfully as a paraeducator with increased skills in recognition and appropriate strategies for dealing with autistic students; and will demonstrate the following outcomes:

- Demonstrate appropriate strategies and techniques to provide instructional support to students of diverse populations, including but not limited to students with special needs with special emphasis on autism, students from poverty, and ELL students
- Demonstrate attitudes and behaviors that are appropriate to meeting the needs of diverse populations
- Apply best practices in classroom management to optimize the potential for student learning
- Practice ethical and legal standards of conduct
- Apply technology effectively to support teaching learning
- Demonstrate competence in core skill area; written and oral communication, problem-solving, critical thinking, reading, and mathematics

The paraeducator: autism certificate, offers coursework designed for anyone interested in teaching and learning techniques or working as an educational assistant in the K-12 school system. The core curriculum offers instruction in basic teaching strategies, working with diverse, special needs populations, classroom management, and practicum experience. This curriculum incorporates courses specially designed for those working with autism. The curriculum is available through distance education courses. The paraeducator: autism certificate is embedded in the associate of applied science degree for paraeducators.

ED260 Overview of Autism Spectrum Disorders	3
ED261 Instructional Strategies for Autism Spectrum Disorders	3
ED262 Behavior Management for Autism Spectrum Disorders	3
ED263 Communication Strategies for Autism Spectrum Disorders	3
ED280 CWE ED	2
Education Electives	2
ED131 Instructional Strategies	3
ED169 Overview of Student with Special Needs	3
ED130 Classroom Management	3

TOTAL CREDITS: 25

Paraeducator - Elementary Educator (CPCC)



Human Resources

Intended Program Outcomes:

- Demonstrate appropriate strategies and techniques to provide instructional support to students of diverse populations, including but not limited to students with special needs, students from poverty, and English-language learner (ELL) students
- Demonstrate attitudes and behaviors that are appropriate to meeting the needs of diverse populations
- Apply best practices in classroom management to optimize the potential for student learning;
- Practice ethical and legal standards of conduct
- Apply technology effectively to support teaching learning

ED100 Introduction to Education	1
ED113 Instructional Strategies in Language Arts	3
ED200 Foundation of Education	3
ED229 Learning and Development	3
ED254 Instructional Strategies for ELL Students	3
ED258 Multicultural Education	3
ED280 Cooperative Work Experience-Education	1

TOTAL CREDITS: 17

HUMAN RESOURCES PATHWAY

Paraeducator Certificate



Human Resources

Intended Program Outcomes:

Students who complete this one-year certificate program will be prepared to enter the K-12 school system successfully as paraeducators and will demonstrate the following outcomes:

- Demonstrate appropriate strategies and techniques to provide instructional support to students of diverse populations, including but not limited to students with special needs, students from poverty, and ELL students
- Demonstrate attitudes and behaviors that are appropriate to meeting the needs of diverse populations
- Apply best practices in classroom management to optimize the potential for student learning
- Practice ethical and legal standards of conduct
- Apply technology effectively to support teaching and learning
- Demonstrate competence in the core skill area and in written and oral communication, problem-solving, critical thinking, reading, and mathematics

This curriculum is an Oregon Department of Education-approved statewide program that meets the requirements of the No Child Left Behind Federal Legislation for "Highly Qualified" status. The core curriculum offers instruction in; basic teaching strategies in language arts/math/science, working with diverse, special-needs populations, technology, classroom management; and practicum experience. In addition, general education courses in human relations, communication, and computation are incorporated. The curriculum is available through distance education and face-to-face courses. The paraeducator certificate also satisfies some of the program-specific course requirements for the paraeducator A.A.S. degree.

ED113 Instructional Strategies in Language Arts	3
ED130 Classroom Management	3
ED114 Instructional Strategies in Math/Science	3
ED100 Introduction to Education	1
ED235 Educational Technology	3
ED254 Instructional Strategies for ELL Students	3
ED258 Multicultural Education	3
ED229 Learning and Development	3
ED200 Foundation of Education	3
ED169 Overview of Student with Special Needs	3
ED131 Instructional Strategies	3
ED280 CWE ED	3
AAOT Electives	4
WR115 Introduction to College Writing (or higher)	4
ED157 Introduction to Mathematical Explorations	3
or	
MTH070 Elementary Algebra (or higher)	(5)
TOTAL CREDITS: 45	

A.A.S./Paraeducator



Human Resources

Intended Program Outcomes:

Students who complete this degree program will be prepared to enter the K-12 school system successfully as a paraeducator and will demonstrate the following outcomes:

- Demonstrate appropriate strategies and techniques to provide instructional support to students of diverse populations, including but not limited to students with special needs, students from poverty, and ELL students
- Demonstrate attitudes and behaviors that are appropriate to meeting the needs of diverse populations
- Apply best practices in classroom management to optimize the potential for student learning
- Practice ethical and legal standards of conduct
- Apply technology effectively to support teaching and learning
- Demonstrate competence in core skill area and in written and oral communication, problem-solving, critical thinking, reading, and mathematics

COM100 Human Communications (or higher)	4
ED100 Introduction to Education	1
ED113 Instructional Strategies in Language Arts	3
ED114 Instructional Strategies in Math/Science	3
ED130 Classroom Management	3
ED258 Multicultural Education	3
ED254 Instructional Strategies for ELL Students	3
ED235 Educational Technology	3
ED131 Instructional Strategies	3
ED169 Overview of Student with Special Needs	3
ED200 Foundation of Education	3
ED229 Learning and Development	3
WR121 English Composition (or higher)	4
WR115 Introduction to College Writing (or higher)	4
Science with Laboratory Courses	8
Social Science Courses	8
Health and Fitness Courses	3
Arts & Letters (Humanities)	8
ED280 CWE ED	3
CTE Electives	14
or	
AAOT Electives	(14)
ED157 Introduction to Mathematical Explorations	3
or	
MTH070 Elementary Algebra (or higher)	(5)
TOTAL CREDITS: 90	

INDUSTRIAL & ENGINEERING SYSTEMS PATHWAY

A.A.S./Civil Engineering Technology



Industrial and Engineering Systems

Intended Program Outcomes:

This two-year program will prepare the student either for transfer to a four-year degree program in construction management or to be effective as a technician on a civil engineering team in the workplace in the following areas:

- Concrete design
- Applied structural design methods
- Applied technology (production software, CAD, GIS)
- Communication skills (writing, presentation techniques)
- Property surveying
- Professional skills (estimating, proposal development)

Students with appropriate math/science aptitude can complete the civil engineering/construction technology curriculum in two years at BMCC. Students desiring to transfer to four-year engineering programs are encouraged to see an advisor for appropriate coursework.

TERM 1

CET111 Introduction to Engineering Technology	3
CET145 Engineering Graphics	3
WR115 Introduction to College Writing (or higher)	4
Human Relations selection	3

TERM 1 Total: 13

TERM 2

MTH084 Technical Math for Civil Engineer Technicians	2
CET112 Computer Aided Drafting	3
CET162 Engineering Materials	3
CET215 Contract Documents	4
BA131 Introduction to Business Computing	4
or	
CS120 Concepts of Computing	(4)

TERM 2 Total: 16

TERM 3

CET114 Introduction to Geographic Info Systems	3
COM111 Fundamentals of Speech	4
SUR161 Plane Surveying	5

TERM 3 Total: 12

TERM 4

CET261 Hydraulics	4
MTH112 Elementary Functions (or higher)	5
PHY201 General Physics	5
SUR162 Surveying and Mapping	5

TERM 4 Total: 19

TERM 5

CET265 Hydraulics II	4
CET222 Concrete Practices	4
CET231 Structures	4
SUR166 Highway Fundamentals	3

TERM 5 Total: 15

TERM 6

CET223 Soil Mechanics	3
CET235 Structures	4
CET251 Estimating Construction Costs	4
WR227 Technical Report Writing	4

TERM 6 Total: 15

TOTAL CREDITS: 90

Diesel Technology: Technician Assistant Career Pathways Certificate of Completion C.P.C.C.



Industrial and Engineering Systems

Intended Program Outcomes:

- Learn to explain and demonstrate safe and efficient shop practices; types and use of personal protective equipment, and proper use of shop tools and equipment. Complete forklift training and obtain certificate
- Learn basic electrical theory, principles of electrical circuitry, component construction and operation, and the use of a digital multi-meter
- Diagnose and repair steering and suspension systems, and perform steering, suspension, and chassis alignment
- Understand the design, construction, and operation of the oil fueled, compression ignition engine
- Understand the principles of operation of power train components and application of clutches, drive shafts, manual transmissions, and differential drive axles
- Understand the principles of operation of compressed air systems and air brake components. Study electric, hydraulic, and mechanical braking system operation
- Practice the use of oxyacetylene and AC/DC electric welding equipment to develop skills in brazing, welding, and cutting of various types of material
- Develop basic typing and keyboarding skills

DSL152 Manual Drive Trains I	3
DSL161 Diesel Engine Theory	4
DSL191 Electrical Systems I	4
DSL181 Shop Practices	3
DSL151 Heavy Duty Brakes	3
DSL141 Heavy Duty Steering & Suspension	4
WLD111 Basic Gas & Arc Welding	3
BT120 Computer Keyboarding (or higher)	2

TOTAL CREDITS: 26

Diesel and welding required courses must be completed with a C or better.



INDUSTRIAL & ENGINEERING SYSTEMS PATHWAY

A.A.S./Diesel Technology



Industrial and Engineering Systems

Intended Program Outcomes:

This two-year A.A.S. degree will prepare graduates with the necessary skills and knowledge to enter the diesel technology field with the following capabilities:

- Service, diagnose and repair diesel engines
- Service and repair suspension and steering
- Service and replace brakes
- Diagnose and repair electrical/electronic systems
- Safe shop practices
- Written and oral communication skills in dealing with customer service and report writing
- Ability to use math in problem solving
- Ability to effectively use the computer to find information, create documents and send correspondence
- Understand and service basic hydraulic systems
- Ability to perform basic arc and oxy-acetylene welding

This program is designed to prepare graduates to meet job entry requirements for a variety of jobs in the field. The curriculum provides classroom work and practical experience in the lab. In addition to the heavy truck focus, this program offers training in agricultural and heavy equipment. **Diesel and welding required courses must be completed with a C or better.** Students must begin this program Fall term.

WR065 Introduction to Technical Writing (or higher)	3
COM100 Human Communications (or higher)	4
Human Relations	3
BT120 Computer Keyboarding (or higher)	2
WLD111 Basic Gas & Arc Welding	3
DSL141 Heavy Duty Steering & Suspension	4
DSL151 Heavy Duty Brakes	3
DSL181 Shop Practices	3
DSL191 Electrical Systems I	4
DSL161 Diesel Engine Theory	4
DSL152 Manual Drive Trains I	3
DSL192 Electrical Systems II	4
MTH042 Technical Mathematics (or higher)	4
DSL262 Diesel Engine Repair II	4
DSL162 Diesel Engine Repair I	4
DSL153 Manual Drive Trains II	3
DSL193 Electrical Systems III	4
DSL251 Heavy Duty Brakes II	3
DSL184 Applied Fluid Mechanics	4
DSL196 Electronic Diagnostics & Emission Controls	3
DSL176 Mobile Air-Conditioning & Heating	3
DSL175 Heavy Equipment	3
DSL280 CWE DIESEL	6
DSL200 Pre-Employment Seminar	1
DSL263 Advanced Engine Technology	4
DSL275 Heavy Duty Equipment II	3
BA131 Introduction to Business Computing	4
or	
CS120 Concepts of Computing	(4)
TOTAL CREDITS: 93	

Drafting Technology: Survey Technician Career Pathways Certificate of Completion C.P.C.C.



Industrial and Engineering Systems

Intended Program Outcomes:

This less than one-year program will prepare the graduates to be effective as a technician on a survey crew in the workplace in the following areas:

- Applied Technology (production software, CAD, GIS)
- Communication Skills (writing, presentation techniques)
- Property Surveying
- Roadway and drainage design

Diesel and welding required courses must be completed with a C or better.

MTH070 Elementary Algebra (or higher)	5
SUR162 Surveying and Mapping	5
SUR161 Plane Surveying	5
CET145 Engineering Graphics	3
CET113 Advanced Computer Aided Drafting	3
CET114 Introduction to Geographic Info Systems	3
CET112 Computer Aided Drafting	3
WR065 Introduction to Technical Writing	3
or	
WR227 Technical Report Writing	(4)
or	
WR115 Introduction to College Writing	(4)
or	
WR121 English Composition	(4)
TOTAL CREDITS: 30	

Welding Certificate (less than one year)



Industrial and Engineering Systems

Intended Program Outcomes:

This 12-credit-hour certificate of completion program is designed to prepare students for entry-level jobs in welding and related trades and to prepare students to pursue a certificate of completion or A.A.S. degree in welding technology from another educational institution. The program consists of the following courses:

WLD253 Welding Practices for Certification	3
WLD112 Advanced Arc Welding	3
AGM221 Metals and Welding	3
or	
WLD111 Basic Gas & Arc Welding	(3)
WLD256 Pipe Welding for Certification	3
or	
WLD221 TIG Welding	(3)
TOTAL CREDITS: 12	

INDUSTRIAL & ENGINEERING SYSTEMS PATHWAY

A.A.S./Drafting Technology



Industrial and Engineering Systems

Intended Program Outcomes:

This two-year A.A.S. degree program in drafting technology will prepare the student to be effective as a drafting/CAD (computer-aided drafting) technician in the workplace in the following areas:

- Applied structural detailing
- Applied construction monitoring
- Applied technology (production software, CAD, geographical information systems/GIS)
- Communication skills (writing, presentation techniques)
- Property surveying
- Contract documents, estimating

Students with appropriate math and visualization skills and good attention to detail can complete the drafting technology curriculum in two years at BMCC.

CET280 CWE CET	8
MTH070 Elementary Algebra (or higher)	5
CET205 Structural Drafting	3
CET263 3-D Computer Aided Drafting	3
CET251 Estimating Construction Costs	4
CET215 Contract Documents	4
CET223 Soil Mechanics	3
CET222 Concrete Practices	4
CET145 Engineering Graphics	3
CET114 Introduction to Geographic Info Systems	3
CET113 Advanced Computer Aided Drafting	3
CET112 Computer Aided Drafting	3
CET111 Introduction to Engineering Technology	3
COM100 Human Communications (or higher)	4
SUR162 Surveying and Mapping	5
SUR166 Highway Fundamentals	3
SUR167 Surveying Seminar	3
WR060 Elements of the Essay (or higher)	3
SUR161 Plane Surveying	5
GS104 Physical Science/Physics	4
CET152 Materials of Construction	2
or	
CET162 Engineering Materials	(3)
Science Electives	4
or	
GEOG101 Physical Geography	(4)
Social Science Courses	4
or	
GEOG206 Geography of Oregon	(4)
BA131 Introduction to Business Computing	4
or	
CS120 Concepts of Computing	(4)
WR065 Introduction to Technical Writing	3
or	
WR227 Technical Report Writing	(4)

TOTAL CREDITS: 93

Green Technician Certificate



Industrial and Engineering Systems

Intended Program Outcomes:

The primary intended outcome of the green technician certificate program is placement in a variety of entry-level positions across a number of industry sectors, and building an in-demand set of skills that will allow program graduates to advance rapidly in a variety of current and emerging occupational areas across Oregon's rural communities.

Individuals who complete the green technician certificate will:

- Be multi-skill systems thinkers and problem solvers
- Be prepared for a broad array of green occupations across a variety of diverse industries
- Have a fundamental understanding of sustainability, green technologies, process improvements, elimination of waste, and an overview of various careers in green technology,
- Be able to demonstrate the applied reading and workplace math skills needed on -the-job
- Possess workplace skills that employers need: critical thinking, problem solving, team work, etc.
- Possess a unique set of entry-level electrical, mechanical, and heating/cooling systems skills
- Have the skills and ability to adjust to rapidly changing technology

GT101 Introduction to Industrial Sustainability	3
GT102 Green Industrial Safety	2
GT103 Mechanical Systems	3
GT104 Electrical Systems Troubleshooting I	3
GT106 Introduction to Green Technologies	2
GT107 Electrical Systems Troubleshooting II*	3
GT108 Building Systems	2
GT109 HVACR Systems Operations	3
GT110 Workplace Communications	3
GT111 Preventive Maintenance/Energy Conservation	2
GT112 Control Systems	3
GT113 Fluid Power	3
GT114 Local Applications/Alternative Energy	3
GT115 Human Relations/Customer Service	3
WR115 Introduction to College Writing (or higher)	4
GT105 Workplace Math/Applied Math	4
or	
MTH052 Intro to Algebra for the Trades (or higher)	(4)

TOTAL CREDITS: 46

Professional Truck Driver (less than one year)



Industrial and Engineering Systems

Intended Program Outcomes:

This limited-entry one-year program will prepare the student with the knowledge and hands-on experience necessary to be employable as an entry level tractor-trailer driver. Upon completion of this program, students will:

- Have the knowledge and skills necessary to pass the State/Federal Class A, Commercial Driver's License Road Test
- Be appropriately proficient in communication skills (writing, presentation techniques)
- Have the necessary skills for effective customer service

TTL280 Transportation & Logistics Cooperative Work Experience	6
TTL101 Introduction to Transportation & Logistics	4
TTL121 Practical Applications in Transportation & Logistics	6
TTL141 Transportation Customer Service Skills	3

TOTAL CREDITS: 19

INDUSTRIAL & ENGINEERING SYSTEMS PATHWAY - APPRENTICESHIP

Construction Trades, General Apprenticeship-Trade Worker Apprenticeship Technologies S.C.P.C.



Industrial and Engineering Systems

Intended Program Outcomes:

- Complete a minimum of 6000-8000 hours State of Oregon-approved on-the-job training (OJT).
- Repair, install, and maintain a variety of building construction projects using trade specific tools and techniques in compliance with building codes and OSHA regulations

TERM 1

APR110A Plumbing Apprenticeship Fundamentals	4
APR110B Plumbing Apprenticeship Math & Basic Installations	4
APR110C Plumbing Apprenticeship Print Reading	4
APR110D Plumbing Apprenticeship Installation	4
APR110E Plumbing Apprenticeship Occupancy	4
APR110F Plumbing Apprenticeship Advanced Waste System	4
TOTAL CREDITS:	24

Construction Trades, General Apprenticeship***Construction Trades General Apprenticeship S.C.P.C.



Industrial and Engineering Systems

(Limited-Entry Program-Journeyman's Card Required)

Intended Program Outcomes:

- Complete a minimum of 6000 to 8000 hours State of Oregon-approved on-the-job training (OJT)
- Repair, install, and maintain a variety of building construction projects using trade specific tools and techniques in compliance with building codes and OSHA regulations
- Seventy-five per cent of applicants have documented trade-specific skills listed on the Construction Trades, General Apprenticeship Outcomes Assessment Tool
- Complete required related training with a grade C or better

6000-8000-Hr BOLI-ATD Trades: Asbestos Removal, Carpenter, HVAC/R, Interior/Exterior Finisher, Painter, Pile Driver, Plumber, Scaffold Erector, and Sheet Metal.

Plumbing Apprentice List	48
Human Relations	3
WR060 Elements of the Essay (or higher)	3
or	
COM100 Human Communications (or higher)	(4)
MTH025 Pre-Algebra (or higher)	4
or	
BA131 Introduction to Business Computing	(4)
or	
CS120 Concepts of Computing	(4)
TOTAL CREDITS:	58

A.A.S./Construction Trades, General Apprenticeship



Industrial and Engineering Systems

(Limited-Entry Program-Journeyman's Card Required)

Intended Program Outcomes:

- Complete a minimum of 6000-8000 hours State of Oregon-approved on-the-job training (OJT)
- Repair, install and maintain a variety of building construction projects using trade specific tools and techniques in compliance with building codes and OSHA regulations
- Seventy-five percent of applicants have documented trade-specific skills listed on the Construction Trades, General Apprenticeship Outcomes Assessment Tool
- Complete required related training with a grade C or better

6000-8000-Hr BOLI-ATD Trades: Asbestos Removal, Carpenter, HVAC/R, Interior/Exterior Finisher, Painter, Pile Driver, Plumber, Scaffold Erector, and Sheet Metal.

COM100 Human Communications (or higher)	4
WR060 Elements of the Essay (or higher)	3
Human Relations	6
Journey Credit for Prior Certification	20
Plumbing Apprentice List	48
MTH070 Elementary Algebra (or higher)	5
CS120 Concepts of Computing	4
or	
BA131 Introduction to Business Computing	(4)
TOTAL CREDITS:	90

INDUSTRIAL & ENGINEERING SYSTEMS PATHWAY - APPRENTICESHIP

Electrician Apprenticeship Technologies-Trade Worker Apprenticeship Technologies: S.C.P.C.



Industrial and Engineering Systems

Intended Program Outcomes:

- Complete 6000-8000 hours State of Oregon-approved on-the-job-training. Apply theory to electrical wiring
- Repair & install electrical wire devices according to licensure regulations to meet NEC and OSC for Inside Electrician, Limited Energy Technician-License A, Limited Manufacturing Plant Electrician, Sign Assembler/Fabricator, Sign Maker/Erector, and Stationary Engineer

APR112A Inside Electrical Apprenticeship Fundamentals	4
APR112B Inside Electrical Apprenticeship AC/DC Circuits	4
APR112C Inside Electrical Apprenticeship Measurements	4
APR112D Inside Electrical Apprenticeship Theory	4
APR112E Inside Electrical Apprenticeship Wiring and Print Reading	4
APR112F Inside Electrical Apprenticeship Installation	4
or	
APR111A LMPE Apprenticeship Fundamentals	(4)
APR111B LMPE Apprenticeship AC/DC Circuits	4
APR111C LMPE Apprenticeship Measurement	4
APR111D LMPE Apprenticeship Theory	4
APR111E LMPE Apprenticeship Wiring and Print Reading	4
APR111F LMPE Apprenticeship Installation	4

TOTAL CREDITS: 24

Electrical Apprenticeship Technologies***Limited Electrician Technologies Certificate S.C.C.



Industrial and Engineering Systems

(Limited-Entry Program-Journeyman's Card Required)

Intended Program Outcomes:

- Complete 4000 hours State of Oregon-approved on-the-job-training (OJT)
- Repair or install electrical wire devices according to limited licensure regulations to meet NEC and OSC code for limited energy technician-license B, limited maintenance electrician, limited renewable energy technician, and limited residential electrician

4000 Hour BOLI-ATD Trades: Limited Energy Technician-license B, Limited Maintenance Electrician, Limited Renewable Energy Technician, and Limited Residential Electrician.

APR115A LME Apprenticeship Fundamentals/Theory	4
APR115B LME Apprenticeship AC/DC circuits	4
APR115C LME Measurement and Blueprint Reading	4
APR215D LME Apprenticeship Safety and Code	4
APR215E LME Apprenticeship Motors and Controls	4
APR215F LME Apprenticeship Code and Test	4

TOTAL CREDITS: 24

Electrician Apprenticeship Technologies***Electrician Apprenticeship Technologies Certificate S.C.C.



Industrial and Engineering Systems

(Limited-Entry Program-Journeyman's Card Required)

Intended Program Outcomes:

- Complete a minimum of 6000 to 8000 hours State of Oregon-approved on-the-job training (OJT)
- Repair, install, and maintain a variety of building construction projects using trade specific tools and techniques in compliance with building codes and OSHA regulations
- Seventy-five per cent of applicants have documented trade-specific skills listed on the Construction Trades, General Apprenticeship Outcomes Assessment Tool
- Complete required related training with a grade C or better

6000 Hour BOLI-ATD Trades: Limited Energy Technician-license A and Sign Maker/Fabricator.

8000 Hour BOLI-ATD Trades: Inside Electrician, Manufacturing Plant Electrician, Sign Assembler/Fabricator, Sign Maker/Erector and Stationary Engineer.

Human Relations	3
Inside Electrician	48
or	
LMPE List	(48)
CS120 Concepts of Computing	4
or	
BA131 Introduction to Business Computing	(4)
or	
MTH025 Pre-Algebra (or higher)	(4)
WR060 Elements of the Essay (or higher)	3
or	
COM100 Human Communications (or higher)	(4)

TOTAL CREDITS: 58

INDUSTRIAL & ENGINEERING SYSTEMS PATHWAY - APPRENTICESHIP

A.A.S./Electrician Apprenticeship Technologies



Industrial and Engineering Systems

(Limited-Entry Program-Journeyman's Card Required)

Intended Program Outcomes (6000-8000 hours):

- Complete 6000-8000 hours State of Oregon-approved on-the-job-training. Apply theory to electrical wiring
- Repair & install electrical wire devices according to licensure regulations to meet NEC and OSC for inside electrician, limited energy technician-license A, limited manufacturing plant electrician, sign assembler/fabricator, sign maker/erector, and stationary engineer
- Seventy-five percent of applicants have documented trade-specific skills listed on the Electrician Apprenticeship Trades Outcomes Assessment Tool
- Complete all required related-training with a grade of C or better

6000 Hour BOLI-ATD Trades: Limited Energy Technician-license A and Sign Maker/Fabricator.

8000 Hour BOLI-ATD Trades: Inside Electrician, Manufacturing Plant Electrician, Sign Assembler/Fabricator, Sign Maker/Erector, and Stationary Engineer. At least 90 credit hours of course work must be satisfactorily completed in order to receive this degree.

Intended Program Outcomes (4000 hours):

- Complete 4000 hours State of Oregon-approved on-the-job training (OJT)
- Repair or install electrical wire devices according to limited licensure regulations to meet NEC and OSC code for limited energy technician-license B, limited maintenance electrician, limited renewable energy technician, and limited residential electrician

4000 Hour BOLI-ATD Trades: Limited Energy Technician-license B, Limited Maintenance Electrician, Limited Renewable Energy Technician and Limited Residential Electrician. At least 90 credit hours of course work must be satisfactorily completed in order to receive this degree.

WR060 Elements of the Essay (or higher)	3
COM100 Human Communications (or higher)	4
MTH070 Elementary Algebra (or higher)	5
Human Relations	6
Journey Credit for Prior Certification	20
BA131 Introduction to Business Computing	4
or	
CS120 Concepts of Computing	(4)
LME Path includes 24 LME cr. + 24 electives (no more than 12 CT elec.)	48
or	
Inside Electrician	(48)
or	
LMPE List	(48)

TOTAL CREDITS: 90

Industrial Mechanics and Maintenance Technology Apprenticeship: Mechanical Maintenance Apprenticeship Certificate S.C.C.



Industrial and Engineering Systems

(Limited-Entry Program-Journeyman's Card Required)

Intended Program Outcomes:

- Complete 4000 hours State of Oregon-approved on-the-job-training (OJT)
- Repair or install electrical wire devices according to limited licensure regulations to meet NEC and OSC code for limited energy technician-license B, limited maintenance electrician, limited renewable energy technician, and limited residential electrician

4000 Hour BOLI-ATD Trades: Limited Energy Technician-license B, Limited Maintenance Electrician, Limited Renewable Energy Technician, and Limited Residential Electrician.

APR114A PLC Apprenticeship Hardware/Number Systems	4
APR114B PLC Apprenticeship Programming Fundamentals	4
APR114C PLC Apprenticeship Timers, Counters, Controls	4
APR214D PLC Apprenticeship Operation	4
APR214E PLC Apprenticeship Troubleshooting	4
APR214F PLC Apprenticeship Practical Applications	4

TOTAL CREDITS: 24

Industrial Mechanics & Maintenance Technology Apprenticeship-Trade Worker Apprenticeship Tech S.C.P.C.



Industrial and Engineering Systems

Intended Program Outcomes:

- Complete a minimum of 8000 hours State of Oregon approved on-the Job Training (OJT)
- Repair, install, and maintain a variety of industrial equipment using trade specific tools and techniques in compliance with state regulations

APR117A IMM APP. Blueprint Reading & Schematics	3
APR117B IMM APP. Industrial Math/Measurement	3
APR117C IMM APR Metals in the Plant	1
APR117D IMM APR Nonmetals in the Plant	1
APR117E IMM APR Hand Tools	1
APR117F IMM APR Portable Power Tools	1
APR117G IMM APR Industrial Safety & Health	1
APR117H IMM APR Troubleshooting Skills	1
APR117I IMM APR Industrial Rigging Principles & Practices	1
APR117J IMM APR Equipment Installation	1
APR117K IMM APR Basic Mechanics	1
APR117L IMM APR Lubricants and Lubrication	1
APR117M IMM APR Power Transmission Equipment	1
APR117N IMM APR Bearings	1
APR117O IMM APR Pumps	1
APR117P IMM APR Piping Systems	1
APR117Q IMM APR Basic Hydraulics	1
APR117R IMM APR Hydraulic Troubleshooting	1
APR117S IMM APR Basic Pneumatics	1
APR117T IMM APR Pneumatic	1
APR117U IMM APR Chemical Hazard	1
APR117V IMM APR Bulk Handling Conveyors	1

TOTAL CREDITS: 26

INDUSTRIAL & ENGINEERING SYSTEMS PATHWAY - APPRENTICESHIP

Industrial Mechanics and Maintenance Technology Apprenticeship ***Industrial Mechanics and Maintenance Technology Apprenticeship Certificate S.C.C.1.



Industrial and Engineering Systems

(Limited-Entry Program-Journeyman's Card Required)

Intended Program Outcomes:

- Complete a minimum of 4000 hours State of Oregon approved on-the job training (OJT)
- Repair, install and maintain a variety of industrial equipment using trade specific tools and techniques in compliance with state regulations
- Seventy-five percent of applicants have documented trade-specific skills listed on the Industrial Mechanics and Maintenance Technology Apprenticeship Trades Outcomes Assessment Tool
- Complete required related training with a grade C or better

4000-Hour BOLI-ATD Trades: Air Frame and Power Plant Technician, Boiler Operator and Programmable Logic Controller

Industrial Maintenance Mechanic	48
Human Relations	3
WR060 Elements of the Essay (or higher)	3
or	
COM100 Human Communications (or higher)	(4)
MTH025 Pre-Algebra (or higher)	4
or	
BA131 Introduction to Business Computing	(4)
or	
CS120 Concepts of Computing	(4)
TOTAL CREDITS:	58

A.A.S./Industrial Mechanics and Maintenance Technology Apprenticeship



Industrial and Engineering Systems

(Limited-Entry Program-Journeyman's Card Required)

Intended Program Outcomes:

- Complete a minimum of 4000 hours State of Oregon approved on-the job training (OJT)
- Repair, install and maintain a variety of industrial equipment using trade specific tools and techniques in compliance with state regulations

4000-Hour BOLI-ATD Trades: Air Frame and Power Plant Technicians, Boiler Operator and Programmable Logic Controller

8000-Hr BOLI-ATD Trades: Boiler/Turbine Operator, Die Cast Mold, Heat and Frost Insulator, Industrial Mobile Mechanic, Instrument Technician, Machinist, Millwright, Motor Winder,

MTH070 Elementary Algebra (or higher)	5
Journey Credit for Prior Certification	20
Human Relations	6
COM100 Human Communications (or higher)	4
WR060 Elements of the Essay (or higher)	3
CS120 Concepts of Computing	4
or	
BA131 Introduction to Business Computing	(4)
Industrial Maintenance Mechanic	48
or	
PLC Path includes 24 PLC cr. + 24 electives (no more than 12 CT elec.)	(48)
TOTAL CREDITS:	90



Transfer Course List

Discipline Studies

Arts and Letters (Humanities)

Art	<i>Credits</i>
ART101 - Introduction to Visual Arts	4
ART102 - Introduction to Visual Arts	4
ART103 - Introduction to Visual Arts	4
ART115 - Basic Design	4
ART116 - Basic Design	4
ART117 - Basic Design	4
ART131 - Beginning Drawing	4
ART132 - Beginning Drawing	4
ART133 - Beginning Drawing	4
ART154 - Beginning Ceramics	4
ART155 - Beginning Ceramics	4
ART156 - Beginning Ceramics	4
ART184 - Beginning Watercolor	4
ART185 - Watercolor	4
ART186 - Watercolor	4
ART204 - History of Western Art	4
ART205 - History of Western Art	4
ART231 - Intermediate Drawing	4
ART232 - Intermediate Drawing	4
ART233 - Intermediate Drawing	4
ART254 - Intermediate Ceramics	4
ART255 - Intermediate Ceramics	4
ART256 - Intermediate Ceramics	4
ART261 - Beginning Photography	4
ART262 - Digital Photo Imaging	4
ART263 - Beginning Photography	4
ART264 - Intermediate Photography	4
ART265 - Intermediate Photography	4
ART266 - Intermediate Photography	4
ART276 - Beginning Sculpture	4
ART277 - Beginning Sculpture	4
ART278 - Beginning Sculpture	4
ART281 - Beginning Painting	4
ART282 - Beginning Painting	4
ART283 - Beginning Painting	4
ART284 - Intermediate Painting	4
ART285 - Intermediate Painting	4
ART286 - Intermediate Painting	4
ART291 - Intermediate Sculpture	4
ART292 - Intermediate Sculpture	4
ART293 - Intermediate Sculpture	4
Communication:	<i>Credits</i>
COM111 - Fundamentals of Speech	4
COM112 - Fundamentals of Speech	4
~COM115 - Intercultural Communication	4
English	<i>Credits</i>
ENG104 - Introduction to Literature	4

ENG105 - Introduction to Literature	4
ENG106 - Introduction to Literature	4
~ENG107 - World Literature	4
~ENG108 - World Literature	4
~ENG109 - World Literature	4
ENG197 - Film as Literature	4
ENG201 - Shakespeare	4
ENG202 - Shakespeare	4
ENG203 - Shakespeare	4
ENG204 - Survey of English Literature	4
ENG205 - Survey of English Literature	4
ENG206 - Survey of English Literature	4
~ENG253 - Survey of American Literature	4
ENG254 - Survey of American Literature	4
ENG255 - Survey of American Literature	4
~ENG260 - Introduction to Women Writers	4
ENG263 - Detective Fiction	4
ENG264 - Detective Fiction	4
ENG269 - Nature Literature	4
PHL101 - Introduction to Philosophy	4
PHL102 - Introduction to Philosophy	4
WR121 - English Composition	4
WR122 - English Composition	4
WR227 - Technical Report Writing	4
WR241 - Introduction to Imaginative Writing	4
WR242 - Introduction to Imaginative Writing	4
WR243 - Introduction to Imaginative Writing	4

Foreign Languages	<i>Credits</i>
SPAN201 - Second-Year Spanish	4
SPAN202 - Second-Year Spanish	4
SPAN203 - Second-Year Spanish	4

Music	<i>Credits</i>
MUS205 - Introduction to Jazz History	4
MUS206 - Introduction to History of Rock Music	4
MUS207 - History of Folk Music	4

Theatre	<i>Credits</i>
TA101 - Introduction to the Theatre	4
TA141 - Fundamentals of Acting Techniques	4
TA142 - Fundamentals of Acting Techniques	4
TA143 - Fundamentals of Acting Techniques	4
TA241 - Intermediate Acting Techniques	4
TA242 - Intermediate Acting Techniques	4
TA243 - Intermediate Acting Techniques	4

Social Science

Social Science	<i>Credits</i>
ANTH101 - Introduction to Physical Anthropology	4
ANTH102 - Introduction to Archaeology and Prehistory	4
~ANTH103 - Introduction to Cultural Anthropology	4
EC201 - Principles of Microeconomic Theory with Applications	4
EC202 - Principles of Macroeconomic Theory with Applications	4
~GEOG103 - Human Geography	4
~GEOG120 - World/Regional Geography	4
GEOG206 - Geography of Oregon	4
~HST201 - History of the United States	4
~HST202 - History of the United States	4
~HST203 - History of the United States	4
PS201 - American Government and Politics	4
PS202 - American Government and Politics	4
PS203 - American Government/State and Local	4
PSY201 - General Psychology	4
PSY202 - General Psychology	4
PSY237 - Human Development	4
~SOC204 - General Sociology	4
~SOC205 - General Sociology/Institutions and Social Change	4
~SOC213 - Minorities	4
~SOC217 - Family and Society	4

Science/Mathematics/Computer Science

+ - Lab Science Course

Math/Computer Science	<i>Credits</i>
@CS120 - Concepts of Computing	4
CS133B - Programming with Visual Basic	4
CS133U - Programming with C++	4
CS161 - Computer Science	4
CS162 - Computer Science	4
CS195 - Web Development	4
CS260 - Data Structures	4
CS295 - Web Development	4
MTH105 - Introduction to Contemporary Mathematics	4
MTH111 - College Algebra	5
MTH112 - Elementary Functions	5
MTH211 - Foundations of Elementary Mathematics	4
MTH212 - Foundations of Elementary Mathematics	4
MTH213 - Foundations of Elementary Mathematics	4
MTH231 - Discrete Mathematics	4

Symbols: @ - Computer Literacy ~ - Cultural Awareness + - Lab Science

Transfer Course List

MTH241 - Calculus for Management/Social Science	4
MTH243 - Introduction to Probability and Statistics	4
MTH251 - Calculus	4
MTH252 - Calculus	4
MTH253 - Calculus	4
MTH254 - Vector Calculus	4
MTH256 - Differential Equations	4
MTH261 - Linear Algebra	4
Science	<i>Credits</i>
+BI101 - General Biology	4
+BI102 - General Biology	4
+BI103 - General Biology	4
+BI124 - Global Ecology and Conservation Biology	4
BI149 - Human Genetics	3
+BI162 - Selected Topics in Natural History	4
+BI163 - Natural History of Oregon	4
+BI211 - General Biology	5
+BI212 - General Biology	5
+BI213 - General Biology	5
+BI231 - Human Anatomy and Physiology	4
+BI232 - Human Anatomy and Physiology	4
+BI233 - Human Anatomy and Physiology	4
+BI234 - Microbiology	4
+BOT221 - Systematic Botany	4
+CH104 - Introductory Chemistry	5
+CH105 - Introductory Chemistry	5
+CH106 - Introductory Chemistry	5
+CH110 - Foundations of Chemistry	5
+CH221 - General Chemistry	5
+CH222 - General Chemistry	5
+CH223 - General Chemistry	5
+G101 - Introduction to Geology - Minerals and Rocks	4
+G102 - Introduction to Geology - Environmental Geology	4
+G103 - Introduction to Geology - Historical Geology	4
G145 - Geology of the Pacific Northwest	3
G146 - Rocks and Minerals	3
G147 - Basic Geology	3
+G201 - Physical Geology	4
+G202 - Physical Geology	4
+G203 - Historical Geology	4
GEOG101 - Physical Geography	4
+GS104 - Physical Science/Physics	4
+GS105 - Physical Science/Chemical Concepts	4
+GS107 - Physical Science/Astronomy	4
+GS110 - Physical Science/Energy	4
+GS111 - Physical Science/Forensic Science	4
+GS142 - Physical Geology/Earth Revealed	4
+PHY101 - Essentials of Physics	4
+PHY201 - General Physics	5

+PHY202 - General Physics	5
+PHY203 - General Physics	5
+PHY211 - General Physics with Calculus	5
+PHY212 - General Physics with Calculus	5
+PHY213 - General Physics with Calculus	5

Health/PE

Health/Physical Education	<i>Credits</i>
HE115 - Body Composition Assessment	1
HE250 - Personal Health	3
HE252 - First Aid	3
HE253 - Personal Nutrition	3
HPE295 - Health and Fitness for Life	3
PE131 - Introduction to Physical Education	3
PE185 - Physical Education Activity	1
PE290 - Lifeguard Training Review	1
PE291 - Lifeguard Training	2
PE292 - Water Safety Instructor/WSI	2
PE293 - Lifeguard Instructor Training/LGI	2

AAOT Electives

Agriculture	<i>Credits</i>
ANS121 - Animal Science	3
ANS221 - Horses and Horsemanship	3
ANS231 - Livestock Evaluation	3

Art	<i>Credits</i>
ART198 - Special Studies	1-3
ART298 - Special Studies	1-3

Business Technologies	<i>Credits</i>
BA101 - Introduction to Business	4
@BA131 - Introduction to Business Computing	4
BA198 - Special Studies	1-3
BA206 - Principles of Management	4
BA211 - Principles of Accounting	4
BA212 - Principles of Accounting	4
BA213 - Principles of Accounting	4
BA214 - Business Communications	3
BA215 - Cost Accounting	4
BA223 - Principles of Marketing	4
BA226 - Business Law	4
BA280 - Cooperative Work Experience	1-8
BA285 - Human Relations in Business	3
BA298 - Special Studies	1-3

College Prep	<i>Credits</i>
HD100 - College Survival and Success	3
HD109 - Academic Planning	1
HD110 - Career Planning	2
HD204 - Self-Motivation and Personal Potential	3
HD206 - Coping Skills for Stress	3
MS101 - Introduction to Leadership and Personal Development	2

Communications	<i>Credits</i>
COM100 - Human Communications	4
~COM237 - Gender and Communication	3

Criminal Justice	<i>Credits</i>
CJ100 - Introduction to Criminal Justice	3
CJ101 - Careers in Criminal Justice	3
CJ110 - Police Systems and Practices	3
CJ120 - American Court Systems and Practices	3
CJ130 - Correctional Systems and Practices	3
CJ132 - Probation and Parole: Systems and Practices	3
CJ198 - Special Studies	1-3
CJ200 - Theories of Crime and Delinquency	3
CJ201 - Juvenile Justice	3
CJ214 - Criminal Justice Report Writing	3
CJ220 - Criminal Law	3
CJ222 - Procedural Law	3
CJ227 - Ethics in Criminal Justice	3

English	<i>Credits</i>
ENG198 - Special Studies	1-3
ENG240 - Native American Literature	3
ENG280 - Cooperative Work Experience	1-8
PHL103 - Introduction to Philosophy	3
RD101 - College Textbook Reading	3
RD120 - Critical Reading and Thinking	3
RD220 - Advanced Critical Reading & Thinking	3
WR115 - Introduction to College Writing	4
WR123 - English Composition	3
WR198 - Special Studies	1-3
WR298 - Special Studies	1-3

Foreign Languages	<i>Credits</i>
SPAN101 - First Year Spanish	4
SPAN102 - First Year Spanish	4
SPAN103 - First Year Spanish	4
SPAN211 - Spanish Conversation and Composition	3
SPAN212 - Spanish Conversation and Composition	3
SPAN213 - Spanish Conversation and Composition	3
UMA101 - First Year Umatilla	4

Health/Physical Education	<i>Credits</i>
FN225 - Nutrition	4
PE198 - Special Studies	1-3
PE280 - Cooperative Work Experience	1-8

Math/Computer Science	<i>Credits</i>
CS125 - Software Applications	3
CS179 - Introduction to Networking	4
CS180 - Computer Science Practicum	4
CS198 - Special Studies	1-3
CS279 - Network Management II	4
CS280 - Cooperative Work Experience	1-8

Symbols:	@	- Computer Literacy
	~	- Cultural Awareness
	+	- Lab Science

Transfer Course List

CS288 - Network Management III	4	MUS298 - Special Studies	1-3	AGM250 - Irrigation Systems Design	3
CS298 - Special Studies	1-3			AGM251 - Irrigation Systems	3
MTH103 - Problem Solving with Technology	1	Science	<i>Credits</i>	AGR101 - Agriculture Orientation	1
MTH198 - Special Studies	1-3	BI160 - Local Ecosystems	1	@AGR111 - Agriculture Computers	3
MTH280 - Cooperative Work Experience	1-8	BI161 - Ecosystems Recovery	2	AGR200 - Pre-Employment Seminar	1
MTH298 - Special Studies	1-3	BI198 - Special Studies	1-3	AGR210 - Agriculture Accounting	4
		G198 - Special Studies	1-3	AGR211 - Agriculture Business Management	3
Music	<i>Credits</i>	GS160 - Observational Astronomy	3	AGR221 - Agriculture Marketing	3
MUP105 - Jazz Ensemble	1	GS198 - Special Studies	1-3	AGR226 - Agriculture Issues	3
MUP115 - General Ensemble	1	PHY198 - Special Studies	1-3	AGR280 - Cooperative Work Experience	1-8
MUP122 - Concert Choir	1			AGR296 - Production Problems	4
MUP125 - Vocal Jazz Ensemble	1	Social Science	<i>Credits</i>	ANS122 - Animal Science	3
MUP141 - Symphony Orchestra	1	ANTH298 - Special Studies	1-3	ANS198 - Special Studies	1-3
MUP168 - Applied Woodwinds	1	EC198 - Special Studies	1-3	ANS201 - Introduction to Equine Science	3
MUP169 - Applied Brass	1	GEOG298 - Special Studies	1-3	ANS211 - Animal Nutrition	4
MUP170 - Applied Strings	1	HST104 - World Civilizations I	3	ANS212 - Animal Nutrition Recitation	1
MUP171 - Applied Piano	1	HST105 - World Civilizations	3	ANS216 - Pregnancy Testing/Bovine	1
MUP173 - Applied Organ	1	HST298 - Special Studies	1-3	ANS217 - Artificial Insemination	3
MUP174 - Applied Voice	1	PS198 - Special Studies	1-3	ANS218 - Advanced Artificial Insemination	1
MUP191 - Applied Percussion	1	PSY119 - Process In Living	3	ANS220 - Beef Production	4
MUP205 - Jazz Ensemble	1	PSY198 - Special Studies	1-3	ANS222 - Sheep and Swine Production	4
MUP215 - General Ensemble	1	SOC198 - Special Studies	1-3	ANS232 - Livestock Evaluation	3
MUP222 - Concert Choir	1			ANS233 - Livestock Evaluation/Oral Reasons	1
MUP225 - Vocal Jazz Ensemble	1	Student Programs	<i>Credits</i>	ANS240 - Animal Health	5
MUP241 - Symphony Orchestra	1	HD151 - Service Leadership	1	CSS100 - Soils and Fertilizers	3
MUP268 - Applied Woodwinds	1	HD152 - Service Leadership	1	CSS201 - Principles of Crop Science	3
MUP269 - Applied Brass	1	HD153 - Service Leadership	1	CSS210 - Forage Crops	3
MUP270 - Applied Strings	1	HD154 - Ambassadorship	1	CSS240 - Pest Management	4
MUP271 - Applied Piano	1	HD254 - Ambassadorship	1	HORT100 - Plant Science	3
MUP273 - Applied Organ	1			HORT111 - Alternative Crop Production	3
MUP274 - Applied Voice	1	Teacher Ed/Ed Assistant	<i>Credits</i>	RNG241 - Range Management	3
MUP291 - Applied Percussion	1	ED100 - Introduction to Education	1		
MUS101 - Fundamentals of Music	2	ED113 - Instructional Strategies in Language Arts	3	Business Technologies	<i>Credits</i>
MUS105 - Music Appreciation	3	ED200 - Foundations of Education	3	BA104 - Business Mathematics	4
MUS107 - Studio Recording Techniques	2	ED229 - Learning and Development	3	BA105 - Business Mathematics	4
MUS108 - Studio Recording Techniques	2	ED254 - Instructional Strategies for English Language Learners	3	BA106 - Supervision of Table Games	4
MUS109 - Studio Recording Techniques	2	ED258 - Multicultural Education	3	BA107 - Survey of Gaming Regulations	4
MUS111 - Music Theory	4	ED280 - Cooperative Work Experience	1-8	BA108 - Slots Management I	4
MUS112 - Music Theory	4			BA109 - Academic Planning: Business Technologies	1
MUS113 - Music Theory	4	Theatre	<i>Credits</i>	BA110A - Business Computer Application/MS Access	3
MUS114 - Ear Training and Sight Singing	1	TA147 - Voice and Diction for the Theatre	3	BA110X - Business Computer Applications/MS Excel	3
MUS115 - Ear Training and Sight Singing	1	TA165 - Technical Theatre Workshop	3	BA111 - Basic Accounting	4
MUS116 - Ear Training and Sight Singing	1	TA180 - Theatre Rehearsal and Performance	3	BA113 - Credit Procedures	3
MUS131 - Class Piano	2			BA116 - Bookkeeping Practice	2
MUS132 - Class Piano	2	CTE Electives		BA155 - Introduction to Fraud Examination	3
MUS133 - Class Piano	2	PLEASE NOTE - All APR courses are CTE Electives. They are not listed here for the sake of brevity.		BA177 - Payroll Accounting	4
MUS135 - Class Voice	2			BA190 - Money Management	1
MUS198 - Special Studies	1-3	Agriculture	<i>Credits</i>	BA207 - E-Commerce	4
MUS201 - Introduction to Music and Its Literature	3	AGM131 - Agriculture Safety	3	BA209A - Accounting Applications	3
MUS202 - Introduction to Music and Its Literature	3	AGM140 - Agriculture Engines	3	BA209P - Accounting Applications/Payroll	4
MUS203 - Introduction to Music and Its Literature	3	AGM211 - Agriculture Construction and Surveying	3	BA209Q - Accounting Applications/QuickBooks	3
MUS211 - Music Theory	3	AGM221 - Metals and Welding	3		
MUS212 - Music Theory	3	AGM240 - Tractors	2		
MUS213 - Music Theory	3	AGM241 - Agriculture Machinery	3		
		AGM249 - Advanced Agricultural Shop	2		

Symbols:	@	- Computer Literacy
	~	- Cultural Awareness
	+	- Lab Science

Transfer Course List

BA210 - Microcomputer Applications - Advanced Excel	3	HTM109 - Introduction to the Lodging Industry	3	DSL176 - Mobile Air-Conditioning and Heating	3
BA220 - Tax Accounting	4	HTM112 - Bed and Breakfast Management	3	DSL181 - Shop Practices	3
BA221 - Accounting Problems/Tax	4	HTM127 - Selling in the Hospitality Industry	3	DSL184 - Fluid Mechanics	4
BA222 - Finance	3	HTM130 - Beverages	3	DSL191 - Electrical Systems I	4
BA224 - Human Resources Management	3	HTM131 - Customer Service Management I	3	DSL192 - Electrical Systems II	4
BA225 - Introduction to Gaming Management	4	HTM224 - Catering Operations	3	DSL193 - Electrical Systems III	4
BA238 - Personal Selling	3	HTM226 - Event Management	3	DSL196 - Electronic Diagnostics and Engine Emissions	3
BA239 - Retail Promotion	3	HTM230 - Hotel, Restaurant and Travel Law	3	DSL200 - Pre-Employment Seminar	1
BA249 - Retail Selling	3	HTM232 - Menu Design	3	DSL251 - Heavy Duty Brakes II	3
BA251 - Office Management	3			DSL262 - Engine Repair II	4
BA261 - Intermediate Accounting	4	Criminal Justice	<i>Credits</i>	DSL263 - Advanced Engine Technology	4
BA262 - Intermediate Accounting	4	CJ204 - Behavioral Cognitive Processes	4	DSL275 - Heavy Duty Equipment II	3
BA263 - Intermediate Accounting	4	CJ205 - Victimology	3	DSL280 - Cooperative Work Experience	1-8
BA265 - Accounting Problems	4	CJ210 - Police and Community	3	TTL101 - Introduction to Transportation and Logistics	4
BA268 - Introduction to Auditing	3	CJ212 - Criminal Investigation	3	TTL121 - Practical Applications in Transportation and Logistics	6
BA271 - Analyzing Financial Statements	3	CJ225 - Correctional Law	3	TTL141 - Transportation Customer Service Skills	3
BA277 - Business Ethics	3	CJ232 - Correctional Casework Counseling	3	TTL280 - Cooperative Work Experience	1-8
BA284 - Pre-Employment Seminar	1	CJ240 - Crime, Justice and Diversity	3	WLD111 - Basic Gas and Arc Welding	3
BA295 - Professional Bookkeeping Review	3	CJ243 - Narcotics and Dangerous Drugs	3	WLD112 - Advanced Arc Welding	3
BT116 - Office Procedures	3	CJ250 - Criminal Justice Administration	3	WLD221 - TIG Welding	3
BT120 - Computer Keyboarding	2	CJ280 - Cooperative Work Experience	1-8	WLD253 - Welding Practices for Certification	3
BT121 - Document Processing I	3			WLD256 - Pipe Welding for Certification	3
BT122 - Document Processing II	3	Dental Assisting	<i>Credits</i>		
BT123 - Document Processing III	3	DA141 - Dental Radiology	4	Early Childhood Ed.	<i>Credits</i>
BT124 - Keyboarding for Speed & Accuracy	3	DA142 - Dental Radiology	3	ECE100 - Developmentally Appropriate Practice in Early Childhood Ed	3
BT131 - Legal Office Procedures	3	DA143 - Dental Radiology	1	ECE101 - Family and Community Relations	3
BT140 - Business Document Editing	3	DA151 - Chairside Procedures I	4	ECE111 - Introduction to ECE Environments	3
BT201M - Word Processing/MS Word	3	DA152 - Chairside Procedures	3	ECE112 - Introduction to Early Childhood Education/ Professionalism	1
BT202M - Word Processing/MS Word	3	DA153 - Chairside Procedures	2	ECE113 - Introduction to Early Childhood Education/Child Advocacy	1
BT204 - Advanced Word Processing Applications	3	DA154 - Dental Specialties	2	ECE150 - Observation/Assessment and Recording	3
BT206 - Desktop Publishing	3	DA162 - Clinical Practice	4	ECE151 - Guidance and Classroom Management	3
BT220 - Calculating Machines	3	DA163 - Clinical Practice	8	ECE152 - Creativity for Young Children	3
BT225 - Machine Transcription	2	DA166 - Clinical Practice Seminar	1	ECE153 - Music and Movement	3
BT226 - Advanced Machine Transcription	2	DA170 - Basic Dental Science	3	ECE154 - Literature and Literacy	3
BT230 - Legal Terminology I	3	DA172 - Dental Anatomy	4	ECE175A - Infant/Toddler Caregiving: Social Emotional Growth	1
BT231 - Legal Transcription	3	DA174 - Dental Pathology	1	ECE175B - Infant/Toddler Caregiving: Group Care	1
BT232 - Legal Terminology II	3	DA176 - Dental Pharmacology	1	ECE175C - Infant/Toddler Caregiving: Learning and Development	1
BT240 - Records Management	3	DA180 - Dental Materials	3	ECE175D - Infant/Toddler Caregiving: Culture, Family and Provider	1
BT251 - Medical Terminology	3	DA182 - Dental Materials and Procedures	2	ECE198 - Special Studies	1-3
BT252 - Medical Terminology	3	DA190 - Dental Health Education	2	ECE226 - Child Development	3
BT253 - Medical Transcription	3	DA192 - Dental Law and Ethics	1	ECE227 - Enhancing Social Emotional Development	3
BT254 - Medical Transcription	3	DA194 - Dental Business Office	2	ECE240 - Curriculum/Planning	3
BT255 - Medical Transcription	3	DA196 - Medical Emergencies in the Dental Office	1	ECE245 - Challenging Behavior in Young Children	3
BT257 - Medical Office Procedures	3			ECE248 - Overview of Special Services	3
BT258 - Medical Insurance Procedures and Coding	3	Diesel/Welding/PTD	<i>Credits</i>		
BT290 - Integrated Office Systems	3	DSL141 - Heavy Duty Steering and Suspension	4		
HTM100 - Hospitality and Tourism Industry	3	DSL151 - Heavy Duty Brakes I	3		
HTM103 - Marketing in the Hospitality Industry	3	DSL152 - Manual Drive Trains I	3		
HTM104 - Travel and Tourism Industry	3	DSL153 - Manual Drive Trains II	3		
HTM105 - Food and Beverage Industry	3	DSL161 - Diesel Engines	4		
HTM107 - Hospitality Cost Control	3	DSL162 - Engine Repair I	4		
		DSL175 - Heavy Duty Equipment	3		

Symbols:	@	- Computer Literacy
	~	- Cultural Awareness
	+	- Lab Science

Transfer Course List

ECE249 - Inclusion of Children with Special Needs	3	GT112 - Control systems	3	ED262 - Behavior Management for Autism Spectrum Disorders	3
ECE280 - Cooperative Work Experience	1-8	GT113 - Fluid Power	3	ED263 - Communication Strategies for Autism Spectrum Disorder	3
ECE295 - Child Care Administration	3	GT114 - Local Applications/Alternative Energy	3	ED266 - Current Issues in Special Education	3
ECE296 - Issues and Trends	3	GT115 - Human Relations/Customer Service	3	ED268 - Educating Mildly and Severely Handicapped	3
Emergency Medical Technician	<i>Credits</i>	SUR161 - Plane Surveying	5	ED285 - Signing Exact English	3
EMT115 - Crisis Intervention	3	SUR162 - Surveying and Mapping	5	ED286 - Signing Exact English	3
EMT151 - EMT Basic Part A	5	SUR166 - Highway Fundamentals	3	ED287 - Signing Exact English	3
EMT152 - EMT Basic Part B	5	SUR167 - Surveying Seminar	3	ED298 - Special Studies	1-3
EMT169 - EMT Rescue	3	Health/Physical Education	<i>Credits</i>		
EMT175 - Intro. To Emergency Medical Services	4	FN230 - Children, Families and Nutrition	3		
EMT176 - Emergency Response Patient Transportation	2	HE100 - Introduction to Health Services	3		
EMT177 - Emergency Response Communication//Documentation	2	HE298 - Special Studies	1-3		
Engineering Tech/Civil-Drafting	<i>Credits</i>	Math/Computer Science	<i>Credits</i>		
CET111 - Introduction to Engineering Technology	3	MTH084 - Technical Mathematics for Civil Engineer Technicians	2		
CET112 - Computer Aided Drafting	3	Nursing	<i>Credits</i>		
CET113 - Advanced Computer Aided Drafting	3	NRS110 - Foundations of Nursing - Health Promotion	9		
CET114 - Introduction to Geographic Information Systems	3	NRS111 - Foundations of Nursing in Chronic Illness I	6		
CET145 - Engineering Graphics	3	NRS112 - Foundations of Nursing in Acute Care I	6		
CET162 - Engineering Materials	3	NRS221 - Foundations of Nursing in Chronic Illness II/End of Life	9		
CET205 - Structural Drafting	3	NRS222 - Foundations of Nursing in Acute Care II/End of Life	9		
CET215 - Contract Documents	4	NRS224 - Scope of Practice/Integrated Practicum	9		
CET222 - Concrete Practices	4	NRS230 - Clinical Pharmacology I	3		
CET222A - Concrete Field Testing Technician	1	NRS231 - Clinical Pharmacology II	3		
CET222B - Concrete Control Technician	1	NRS232 - Pathophysiological Processes I	3		
CET222C - Concrete Strength Testing Technician	1	NRS233 - Pathophysiological Processes II	3		
CET223 - Soil Mechanics	3	PHC211 - Pharmacology	2		
CET231 - Structures	4	PHC212 - Pharmacology	2		
CET235 - Structures	4	Teacher Ed/Ed Assistant	<i>Credits</i>		
CET251 - Estimating Construction Costs	4	ED114 - Instructional Strategies in Math and Science	3		
CET261 - Hydraulics	4	ED125 - Peer Tutoring/ED 125	1		
CET263 - 3-D Computer Aided Drafting	3	ED130 - Comprehensive Classroom Management	3		
CET265 - Hydraulics II	4	ED131 - Instructional Strategies	3		
CET280 - Cooperative Work Experience	1-8	ED157 - Introduction to Mathematical Explorations	3		
GT101 - Introduction to Industrial Sustainability	3	ED169 - Overview of Students with Special Needs	3		
GT102 - Green Industrial Safety	2	@ED235 - Educational Technology	3		
GT103 - Mechanical Systems	3	ED250 - Second Language Acquisition	2		
GT104 - Electrical Systems Troubleshooting I	3	ED251 - Literacy Development for Second Language Learners	3		
GT105 - Workplace Math/Applied Math	4	ED252 - Technology and Second Language Learners	2		
GT106 - Introduction to Green Technologies	2	ED255 - Bilingual Education/ELD Strategies	3		
GT107 - Electrical Systems Troubleshooting II	3	ED260 - Overview of Autism Spectrum Disorders	3		
GT108 - Building Systems	2	ED261 - Instructional Strategies for Autism Spectrum Disorders	3		
GT109 - HVACR Systems Operations	3				
GT110 - Workplace Communications	3				
GT111 - Preventive Maintenance/Energy Conservation	2				

Symbols:	@	- Computer Literacy
	~	- Cultural Awareness
	+	- Lab Science

Math/Writing Progression

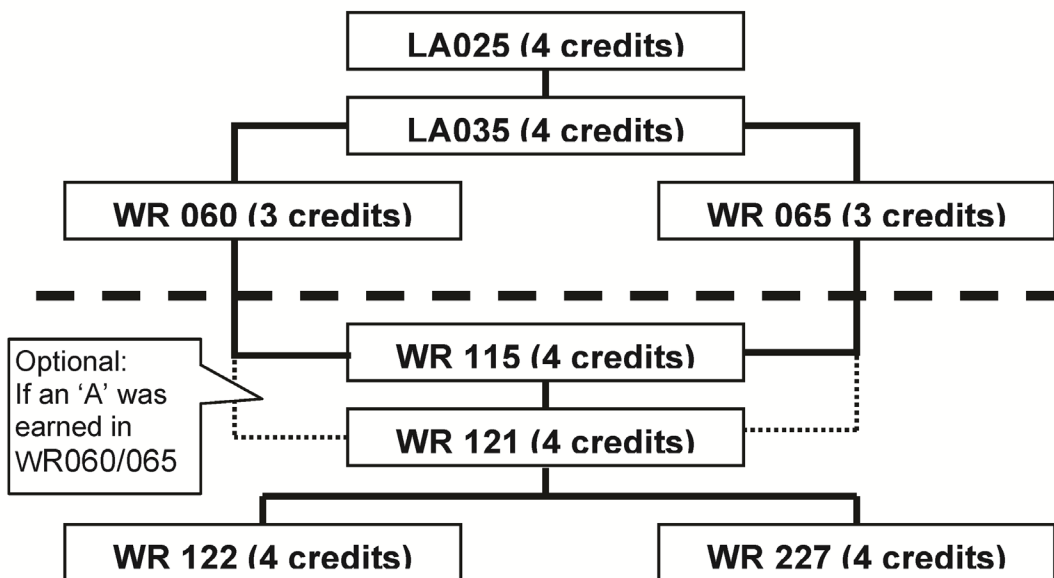
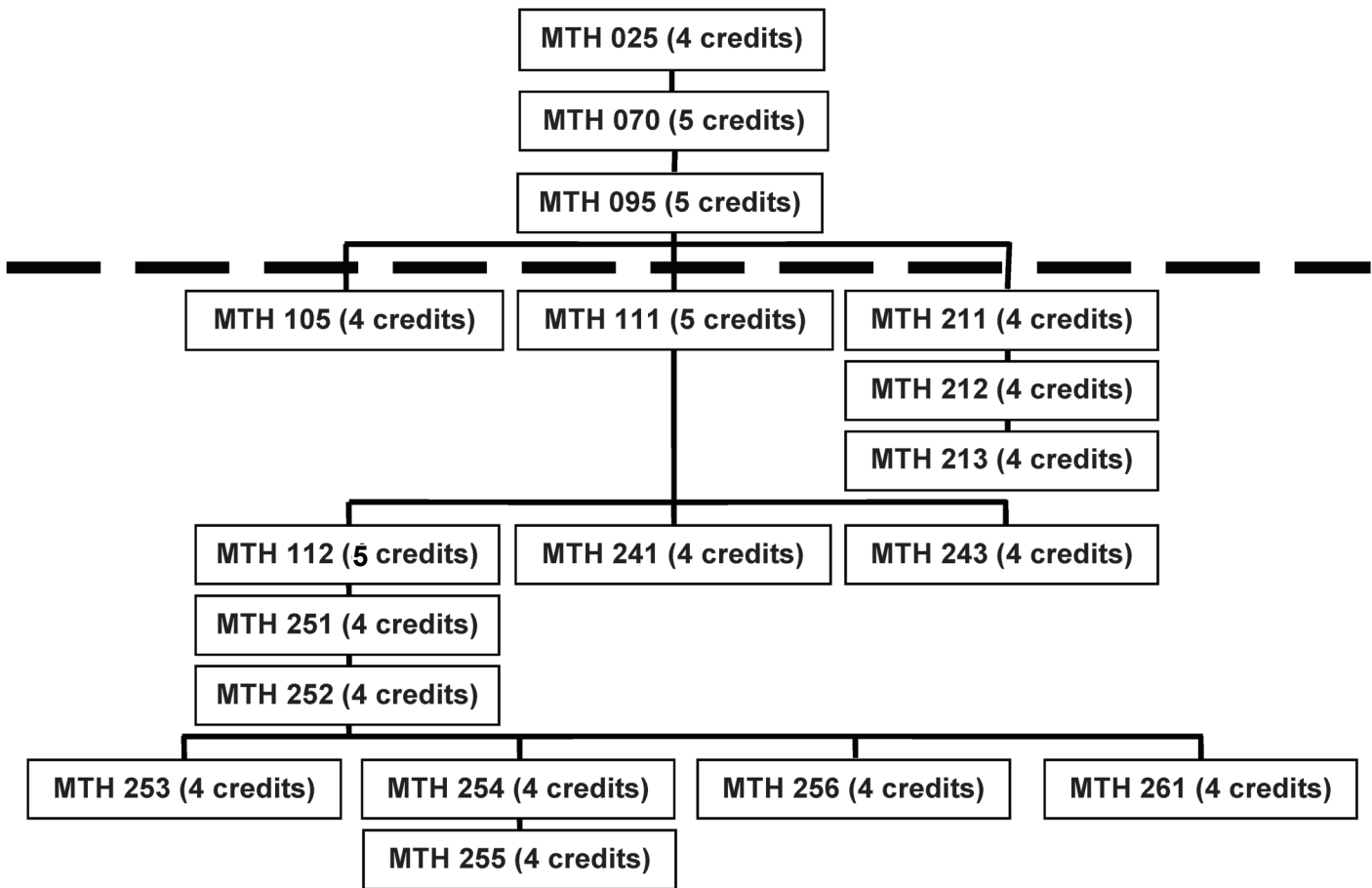

Course Descriptions

Courses offered at BMCC are listed in this section of the catalog. Not every course is offered every term. Use the schedule of classes to determine quarterly course offerings. Students who plan to transfer should consult with their program advisor to ensure course transferability.

HOW TO READ A COURSE DESCRIPTION

Courses are grouped by area of study and listed alphabetically by letter prefix and course number. Courses numbered 100 and above are designed for transfer to other colleges for degree credit.

AGRICULTURE SAFETY..... The title of the course is listed in all capital letters.

A basic course in agricultural safety..... The course description briefly summarizes the course content.

Credits - 3 Lecture - 2 Lab - 1 The number of credits earned by taking the course is noted. Each lecture credit corresponds to one hour of instruction per week. Each lab credit equals 3 hours per week. Each other credit generally refers to 2 hours of class time per credit.

Prerequisite or Prerequisites are listed below course descriptions. A prerequisite is a course that must be completed before enrolling in the selected course. It is important to note prerequisites before registering.

Corequisite Corequisite is a course that should be completed either before or while attending the selected course.

Explanation of Course Designations:

Symbols designate how courses fulfill various degrees as defined below.

(^) – A transferable course that can be used to fulfill undesignated elective requirements in the associate’s degree programs.

(*) – A transferable course that meets distribution (group) requirements in the associate of arts Oregon transfer (A.A.O.T.) degree and the associate of science (A.S.) degree. Note: Courses meeting distribution requirements may always be used as electives in the transfer degrees.

(+) – Courses that meet the laboratory requirement.

(>) – A maximum of 12 credits of college-level career and technical courses may be used as electives in the A.A.O.T. and the A.A.S. degrees.

Questions regarding suitability of courses should be directed to the program advisor, associate vice president of enrollment management, or vice president of instruction.

Non-Designated Courses

Courses numbered 100 and above listed in this section of the catalog that have not received a designation mark as outlined above may or may not meet degree requirements or be transferable to other institutions. Questions regarding transferability of courses should be directed to the program advisor, associate vice president of enrollment management, or vice president of instruction.

Non-Transfer Courses

Courses with numerical designations less than 100 are not transferable to four-year institutions.

AGM Agriculture

>AGM131 - Agriculture Safety

Credits - 3 Lecture - 2 Lab - 1

A basic course in agricultural safety covering hand and power tools, equipment, chemical and environmental safety. Students will develop safe working habits and identify and correct safety hazards.

Term(s) Offered: Fall

>AGM140 - Agriculture Engines

Credits - 3 Lecture - 2 Lab - 1

Students develop a practical understanding of the functioning, operation, and maintenance of the internal combustion engine particularly as it is used in agricultural operations.

Term(s) Offered: Winter

>AGM211 - Agriculture Construction and Surveying

Credits - 3 Lecture - 2 Lab - 1

Surveying, leveling and construction in agricultural applications.

Term(s) Offered: Fall

>AGM221 - Metals and Welding

Credits - 3 Lecture - 2 Lab - 1

A basic course in welding using oxyacetylene torches and electric arc welding equipment emphasizing the development of skills and knowledge to safely and effectively accomplish practical repairs and fabrication in agricultural applications.

Term(s) Offered: Winter

>AGM240 - Tractors

Credits - 2 Lecture - 1 Lab - 1

This course will acquaint students with agricultural tractors and their systems. Labs will be used extensively to develop student skills in operation and maintenance of tractors. Maneuvering, attaching, detaching, and using implements will be stressed.

Term(s) Offered: Fall

>AGM241 - Agriculture Machinery

Credits - 3 Lecture - 2 Lab - 1

Tillage, planting, and harvest equipment used in Eastern Oregon agriculture covering economic factors, operation principles, adjustments, and maintenance of commonly used machines.

Term(s) Offered: Spring

>AGM249 - Advanced Agricultural Shop

Credits - 2 Other - 2

Designed to build student skills in metalworking, woodworking, and agricultural mechanics with a laboratory element to allow time for in-depth practice as well as provide time for individual projects.

Term(s) Offered: Winter

Symbols:

* - Discipline Studies	^ - Elective
@ - Computer Literacy	+ - Lab Science
~ - Cultural Awareness	> - C/T Elective

AGM Agriculture

>AGM250 - Irrigation Systems Design

Credits - 3 Lecture - 2 Lab - 1

Designing drip, low pressure, and sprinkler irrigation systems with an emphasis on horticultural and field crop applications from pump to output nozzle.

Term(s) Offered: Winter

>AGM251 - Irrigation Systems

Credits - 3 Lecture - 2 Lab - 1

Application of design skills learned in Irrigation Systems Design to actual in-field situations. Field trips will explore different applications of irrigation. Contemporary water issues will be discussed.

Recommended preparation: AGM250

Term(s) Offered: Spring

AGR Agriculture

>AGR101 - Agriculture Orientation

Credits - 1 Lecture - 1

Students will explore successful learning opportunities available at Blue Mountain Community College and develop plans to successfully complete their program of study. Special review will be given to agricultural program areas. Agriculture department instructors and staff will introduce students to financial aid, the library, and the student service center.

Term(s) Offered: Fall

@>AGR111 - Agriculture Computers

Credits - 3 Lecture - 2 Lab - 1

Application of personal microcomputers to farm and ranch situations. Use and evaluation of spread sheets, data bases, and word processing software are covered.

Term(s) Offered: Fall

>AGR200 - Pre-Employment Seminar

Credits - 1 Lecture - 1

A class designed to assist the student in securing employment. Job-hunting techniques, interviewing skills, and the study of job related responsibilities and problems while advancing in a chosen career are major topics covered. A seminar format is used to encourage student participation.

Term(s) Offered: Winter

>AGR210 - Agriculture Accounting

Credits - 4 Lecture - 4

Simulation of ranch and farm record keeping including maintaining payroll, depreciation, cash flow and inventory records. Computer spreadsheets are used to assist in analysis of various farm/ranch enterprises.

Term(s) Offered: Fall

AGR Agriculture

>AGR211 - Agriculture Business Management

Credits - 3 Lecture - 2 Lab - 1

The study of the four basic assets needed to begin any farm or ranch business. Land, labor, capital, and management are evaluated to ascertain each component's ability to produce maximum economic returns.

Term(s) Offered: Winter

>AGR221 - Agriculture Marketing

Credits - 3 Lecture - 3

The complex agriculture marketing process including study of the marketing system, marketing a specific farm commodity, and the importance of organization in marketing agricultural products.

Term(s) Offered: Spring

>AGR226 - Agriculture Issues

Credits - 3 Lecture - 2 Lab - 1

Students will study current topics causing change in the agricultural industry. Students may research and report on trends as diverse as animal rights, chemicals and foods, land use, water rights, government subsidies, and others.

Term(s) Offered: Fall

>AGR280 - Cooperative Work Experience

Credits - 1-8

Offered to agriculture students to work on-the-job in various agricultural fields to gain elective credits from BMCC. Also required in conjunction with several courses in our program.

Term(s) Offered: Fall, Winter, Spring

>AGR296 - Production Problems

Credits - 4 Lecture - 4

Students will select an area related to agriculture and do a feasibility study or an economic analysis. Currently published figures will be used. The report will contain all information needed to make a justifiable and cost beneficial decision.

Term(s) Offered: Spring

ANS Agriculture

ANS031 - Basics of Horse Trimming and Shoeing

Credits - 1 Lab - 1

A course emphasizing horse hoof trimming, hoof care and basic shoeing. The course will be taught with hands-on experience for private horse owners and horse enthusiasts.

Course Descriptions

ANS

Agriculture

^ANS121 - Animal Science

Credits - 3 Lecture - 2 Lab - 1

Designed to familiarize students with the various phases of animal science and the modern livestock industry. Major subject areas discussed are: the livestock industry, livestock breeds, animal products, grading, and nutrition fundamentals. Labs involve students in hands-on experience and field trips.

Term(s) Offered: Winter

>ANS122 - Animal Science

Credits - 3 Lecture - 2 Lab - 1

Approved practices in the modern livestock industry. Students gain technical knowledge in livestock reproduction, genetics, and modern breeds. Emphasis is placed upon performing skills commonly used by successful ranchers.

ANS121 preferred not required.

Term(s) Offered: Winter, Spring

>ANS198 - Special Studies

Credits - 1-3

Designed to provide interested and capable students with the opportunity to study special topics in the animal sciences.

>ANS201 - Introduction to Equine Science

Credits - 3 Lecture - 2 Lab - 1

This course is an introductory course in equine science. The course emphasizes the effects of natural selection on natural and domesticated horses, selection of horses by breed and evaluation of conformation, tack selection and care, nutrition and feed rations, basic handling of horses from the ground, and general health care. Labs will parallel topics in lecture and provide students with practical applications of techniques discussed.

Term(s) Offered: Fall

>ANS211 - Animal Nutrition

Credits - 4 Lecture - 3 Lab - 1

Designed to develop an understanding of applied animal nutrition. This course will cover proteins, carbohydrates, lipids, vitamins, minerals, and the use of these nutrients by livestock. Rations will be balanced during the laboratory sessions.

Corequisite: AGR280

Recommended preparation: ANS121

Term(s) Offered: Winter

ANS

Agriculture

>ANS212 - Animal Nutrition Recitation

Credits - 1 Lecture - 1

This class functions as a help session and a supplement for ANS 211 to enable students to become more proficient in balancing livestock rations. While many students can balance rations quickly and efficiently from the knowledge and skills gained in lecture and labs, others need additional instruction.

Corequisite: ANS211

Term(s) Offered: Winter

>ANS216 - Pregnancy Testing/Bovine

Credits - 1 Lab - 1

This course is a "hands-in" course requiring students to pregnancy check a minimum of fifty cows to become proficient. This class has an open lab to accommodate students and give all adequate time to develop a high level of proficiency.

Recommended preparation: ANS121, ANS122 and instructor approval.

Term(s) Offered: Fall

>ANS217 - Artificial Insemination

Credits - 3 Lecture - 2 Lab - 1

Basic considerations of reproductive physiology and artificial insemination of livestock. Emphasis in the lab is placed on the application of lecture material and developing proficiency in the artificial insemination of cattle.

Recommended preparation: ANS121 and ANS122

Term(s) Offered: Spring

>ANS218 - Advanced Artificial Insemination

Credits - 1 Lab - 1

A course where students act as teaching assistants in the class to assure that this "hands-in" activity proceeds properly and safely. A.I. is a technical, difficult task requiring a great deal of practice and supervision to be done properly.

Prerequisite: ANS217

>ANS220 - Beef Production

Credits - 4 Lecture - 3 Lab - 1

Designed to enable students to learn proven practices in modern beef production. Students will develop skills which can lead to a successful cattle operation.

Offered in even numbered years. Completion of ANS121 and ANS122 recommended but not required.

Term(s) Offered: Winter

ANS

Agriculture

^ANS221 - Horses and Horsemanship

Credits - 3 Lecture - 3 Lab - 1

Horse training, behavior, reproduction, nutrition, and diseases. The laboratory portion of the class will involve students in basic horsemanship techniques for breaking, training, evaluating, and caring properly for horses.

Term(s) Offered: Spring

>ANS222 - Sheep and Swine Production

Credits - 4 Lecture - 3 Lab - 1

Fundamentals of modern sheep and swine production. Students develop skills and learn up-to-date, practical information. Offered in odd numbered years.

Completion of ANS121 and ANS122 recommended but not required.

Term(s) Offered: Winter

^ANS231 - Livestock Evaluation

Credits - 3 Lecture - 2 Lab - 1

The subject of livestock judging and evaluation is presented in a practical and direct manner. Classroom study of current type and market demand is combined with actual livestock judging experience. Classes of cattle, sheep, swine, and horses will be judged.

Term(s) Offered: Spring

>ANS232 - Livestock Evaluation

Credits - 3 Lecture - 2 Lab - 1

More fully develops the principles emphasized in the first quarter. More time is spent in actual judging. Oral reasons for many of the classes are required. Students from this class participate on our intercollegiate livestock judging team.

Recommended preparation: AGM231 or instructor approval.

Term(s) Offered: Fall

>ANS233 - Livestock Evaluation/Oral Reasons

Credits - 1 Lab - 1

Oral reasons are given by Livestock Evaluation students to enhance their public speaking ability and to clearly define and justify their placements. This skill is critical to members of the Livestock Judging Team at BMCC. This training is recommended for other students who wish to improve their communication skills.

Completion of or concurrent enrollment in ANS231 required.

Term(s) Offered: Fall

>ANS240 - Animal Health

Credits - 5 Lecture - 4 Other - 1

Disease control as it relates to today's modern livestock operation, including detailed study of health problems in beef cattle and study of horse, sheep and swine diseases. The lab develops student competency in practical and useful animal health skills.

Term(s) Offered: Spring

Symbols:

* - Discipline Studies ^ - Elective
@ - Computer Literacy + - Lab Science
~ - Cultural Awareness > - C/T Elective

ANTH

Social Science

*ANTH101 - Introduction to Physical Anthropology

Credits - 4 Lecture - 4

Principles of evolution applied to evidence for human physical change and development; study of fossil humans and human variation. Satisfies science group requirements at some four-year colleges.

Prerequisite: WR115 or Placement

NOTE: Prerequisite is for spring term only; WR060 or placement winter term.

Term(s) Offered: Fall

*ANTH102 - Introduction to Archaeology and Prehistory

Credits - 4 Lecture - 4

Study of archaeological methods and evidence for the evolution of human cultures and an understanding of how and why cultures change.

Prerequisite: WR115 or Placement

Recommended preparation: CS080. NOTE: Prerequisite is for spring term only; WR060 or placement winter term.

Term(s) Offered: Winter

~*ANTH103 - Introduction to Cultural Anthropology

Credits - 4 Lecture - 4

Study of the organization and functioning of selected world cultures, both Western and non-Western groups.

Prerequisite: WR115 or Placement

NOTE: Prerequisite is for spring term only; WR060 or placement winter term.

Term(s) Offered: Fall, Winter, Spring

^ANTH298 - Special Studies

Credits - 1-3

Special topics in anthropology.

Recommended preparation: WR060

APR

Apprenticeship

>APR110A - Plumbing Apprenticeship Fundamentals

Credits - 4 Lecture - 4

This course will familiarize the apprentice with a brief history of plumbing laws governing the plumbing trade; materials and methods for installation and maintenance of potable water systems, waste and sewage disposal; the definitions, fundamentals rules, purpose and scope of the Uniform Plumbing Code (UPC).

APR

Apprenticeship

>APR110B - Plumbing Apprenticeship Math and Basic Installation

Credits - 4 Lecture - 4

This course covers the practical application of basic math to plumbing calculations and familiarize the apprentice with basic installation practices utilizing the fundamental rules of the Uniform Plumbing Code and on-the-job Occupational Health and Safety requirements.

>APR110C - Plumbing Apprenticeship Print Reading

Credits - 4 Lecture - 4

This course covers installation practices for potable water, piping materials and methods for installation and maintenance of potable water systems, waste and sewage disposal, the definitions, fundamental rules, purpose and scope of the Uniform Plumbing Code (UPC).

>APR110D - Plumbing Apprenticeship Basic Installation

Credits - 4 Lecture - 4

In this course, the apprentice will become familiar with the proper techniques for installing sanitary drainage systems, gas and electric tank type water heaters and tankless water heaters, Uniform Plumbing Code and Occupational Safety and Health Association (OSHA) requirements.

>APR110E - Plumbing Apprenticeship Occupancy

Credits - 4 Lecture - 4

In this course, the plumbing apprentice will become familiar with advanced levels of blueprint reading and specialty drawings; installation of sewage and drainage systems and further study of installation and safety practices.

>APR110F - Plumbing Apprenticeship Advanced Waste System

Credits - 4 Lecture - 4

This course will introduce the apprentice to several aspects of the plumbing trade, including the range of materials approved for venting purposes, the raising or lifting of waste materials to the elevation of the building drain by means of sump pumps, sewage pumps and sewage ejectors; the use of traps to prevent dangerous gases from escaping into building; and further study of installation and safety practices. Chapters 9 & 10 of the UPC.

>APR111A - LMPE Apprenticeship Fundamentals

Credits - 4 Lecture - 4

Related training for the LMPE Electrical Apprentice. Subject area will enable the apprentice to receive the technical knowledge of the skills required of an LMPE Electrician. Context will include trade history and concepts, trade math, basic electrical DC theory, and introduction to National Electrical Code.

APR

Apprenticeship

>APR111B - LMPE Apprenticeship AC/DC Circuits

Credits - 4 Lecture - 4

Related training for LMPE Electrical Apprentice. The student will receive the technical knowledge of the skills required of an LMPE Electrician. Content will cover mathematical formulas of equations, basic AC theory, use of test equipment and applicable National Electrical Code.

>APR111C - LMPE Apprenticeship Measurement

Credits - 4 Lecture - 4

This course is designed to familiarize the LMPE Electrical apprentice with advanced aspects of electrical theory, math and power distribution along with practical residential wiring and the National Electrical Code.

>APR111D - LMPE Apprenticeship Theory

Credits - 4 Lecture - 4

This course covers related training for the LMPE Electrical Apprentice. The student will receive the technical knowledge of the skills required of an LMPE Electrician. Course content includes the requirements for wiring and installation of electrical devices, transformers, over-current devices, wire devices, hazardous locations, residential calculation and application of the National Electrical Code.

>APR111E - LMPE Apprenticeship Wiring and Print Reading

Credits - 4 Lecture - 4

This course covers related training for LMPE Apprentice. The apprentice will receive the technical knowledge of the skills required of an LMPE Electrician. The content will include requirements for wiring and installation of electrical devices, auxiliary gutters, raceways, fuses and over-current devices, wire devices, hazardous locations, busways, residential calculation and applicable national electrical code.

>APR111F - LMPE Apprenticeship Installation

Credits - 4 Lecture - 4

This course covers the requirements for wiring and installation of electrical devices, auxiliary gutters, raceways, fuses and over-current devices, hazardous locations, busways, residential calculation and applicable National Electrical Code for LMPE electrician apprentices.

Symbols:

* - Discipline Studies ^ - Elective
 @ - Computer Literacy + - Lab Science
 ~ - Cultural Awareness > - C/T Elective

Course Descriptions

APR Apprenticeship

>APR112A - Inside Electrical Apprenticeship Fundamentals

Credits - 4 Lecture - 4

Related training for Inside Wire Electrician Apprentice. Subject area will enable the apprentice to receive the technical knowledge of the skills required of an Inside Wire Electrician. Context will include trade history and concepts, trade math, basic electrical DC theory, and introduction to National Electrical Code.

>APR112B - Inside Electrician Apprenticeship AC/DC Circuits

Credits - 4 Lecture - 4

Related training for Inside Wire Electrician Apprentice. The student will receive the technical knowledge of the skills required of an Inside Wire Electrician. Content will cover mathematical formulas of equations, basic AC theory, use of test equipment and applicable National Electrical Code.

>APR112C - Inside Electrical Apprenticeship Measurement

Credits - 4 Lecture - 4

This course is designed to familiarize the Inside Electrical apprentice with advanced aspects of electrical theory, math and power distribution along with practical residential wiring and the National Electrical Code.

>APR112D - Inside Electrical Apprenticeship Theory

Credits - 4 Lecture - 4

This course covers related training for the Inside Wire Electrician Apprentice. The student will receive the technical knowledge of the skills required of an Inside Wire Electrician. Course content includes the requirements for wiring and installation of electrical devices, transformers, over-current devices, wire devices, hazardous locations, residential calculation and application of the National Electrical Code.

>APR112E - Inside Electrical Apprenticeship Wiring and Print Reading

Credits - 4 Lecture - 4

This course covers related training for Inside Wire Electrician Apprentice. The apprentice will receive the technical knowledge of the skills required of an Inside Wire Electrician. The content will include requirements for wiring and installation of electrical devices, auxiliary gutters, raceways, fuses and over-current devices, wire devices, hazardous locations, busways, residential calculation and applicable national electrical code.

APR Apprenticeship

>APR112F - Inside Electrician Apprenticeship Installation

Credits - 4 Lecture - 4

This course covers the requirements for wiring and installation of electrical devices, auxiliary gutters, raceways, fuses and over-current devices, hazardous locations, busways, residential calculation and applicable National Electrical Code for Inside Wire Electrician apprentices.

>APR114A - PLC Apprenticeship Hardware/Number Systems

Credits - 4 Lecture - 4

This course covers related training for the Programmable Logic Controller (PLC) apprentice to study theory and trade practices. Content includes an introduction to the trade, application, scope requirements, design, development, documentation, troubleshooting, programming, analog interface, and Input/Output concepts needed for understanding PLC's in the workplace.

>APR114B - PLC Apprenticeship Programming Fundamentals

Credits - 4 Lecture - 4

This course covers related training for Programmable Logic Controller (PLC) apprentices to study theory and trade practices with content focused on input and output modules, creating a modular PLC, processors, introduction to ControlNet/DeviceNet, data organization, and basic relay instructions.

>APR114C - PLC Apprenticeship Timers, Counters, Controls

Credits - 4 Lecture - 4

This course covers related training for Programmable Logic Controller (PLC) apprentices to study theory and trade practices, the course includes relay instructions, programmable controller input modules, system documenting, timer and counter instructions, comparison, data-handling, sequencer, and program flow instructions.

>APR115A - LME Apprenticeship Fundamentals

Credits - 4 Lecture - 4

Related training for the LME Electrical Apprentice. Subject area will enable the apprentice to receive the technical knowledge of the skills required of an LME Electrician. Context will include trade history and concepts, trade math, basic electrical DC theory, and introduction to National Electrical Code.

APR Apprenticeship

>APR115B - LME Apprenticeship AC/DC Circuits

Credits - 4 Lecture - 4

Related training for LME Electrical Apprentice. The student will receive the technical knowledge of the skills required of an LME Electrician. Content will cover mathematical formulas of equations, basic AC theory, use of test equipment and applicable National Electrical Code.

>APR115C - LME Apprenticeship Blueprint Reading

Credits - 4 Lecture - 4

This course covers related training for LME Apprentice. The apprentice will receive the technical knowledge of the skills required of an LME Electrician. The content will include requirements for wiring and installation of electrical devices, auxiliary gutters, raceways, fuses and over-current devices, wire devices, hazardous locations, busways, residential calculation and applicable national electrical code.

>APR117A - IMM Apprenticeship Reading Blueprints and Schematics

Credits - 3 Lecture - 3

This course covers all varieties of blueprints, schematics, and symbols used in commercial and industrial settings. Examines symbols on schematics, electrical symbols, diagrams, hydraulic, pneumatic, and piping. Discusses machine parts and machine drawings. Introduces sketching used in industrial plants including welding and joining symbols.

>APR117B - IMM Apprenticeship - Industrial Math/Measurement

Credits - 3 Lecture - 3

This course covers measurement and mathematical basics used in commercial and industrial applications. Examines all aspects of basic measurement concepts and procedures. Explains how to use scales and rules, combination calipers, and micrometers. Examines common fractions and decimals, powers and roots. Moves on to cover geometry, algebra, and formulas for problem solving. Concludes by explaining properties of triangles.

>APR117C - IMM Apprenticeship Metals in the Plant

Credits - 1 Lecture - 1

This course introduces metals, metallurgy, and metalworking used in industry. Discusses the properties of metals, including their mechanical properties. Examines industrial manufacturing processes. Covers iron and standard steels. Explains the different kinds of heat treatment and their usage. Discusses some techniques of working with copper, aluminum, magnesium, titanium, lead, nickel, tin, and zinc.

Symbols:

* - Discipline Studies ^ - Elective
@ - Computer Literacy + - Lab Science
~ - Cultural Awareness > - C/T Elective

APR Apprenticeship

>APR117D - IMM Apprenticeship Nonmetals in the Plant

Credits - 1 Lecture - 1

This course introduces major nonmetal materials and how they are most frequently used. Describes, properties, characteristics, and classifications of each material. Covers synthetic and natural materials. Examines various paints and coatings, their proper use, preparation, and application. Surveys industrial chemicals. Chemical safety precautions are covered, along with the proper use of protective equipment.

>APR117E - IMM Apprenticeship Hand Tools

Credits - 1 Lecture - 1

This course covers the most important hand tools used in the industrial workplace. The course includes the proper use of measuring tools, including a discussion of units of measurement. Examines the various kinds of wrenches and screwdrivers, their uses and handling techniques. Explains various hand tools by specialty: pipefitting tools, plumbing tools, electrician's tools, sheet metalworking tools, machinists' metal-working tools, hoisting and pulling tools.

>APR117F - IMM Apprenticeship Portable Power Tools

Credits - 1 Lecture - 1

This course explains the uses, selection, safety, and care of industrial power tools: electric drills, electric hammers, pneumatic drills and hammers, screwdrivers, nutrunners, wrenches, linear-motion and circular saws, routers and planes, electric sanders, grinders, and shears. Covers tool sharpening techniques for selected tools.

>APR117G - IMM Apprenticeship Industrial Safety and Health

Credits - 1 Lecture - 1

This course covers government involvement in ensuring a safe workplace. Discusses safety in various situations, personal protective equipment and fire safety. Includes expanded coverage of many health hazards. Covers environmental responsibility and the importance of maintaining a safe work environment.

>APR117H - IMM Apprenticeship Troubleshooting Skills

Credits - 1 Lecture - 1

This course explores the subject of troubleshooting and the importance of proper maintenance procedures. Covers working with others, aids in communication, and trade responsibilities. Outlines troubleshooting techniques and aids, using schematics and symbols. Focuses on specific maintenance tasks, breakdown maintenance, and planned maintenance.

APR Apprenticeship

>APR117I - IMM App. Industrial Rigging Principles and Practices

Credits - 1 Lecture - 1

This course covers techniques and safeguards in the use of rope, chain, hoists, and scaffolding when moving heavy plant equipment and maintaining plant utilities.

>APR117J - IMM Apprenticeship Equipment Installation

Credits - 1 Lecture - 1

This course covers installation procedures for large plant equipment. Considers factors affecting proper installation in detail, from preparatory relocation of underground piping and wiring through equipment anchoring, aligning and running tests.

>APR117K - IMM Apprenticeship Basic Mechanics

Credits - 1 Lecture - 1

This course covers force and motion, work and energy, and fluid mechanics as applied in industrial maintenance. Explains principles of operation for simple machines, such as lever, inclined plane, wheel and axle, pulley, and screw. Explains the basic elements of industrial machines, as well as common measurement tools used to monitor and adjust equipment. Covers hand tools, power tools and fasteners, ending with a discussion of ways to reduce friction and wear.

>APR117L - IMM Apprenticeship Lubricants and Lubrication

Credits - 1 Lecture - 1

This course covers a complete lubrication training program, including functions and characteristics of lubricants, factors in selection of lubricants, and effects of additives, oils, greases, and other compounds used for lubrication are described, as well as their applications. Lubrication methods and recommended storage and handling procedures are included.

>APR117M - IMM Apprenticeship Power Transmission Equipment

Credits - 1 Lecture - 1

This course covers belt drives, chain drive, gears and gear drives, adjustable-speed drives, shaft alignment, shaft coupling devices, and clutches and brakes.

>APR117N - IMM Apprenticeship Bearings

Credits - 1 Lecture - 1

This course covers principles and applications of various types of bearings, including plain journal, ball, and roller bearings. Explains installation, inspection and repair of bearings. Deals with specialized bearings, including powdered-metal, nonmetallic, and hydrostatic bearings. Covers bearing seals, lubrication, and maintenance practices.

APR Apprenticeship

>APR117O - IMM Apprenticeship Pumps

Credits - 1 Lecture - 1

Covers typical applications of various types of pumps. Describes factors affecting pump selection. Explains operating principles of centrifugal, propeller, and turbine, rotary, reciprocating, and metering pumps. Includes special-purpose pumps, diaphragm pumps, and others designed to handle corrosive and abrasive substances. Covers pump maintenance, packing gland, seal, and bearing replacement.

>APR117P - IMM Apprenticeship Piping Systems

Credits - 1 Lecture - 1

Covers piping and tubing systems used for fluid transport in the plant: hydraulic fluids, steam, liquefied product, refrigerant, and water. Shows typical metallic and nonmetallic piping systems, pipe-joining methods, and how tubing and hoses differ from piping. Covers valves, pipe fittings, hangers, supports, and insulation, and shows how tubing is sized, fitted, bent, and joined. Explains uses of traps, filters, and strainers.

>APR117Q - IMM Apprenticeship Basic Hydraulics

Credits - 1 Lecture - 1

This course covers hydraulic principles, types of hydraulic fluids and their characteristics. Describes components of hydraulic systems and their functions; including filters and strainers, reservoirs and accumulators, pumps, piping, tubing and hoses, control valves, and devices. The course also covers a variety of cylinders and hydraulic motors.

>APR117R - IMM Apprenticeship Hydraulic Troubleshooting

Credits - 1 Lecture - 1

This course covers understanding hydraulic systems, using schematic diagrams, installation procedures, cleanliness and safety. Includes tubing cutting, bending, and flaring, identification and selection of proper fluid, and charging the system. Discusses planned maintenance, specific repair/replacement recommendations, system diagnosis, and troubleshooting.

>APR117S - IMM Apprenticeship Basic Pneumatics

Credits - 1 Lecture - 1

This course covers how work, force, and energy are applied to principles of pneumatics. Explains the operating principles of reciprocating, positive displacement, rotary, and dynamic air compressors. Covers primary and secondary air treatment including; valves, logic, devices, cylinders, and air motors.

Symbols:

* - Discipline Studies	^ - Elective
@ - Computer Literacy	+ - Lab Science
~ - Cultural Awareness	> - C/T Elective

Course Descriptions

APR

Apprenticeship

>APR117T - IMM Apprenticeship Pneumatic Troubleshooting

Credits - 1 Lecture - 1

This course covers pneumatic systems, schematic symbols and diagrams, installing system components, planned maintenance, system diagnosis, and troubleshooting. The course also includes maintenance of air compressors, control valves, air motors, electrical components, and hybrid systems.

>APR117U - IMM Apprenticeship Chemical Hazards

Credits - 1 Lecture - 1

This course covers OSHA'S Hazard Communication Standard and discusses the physical and health hazards presented by dangerous chemicals. The student will also be introduced to the information contained in a Material Safety Data Sheet (MSDS).

>APR117V - IMM Apprenticeship Bulk Handling Conveyors

Credits - 1 Lecture - 1

This course covers OSHA'S Hazard Communication Standard and discusses the physical and health hazards presented by dangerous chemicals. The student will also be introduced to the information contained in a Material Safety Data Sheet (MSDS).

>APR210G - Plumbing Apprenticeship Residential Installation

Credits - 4 Lecture - 4

This course will introduce the plumbing apprentice to the broad variety of fixtures (tubs, showers, toilets, water heaters etc.) and fixture fittings (faucets, valves, trim, regulators, gauges) found in residential, commercial and industrial building and instruct the apprentice in the Code requirements and industry practices for proper use and installation.

>APR210H - Plumbing Apprenticeship Commercial Installation

Credits - 4 Lecture - 4

This course will allow the apprentice to master more complex mathematical calculations encountered in the trade; understand the principles of heat transfer and heat retention in connection with water heaters; and understand methods of water treatment as it applies to the Plumbing trade.

>APR210I - Plumbing Apprenticeship Code

Credits - 4 Lecture - 4

In this course, the Plumbing apprentice will master the concepts and procedures of reading a complete set of plans; basic electricity; installation of storm drains; and the Uniform Plumbing Code as it relates to the Plumbing industry.

APR

Apprenticeship

>APR210J - Plumbing Apprenticeship Industrial Installation

Credits - 4 Lecture - 4

In this course the Plumbing apprentice will gain proficiency in; service and maintenance of residential, commercial and industrial plumbing primarily focusing on industrial plumbing installation and repair; and associated Uniform Plumbing Codes for industrial installations.

>APR210K - Plumbing Apprenticeship Basic Waste Water System

Credits - 4 Lecture - 4

This course will enable the Plumbing apprentice to gain proficiency in isometric drawings to depict sizing in water, drainage and gas piping systems; direct, indirect and special waste system; protection of water supply - sources of possible contamination, prevention devices and practices; principles of hydraulics and pneumatic related to plumbing; pump theory - installation and maintenance; developing shop drawings and figuring materials for a job.

>APR210L - Plumbing Apprenticeship Code and Test Preparation

Credits - 4 Lecture - 4

This course covers the review of the Uniform Plumbing Code designed to assist the apprentice with various aspects of taking and passing the Oregon Plumbing License exam.

>APR211G - LMPE Apprenticeship Safety and Code

Credits - 4 Lecture - 4

This course covers the technical knowledge of the skills required of an LMPE Electrician. Content will cover applied electrical theory, residential and commercial wiring practices, busways, motor fundamental application National Electrical Code.

>APR211H - LMPE Apprenticeship Motors and Controls

Credits - 4 Lecture - 4

This course will allow the LMPE Electrical apprentice to understand the technical knowledge of the skills required including motors, generators, controls, and applicable National Electrical Code.

>APR211I - LMPE Apprenticeship Fiber Optics

Credits - 4 Lecture - 4

This course covers applied electrical theory, fiber optics, specialty applications, residential and commercial wiring practices, busways, motor fundamentals, and applicable National Electrical Code for electrical installations.

APR

Apprenticeship

>APR211J - LMPE Apprenticeship Math/Test Equipment

Credits - 4 Lecture - 4

This course covers related training for LMPE Electrician apprentice. Content includes trade history, safety and first aid, blueprint reading, commercial and residential calculations, wiring methods, related theory and National Electrical Code.

>APR211K - LMPE Apprenticeship Voltage

Credits - 4 Lecture - 4

This course covers a thorough review of the National Electrical Code book. Theory and application of motor controls, solid state fundamentals, special termination, layout, hazardous locations and transformer locations.

>APR211L - LMPE Apprenticeship Code and Test Prep

Credits - 4 Lecture - 4

This course covers the review of the National Electrical Code designed to assist the apprentice with various aspects of taking and passing the Oregon State Limited Manufacture Plant Electrical License exam.

>APR212G - Inside Electrical Apprenticeship Safety and Code

Credits - 4 Lecture - 4

This course covers the technical knowledge of the skills required of an Inside Wire Electrician. Content will cover applied electrical theory, residential and commercial wiring practices, busways, motor fundamental application National Electrical Code.

>APR212H - Inside Electrical Apprenticeship Motors and Controls

Credits - 4 Lecture - 4

This course will allow the apprentice to understand the technical knowledge of the skills required including motors, generators, controls, and applicable National Electrical Code.

>APR212I - Inside Electrical Apprenticeship Fiber Optics

Credits - 4 Lecture - 4

This course covers applied electrical theory, fiber optics, specialty applications, residential and commercial wiring practices, busways, motor fundamentals, and applicable National Electrical Code for electrical installations.

>APR212J - Inside Electrical Apprenticeship Math/Test Equipment

Credits - 4 Lecture - 4

This course covers related training for Inside Wire Electrician apprentice. Content includes trade history, safety and first aid, blueprint reading, commercial and residential calculations, wiring methods, related theory and National Electrical Code.

Symbols:

* - Discipline Studies ^ - Elective
@ - Computer Literacy + - Lab Science
~ - Cultural Awareness > - C/T Elective

APR Apprenticeship

>APR212K - Inside Electrical Apprenticeship Voltage

Credits - 4 Lecture - 4

This course covers a thorough review of the National Electrical Code book. Theory and application of motor controls, solid state fundamentals, special termination, layout, hazardous locations and transformer locations.

>APR212L - Inside Electrical Apprenticeship Code and Test Prep

Credits - 4 Lecture - 4

This course covers the review of the National Electrical Code designed to assist the apprentice with various aspects of taking and passing the Oregon State Electrical License exam.

>APR214D - PLC Apprenticeship Operation

Credits - 4 Lecture - 4

This course covers related training for Programmable Logic Controller (PLC) apprentices to study theory and trade practices content focused on automatic control systems, accuracy, errors, pressure measurement and measurement principles.

>APR214E - PLC Apprenticeship Troubleshooting

Credits - 4 Lecture - 4

This course covers related training for Programmable Logic Controller (PLC) apprentice to study theory and trade practices with content focused on compensation, temperature measurement, pneumatic principles and control valves, automatic control and troubleshooting the system.

>APR214F - PLC Apprenticeship Practicle Applications

Credits - 4 Lecture - 4

This course covers related training for Programmable Logic Controller (PLC) apprentices to study theory and trade practices with content focused on calibration, errors, control valves, and special programmable controller functions.

>APR215D - LME Apprenticeship Safety and Code

Credits - 4 Lecture - 4

This course covers the technical knowledge of the skills required of an LME Electrician. Content will cover applied electrical Theory, residential and commercial wiring practices, busways, motor fundamental application National Electrical Code.

APR Apprenticeship

>APR215E - LMPE Apprenticeship Motors and Controls

Credits - 4 Lecture - 4

This course will allow the LME Electrical apprentice to understand the technical knowledge of the skills required including motors, generators, controls, and applicable National Electrical Code.

>APR215F - LME Apprenticeship Code and Test Prep

Credits - 4 Lecture - 4

This course covers the review of the National Electrical Code designed to assist the LME Electrical apprentice with various aspects of taking and passing the Oregon State Limited Maintenance Electrical License exam.

>APR217A - IMM Apprenticeship Maintenance of Mechanical Drives

Credits - 1 Lecture - 1

This course covers mechanical drive alignment, coupling alignment and includes installation and maintenance of mechanical drives, from chain drives to enclosed gear drives.

>APR217B - IMM Apprenticeship Mechanical and Fluid Drive Systems

Credits - 1 Lecture - 1

This course covers further details of drive maintenance, including brakes, clutches, and adjustable-speed drives. APR217B also covers maintenance and troubleshooting of fluid drives and package drive systems.

>APR217C - IMM Apprenticeship Bearing & Shaft Seal Maintenance

Credits - 1 Lecture - 1

This course covers industrial drive maintenance, including brakes, clutches, and adjustable-speed drives. APR217C also covers maintenance and troubleshooting of fluid drives and package drive systems for industrial equipment and machinery.

>APR217D - IMM Apprenticeship Pump Installation and Maintenance

Credits - 1 Lecture - 1

This course introduces the Industrial Maintenance Mechanic apprentice to basic industrial machinery pumping concepts and the required maintenance of packing and seals. APR217D also covers the maintenance and overhaul of centrifugal and rotary pumps.

APR Apprenticeship

>APR217E - IMM Apprenticeship Maintenance Pipe Fitting

Credits - 1 Lecture - 1

This course covers components and terminology used in industrial piping systems including measurement and maintenance of threaded, welded and plastic piping systems. APR217E also explains the use of pipefitting accessories, supports, traps, expansion joints, filters and strainers.

>APR217F - IMM Apprenticeship Tubing & Hose System Maintenance

Credits - 1 Lecture - 1

This course covers industrial tubing installation and specifications. APR217F explores the procedures used for handling, bending, cutting and installing tubing in an industrial setting.

>APR217G - IMM Appr Valve Maintenance & Piping System Protection

Credits - 1 Lecture - 1

This course covers the maintenance and operation of piping valves in an industrial facility. APR217G also introduces actuators and various piping accessories. Explains valve selection based on application and describes methods of protecting industrial piping systems.

>APR217H - IMM Apprenticeship Force and Motion

Credits - 1 Lecture - 1

This course covers fundamentals of force and motion. APR217H demonstrates how mathematical and graphical representations can help clarify our thinking about mechanical force and motion.

>APR217I - IMM Apprenticeship Introduction to Robotics

Credits - 1 Lecture - 1

This course covers the background for a detailed study of robot maintenance. APR217I introduces the apprentice to the basics of robotics, using clear, easy-to-follow language to take the mystery out of robot technology.

>APR217J - IMM Apprenticeship Welding Principles

Credits - 1 Lecture - 1

This course covers fundamentals of welding, discusses welding safety considerations and precautions. APR217J also covers oxyfuel and arc welding equipment, welding techniques and symbols.

>APR217K - IMM Apprenticeship Oxyfuel Operations

Credits - 1 Lecture - 1

This course covers the welding of ferrous and nonferrous metals. APR217K also introduces the student to oxygen cutting, brazing, soldering, and surfacing techniques.

Symbols:

* - Discipline Studies ^ - Elective
 @ - Computer Literacy + - Lab Science
 ~ - Cultural Awareness > - C/T Elective

Course Descriptions

APR

Apprenticeship

>APR217L - IMM Apprenticeship Arc Welding Operations

Credits - 1 Lecture - 1

This course covers shielded metal arc welding, selecting electrodes for SMAW, gas metal and tungsten arc welding. APR217L also includes preheating and reheating of metals, welding nonferrous metals, pipe welding, hard facing and rebuild welding.

>APR217M - IMM Apprenticeship Basic Electricity and Electronics

Credits - 1 Lecture - 1

This course covers a basic nonmathematical approach to understanding principles of electricity. APR217M introduces electron theory, static electricity, electrons in motion, and magnetism, including basic methods of measuring current, voltage, and resistance. The course will introduce the student to circuit components-conductors, insulators, resistors, capacitors and simple Ohm's Law calculations for DC and AC circuits.

>APR217N - IMM Apprenticeship Electrical Safety and Protection

Credits - 1 Lecture - 1

This course examines electrical hazards and stresses the importance of electrical safety when working in an industrial facility. APR217N covers the equipment and procedures necessary to work safely with electricity, including personal protective equipment, lockout/tagout procedures, grounding, fuses, circuit breakers, and motor protection devices and their use.

>APR217O - IMM Apprenticeship How Power Plants Work

Credits - 1 Lecture - 1

This course covers the basic steam generation system, how thermal energy is converted into electrical energy, components of the system, and design features for gaining thermal efficiency. APR217O includes handling of water, fuel, and wastes, and the operating features of a power plant.

>APR217P - IMM Apprenticeship Introduction to Packaging

Credits - 1 Lecture - 1

This course covers the job of packaging mechanic. It provides detail of the major types of packaging machinery including various mechanical drives, couplings, motors, brakes, variable speed drives, clutches, electrical controls, motor starters, event sequencing controls, and packaging.

APR

Apprenticeship

>APR217Q - IMM Apprenticeship Packaging Machinery

Credits - 1 Lecture - 1

This course covers operating and servicing various types of packaging machinery. APR217Q studies different types of liquid filling machines, positive displacement fillers, filling, sealing machines, as well as volumetric filling machines and blister packaging machines.

>APR217R - IMM Apprenticeship Casing Machinery

Credits - 1 Lecture - 1

This course covers the operating characteristics and service techniques of accessory or auxiliary machines used with packaging lines. APR217R examines general operating characteristics of labeling equipment, uncasing, unscrambling, and cleaning machines. The course concludes by introducing the student to gluing equipment and adhesives, wrapping machines, tying, strapping, stitching machines, and shrink wrap devices.

>APR217S - IMM Apprenticeship Programmable Logic Controllers

Credits - 1 Lecture - 1

This course covers the basic operating principles of all Programmable Logic Controllers PLCs including; inputs and outputs, programming, maintenance, and networking.

>APR217T - IMM Apprenticeship Machine Shop Practices

Credits - 3 Lecture - 3

This course covers the principles of machining, measurement, tool grinding, and machine shop safety. In addition, APR217T covers the major types of lathes and their attachments, safety, maintenance, job preparation and basic lathe operations.

ART

Art

*ART101 - Introduction to Visual Arts

Credits - 4 Lecture - 4

Addresses seeing, experiencing, and appreciating the world through architecture, gardens, fountains, and public spaces. Examines how communities express the values, technology, geography, and economic structure of many different cultures in the light of aesthetic, historic, and critical factors.

Prerequisite: WR115 or Placement

NOTE: Prerequisite is for spring term only; WR060 or placement winter term.

Term(s) Offered: Fall

ART

Art

*ART102 - Introduction to Visual Arts

Credits - 4 Lecture - 4

Addresses painting and sculpture in terms of experiencing, appreciating, and understanding their role in our lives. Art is examined in the light of aesthetic, historic, and critical issues.

Prerequisite: WR115 or Placement

NOTE: Prerequisite is for spring term only; WR060 or placement winter term.

Term(s) Offered: Winter

*ART103 - Introduction to Visual Arts

Credits - 4 Lecture - 4

Addresses issues relating to design in our daily lives including commercial, industrial, crafts, and product design. Examines how design expresses the values, technology, economy, and taste of our culture in light of aesthetic, historic, and critical factors.

Prerequisite: WR115 or Placement

NOTE: Prerequisite is for spring term only; WR060 or placement winter term.

Term(s) Offered: Spring

*ART115 - Basic Design

Credits - 4 Lecture - 3 Other - 1

The hands-on study of composition, structure and arrangements of various components for all aesthetic creation. An important foundation class for any designer. Emphasis given to the elements and principles of design learned by practical applications through experimentation in a variety of medium and art forms.

Prerequisite: WR115 or Placement

NOTE: Prerequisite is for spring term only; WR060 or placement winter term.

Term(s) Offered: Fall

*ART116 - Basic Design

Credits - 4 Lecture - 3 Other - 1

A non-sequential course exploring more medium and art forms in learning the fundamentals of arrangements for art and design creations, this course features hands-on study of composition, structure and arrangements of various components for all aesthetic creation. An important foundation class for any designer. Emphasis given to the elements and principles of design learned by practical applications through experimentation in a variety of medium and art forms.

Prerequisite: WR115 or Placement

NOTE: Prerequisite is for spring term only; WR060 or placement winter term.

Term(s) Offered: Winter

Symbols:

* - Discipline Studies ^ - Elective
@ - Computer Literacy + - Lab Science
~ - Cultural Awareness > - C/T Elective

ART

Art

*ART117 - Basic Design

Credits - 4 Lecture - 3 Other - 1

A non-sequential course exploring more medium and art forms in learning the fundamentals of arrangements for art and design creations, this course features hands-on study of composition, structure and arrangements of various components for all aesthetic creation. An important foundation class for any designer. Emphasis given to the elements and principles of design learned by practical applications through experimentation in a variety of medium and art forms.

Prerequisite: WR115 or Placement

NOTE: Prerequisite is for spring term only; WR060 or placement winter term.

Term(s) Offered: Spring

*ART131 - Beginning Drawing

Credits - 4 Lecture - 3 Other - 1

A studio hands-on experience introducing basic procedures, media, and styles in drawing. Subject matter including people, animals, still life, and landscape will be experienced. Guidelines and steps on how to draw an image including shading, establishing perspective, and accurate portions are presented.

Prerequisite: WR115 or Placement

NOTE: Prerequisite is for spring term only; WR060 or placement winter term.

Term(s) Offered: Fall

*ART132 - Beginning Drawing

Credits - 4 Lecture - 3 Other - 1

A non-sequential course featuring hands-on experience introducing basic procedures, media, and styles in drawing. Subject matter including people, animals, still life, and landscape will be experienced. Guidelines and steps on how to draw an image including shading, establishing perspective, and accurate portions are presented.

Prerequisite: WR115 or Placement

NOTE: Prerequisite is for spring term only; WR060 or placement winter term.

Term(s) Offered: Winter

*ART133 - Beginning Drawing

Credits - 4 Lecture - 3 Other - 1

A non-sequential course featuring hands-on experience introducing basic procedures, media, and styles in drawing. Subject matter including people, animals, still life, and landscape will be experienced. Guidelines and steps on how to draw an image including shading, establishing perspective, and accurate portions are presented.

Prerequisite: WR115 or Placement

NOTE: Prerequisite is for spring term only; WR060 or placement winter term.

Term(s) Offered: Spring

ART

Art

*ART154 - Beginning Ceramics

Credits - 4 Lecture - 3 Other - 1

Introduction to the materials, methods and techniques of pottery design and construction.

Prerequisite: WR115 or Placement

NOTE: Prerequisite is for spring term only; WR060 or placement winter term.

*ART155 - Beginning Ceramics

Credits - 4 Lecture - 3 Other - 1

An introduction to the materials, methods and techniques of pottery design and construction.

Prerequisite: WR115 or Placement

NOTE: Prerequisite is for spring term only; WR060 or placement winter term.

*ART156 - Beginning Ceramics

Credits - 4 Lecture - 3 Other - 1

An introduction to the materials, methods and techniques of pottery design and construction.

Prerequisite: WR115 or Placement

NOTE: Prerequisite is for spring term only; WR060 or placement winter term.

*ART184 - Beginning Watercolor

Credits - 4 Lecture - 3 Other - 1

Methods, materials, composition, and techniques using aqueous media.

Prerequisite: WR115 or Placement

NOTE: Prerequisite is for spring term only; WR060 or placement winter term.

*ART185 - Watercolor

Credits - 4 Lecture - 3 Other - 1

A course featuring methods, materials, composition, and techniques using aqueous media.

Prerequisite: WR115 or Placement

NOTE: Prerequisite is for spring term only; WR060 or placement winter term.

*ART186 - Watercolor

Credits - 4 Lecture - 3 Other - 1

A course featuring methods, materials, composition, and techniques using aqueous media.

Prerequisite: WR115 or Placement

NOTE: Prerequisite is for spring term only; WR060 or placement winter term.

^ART198 - Special Studies

Credits - 1-3

Individualized study in areas not considered in other courses to meet special interest or program requirements. Complete a term project approved by the instructor.

Course is repeatable up to 2 times. (2-6 credits total.) Recommended preparation: Prior study and instructor approval.

ART

Art

*ART204 - History of Western Art

Credits - 4 Lecture - 4

This course is a historical survey of the visual arts in the western world from pre-historic times up to the High Renaissance, including ancient Near East, Egypt, Greece, Rome, Early Christian and Byzantine eras, Romanesque, Gothic, Early and High Renaissance.

Prerequisite: WR115 or Placement

NOTE: Prerequisite is for spring term only; WR060 or placement winter term.

*ART205 - History of Western Art

Credits - 4 Lecture - 4

This course is a historical survey of the visual arts in the western world (predominantly Europe) from the 16th Century through the 20th Century. It will include the following styles and developments: Mannerism, 16th Century Painting and Printmaking in Northern Europe, Baroque, Rococo, Neoclassicism, Romanticism, Realism, Impressionism, Post-Impressionism, Fauvism, Expressionism, Cubism, Futurism, Dada, Surrealism, Abstract Expressionism and other 20th century developments.

Prerequisite: WR115 or Placement

NOTE: Prerequisite is for spring term only; WR060 or placement winter term.

*ART231 - Intermediate Drawing

Credits - 4 Lecture - 3 Other - 1

A studio hands-on experience extending basic procedures, media, and styles in drawing from that learned in ART 131. Subject matter including people, animals, still life, and landscape will be experienced. Guidelines and steps on how to draw an image including shading, establishing perspective, and accurate portions are presented.

Prerequisite: WR115 or Placement

NOTE: Prerequisite is for spring term only; WR060 or placement winter term.

Term(s) Offered: Fall

*ART232 - Intermediate Drawing

Credits - 4 Lecture - 3 Other - 1

A studio hands-on experience extending basic procedures, media, and styles in drawing from that learned in ART 132. Subject matter including people, animals, still life, and landscape will be experienced. Guidelines and steps on how to draw an image including shading, establishing perspective, and accurate portions are presented.

Prerequisite: WR115 or Placement

NOTE: Prerequisite is for spring term only; WR060 or placement winter term.

Term(s) Offered: Winter

Symbols:

* - Discipline Studies ^ - Elective
 @ - Computer Literacy + - Lab Science
 ~ - Cultural Awareness > - C/T Elective

Course Descriptions

ART

Art

*ART233 - Intermediate Drawing

Credits - 4 Lecture - 3 Other - 1

A studio hands-on experience extending basic procedures, media, and styles in drawing from that learned in ART 133. Subject matter including people, animals, still life, and landscape will be experienced. Guidelines and steps on how to draw an image including shading, establishing perspective, and accurate portions are presented.

Prerequisite: WR115 or Placement

NOTE: Prerequisite is for spring term only; WR060 or placement winter term.

Term(s) Offered: Spring

*ART254 - Intermediate Ceramics

Credits - 4 Lecture - 3 Other - 1

A continuation of ART 154 in the introduction to the materials, methods and techniques of pottery design and construction at the intermediate level.

Prerequisite: WR115 or Placement

NOTE: Prerequisite is for spring term only; WR060 or placement winter term.

*ART255 - Intermediate Ceramics

Credits - 4 Lecture - 3 Other - 1

A non-sequential continuation of ART 155 in the introduction to the materials, methods and techniques of pottery design and construction at the intermediate level.

Prerequisite: WR115 or Placement, ART 154

NOTE: Prerequisite is for spring term only; WR060 or placement winter term.

*ART256 - Intermediate Ceramics

Credits - 4 Lecture - 3 Other - 1

A non-sequential continuation of ART 156 in the introduction to the materials, methods and techniques of pottery design and construction at the intermediate level.

Prerequisite: WR115 or Placement, ART154 or ART155

NOTE: Prerequisite is for spring term only; WR060 or placement winter term.

*ART261 - Beginning Photography

Credits - 4 Lecture - 3 Other - 1

Black and white photographic processes and techniques; development of camera and darkroom skills; seeing photographically.

Prerequisite: WR115 or Placement

NOTE: Prerequisite is for spring term only; WR060 or placement winter term.

ART

Art

*ART262 - Digital Photo Imaging

Credits - 4 Lecture - 3 Other - 1

Studio course introducing the concepts, techniques, practices, aesthetics, and ethics of photographic imaging and image making with digital technologies. Includes experimentation with the camera and the digital darkroom. Methods include capturing, color correcting and balancing, retouching, layering, masking, composition, and output for printing or digital media presentation.

Prerequisite: WR115 or Placement

NOTE: Prerequisite is for spring term only; WR060 or placement winter term.

*ART263 - Beginning Photography

Credits - 4 Lecture - 3 Other - 1

A non-sequential course continuing to introduce and reinforce the concepts, techniques, practices, aesthetics, and ethics of photographic imaging and image making with digital technologies. Includes experimentation with the camera and the digital darkroom. Methods include capturing, color correcting and balancing, retouching, layering, masking, composition, and output for printing or digital media presentation.

Prerequisite: WR115 or Placement

NOTE: Prerequisite is for spring term only; WR060 or placement winter term.

*ART264 - Intermediate Photography

Credits - 4 Lecture - 3 Other - 1

Intermediate black and white photographic processes and techniques; seeing development of camera and darkroom skills; seeing photographically.

Prerequisite: WR115 or Placement

NOTE: Prerequisite is for spring term only; WR060 or placement winter term.

*ART265 - Intermediate Photography

Credits - 4 Lecture - 3 Other - 1

A non-sequential course continuing the intermediate black and white photographic processes and techniques; further development of camera and darkroom skills; seeing photographically.

Prerequisite: WR115 or Placement

NOTE: Prerequisite is for spring term only; WR060 or placement winter term.

*ART266 - Intermediate Photography

Credits - 4 Lecture - 3 Other - 1

A non-sequential course continuing the intermediate black and white photographic processes and techniques; further development of camera and darkroom skills; seeing photographically.

Prerequisite: WR115 or Placement

Instructor approval required. NOTE: Prerequisite is for spring term only; WR060 or placement winter term.

ART

Art

*ART276 - Beginning Sculpture

Credits - 4 Lecture - 3 Other - 1

A hands-on introduction to studio sculpture through exploring various styles, techniques, and materials of three-dimensional artistic creation. Experiences also include mold making and casting.

Prerequisite: WR115 or Placement

NOTE: Prerequisite is for spring term only; WR060 or placement winter term.

Term(s) Offered: Fall

*ART277 - Beginning Sculpture

Credits - 4 Lecture - 3 Other - 1

A non-sequential course featuring the hands-on introduction to studio sculpture through exploring various styles, techniques, and materials of three-dimensional artistic creation. Experiences also include mold making and casting.

Prerequisite: WR115 or Placement

NOTE: Prerequisite is for spring term only; WR060 or placement winter term.

Term(s) Offered: Winter

*ART278 - Beginning Sculpture

Credits - 4 Lecture - 3 Other - 1

A non-sequential course featuring the hands-on introduction to studio sculpture through exploring various styles, techniques, and materials of three-dimensional artistic creation. Experiences also include mold making and casting.

Prerequisite: WR115 or Placement

NOTE: Prerequisite is for spring term only; WR060 or placement winter term.

Term(s) Offered: Spring

*ART281 - Beginning Painting

Credits - 4 Lecture - 3 Other - 1

A hands-on studio introduction to painting in either oils or acrylic. Exploration in many techniques, styles, and subjects. Includes information on color theory and beginning paint mixing procedures.

Prerequisite: WR115 or Placement

NOTE: Prerequisite is for spring term only; WR060 or placement winter term.

Term(s) Offered: Fall

*ART282 - Beginning Painting

Credits - 4 Lecture - 3 Other - 1

A non-sequential course featuring hands-on studio introduction to painting in either oils or acrylic. Exploration in many techniques, styles, and subjects. Includes information on color theory and beginning paint mixing procedures.

Prerequisite: WR115 or Placement

NOTE: Prerequisite is for spring term only; WR060 or placement winter term.

Term(s) Offered: Winter

Symbols:

* - Discipline Studies ^ - Elective
 @ - Computer Literacy + - Lab Science
 ~ - Cultural Awareness > - C/T Elective

ART

Art

*ART283 - Beginning Painting

Credits - 4 Lecture - 3 Other - 1

A non-sequential course featuring hands-on studio introduction to painting in either oils or acrylic. Exploration in many techniques, styles, and subjects. Includes information on color theory and beginning paint mixing procedures.

Prerequisite: WR115 or Placement

NOTE: Prerequisite is for spring term only; WR060 or placement winter term.

Term(s) Offered: Spring

*ART284 - Intermediate Painting

Credits - 4 Lecture - 3 Other - 1

A non-sequential course featuring hands-on studio introduction to painting in either oils or acrylic. Exploration in many techniques, styles, and subjects. Includes information on color theory and beginning paint mixing procedures.

Prerequisite: WR115 or Placement

NOTE: Prerequisite is for spring term only; WR060 or placement winter term.

Term(s) Offered: Fall

*ART285 - Intermediate Painting

Credits - 4 Lecture - 3 Other - 1

A non-sequential course featuring hands-on studio introduction to painting in either oils or acrylic. Exploration in many techniques, styles, and subjects. Includes information on color theory and beginning paint mixing procedures.

Prerequisite: WR115 or Placement

NOTE: Prerequisite is for spring term only; WR060 or placement winter term.

Term(s) Offered: Winter

*ART286 - Intermediate Painting

Credits - 4 Lecture - 3 Other - 1

A non-sequential course featuring hands-on studio introduction to painting in either oils or acrylic. Exploration in many techniques, styles, and subjects. Includes information on color theory and beginning paint mixing procedures.

Prerequisite: WR115 or Placement

NOTE: Prerequisite is for spring term only; WR060 or placement winter term.

Term(s) Offered: Spring

*ART291 - Intermediate Sculpture

Credits - 4 Lecture - 3 Other - 1

A non-sequential course continuing the ART 278 skills at the intermediate level featuring the hands-on introduction to studio sculpture through exploring various styles, techniques, and materials of three-dimensional artistic creation. Experiences also include mold making and casting.

Prerequisite: WR115 or Placement

NOTE: Prerequisite is for spring term only; WR060 or placement winter term.

Term(s) Offered: Fall

ART

Art

*ART292 - Intermediate Sculpture

Credits - 4 Lecture - 3 Other - 1

A non-sequential course continuing the ART 278 skills at the intermediate level featuring the hands-on introduction to studio sculpture through exploring various styles, techniques, and materials of three-dimensional artistic creation. Experiences also include mold making and casting.

Prerequisite: WR115 or Placement

NOTE: Prerequisite is for spring term only; WR060 or placement winter term.

Term(s) Offered: Winter

*ART293 - Intermediate Sculpture

Credits - 4 Lecture - 3 Other - 1

A non-sequential course continuing the ART 278 skills at the intermediate level featuring the hands-on introduction to studio sculpture through exploring various styles, techniques, and materials of three-dimensional artistic creation. Experiences also include mold making and casting.

Prerequisite: WR115 or Placement

NOTE: Prerequisite is for spring term only; WR060 or placement winter term.

Term(s) Offered: Spring

^ART298 - Special Studies

Credits - 1-3

Advanced, individualized study in areas not considered in other courses to meet special interests or program requirements. Complete a term project approved by the instructor.

Course is repeatable up to 2 times.(2-6 credits total.)

BA

Business Technologies

^BA101 - Introduction to Business

Credits - 4 Lecture - 4

Introduction to business organization, operation, marketing, management, and finance. Course is designed to help students choose their field of major concentration.

Term(s) Offered: Fall, Winter, Spring

>BA104 - Business Mathematics

Credits - 4 Lecture - 4

A study of banking applications, fractions, percentages, payrolls, commissions, trade and cash discounts, markup, simple interest, notes and interest variables, and charges for credit.

Prerequisite: MTH025

Term(s) Offered: Fall, Winter

>BA105 - Business Mathematics

Credits - 4 Lecture - 4

A study of inventories, depreciation, financial statement analysis, stocks and bonds, compound interest, present and future value.

Prerequisite: BA104

Term(s) Offered: Winter, Spring

BA

Business Technologies

>BA106 - Supervision of Table Games

Credits - 4 Lecture - 4

This course covers basic casino managerial techniques with an emphasis on protection of casino games, staffing, labor management relations, floor pit and shift supervision, along with credit and market control, cash and chip control and internal control forms.

Term(s) Offered: Winter

>BA107 - Survey of Gaming Regulations

Credits - 4 Lecture - 4

A survey of the laws and regulations related to the gaming industry. Specific emphasis on the industry and development of Nevada gaming laws, regulations and compliance requirements of gaming licensees. Gaming laws can vary within types of organizations. This course provides a basic foundation to gaming laws overall. Each state/entity will have similar requirements.

Term(s) Offered: Winter

>BA108 - Slots Management I

Credits - 4 Lecture - 4

This course covers basic slots management techniques with an emphasis in supervision of slot shift managers, mechanics, floor persons, change persons, booth cashiers, carousel attendants, coin room managers, count room, jackpot, fills and credit.

Term(s) Offered: Spring

>BA109 - Academic Planning: Business Technologies

Credits - 1 Lecture - 1

This course covers pathways to gaining a particular Business Technologies certificate or degree from BMCC. Included will be tools to help students determine their learning style and personality type. Students will take business career assessments, write goals, and create a business degree-related academic plan that will facilitate their progress toward the goals. Hindrances to academic progress will also be addressed.

Term(s) Offered: Fall

>BA110A - Business Computer Application/MS Access

Credits - 3 Lecture - 2 Other - 1

Basic application and utilization of MS Access database software to solve business computing problems. Focus will include designing and building a database, applying queries, creating reports, using forms, and advanced printing.

Recommended preparation: BA131 and BT120

Term(s) Offered: Winter, Spring

Symbols:

* - Discipline Studies ^ - Elective
@ - Computer Literacy + - Lab Science
~ - Cultural Awareness > - C/T Elective

Course Descriptions

BA Business Technologies

>BA110X - Business Computer Applications/MS Excel

Credits - 3 Lecture - 2 Lab - 1

Basic application and utilization of MS Excel spreadsheet software to solve business computing problems. Focus will include developing a worksheet, changing formats/appearance, using formulas, creating charts, and advanced printing.

Recommended preparation: BA131 and MTH025

Term(s) Offered: Fall, Winter, Spring

>BA111 - Basic Accounting

Credits - 4 Lecture - 3 Other - 1

Provides a basic understanding of debits and credits and financial statements for service enterprises and merchandising businesses.

Term(s) Offered: Fall, Winter

>BA113 - Credit Procedures

Credits - 3 Lecture - 3

Principles of consumer and commercial credit management. Covers types of credit instruments, sources of information, collection, and control.

>BA116 - Bookkeeping Practice

Credits - 2 Other - 2

A hands-on practice set designed to give the student experience with current accounting software.

Prerequisite: BA212

Term(s) Offered: Winter

@^BA131 - Introduction to Business Computing

Credits - 4 Lecture - 3 Lab - 1

General orientation to computer operations and literacy, along with an insight into the broad impact of computers and their uses in today's society. The fundamentals of using the Microsoft Windows operating system, email, web browsers, word processing, spreadsheets, and databases will be developed through hands-on use in the computer lab.

Recommended preparation: BT120

Term(s) Offered: Fall, Winter, Spring

>BA155 - Introduction to Fraud Examination

Credits - 3 Lecture - 3

An introduction to how and why occupational fraud is committed, how fraudulent conduct can be deterred, and how allegations of fraud should be investigated and resolved.

Term(s) Offered: Fall, Winter

BA Business Technologies

>BA177 - Payroll Accounting

Credits - 4 Lecture - 3 Other - 1

Introduction to personnel and payroll records, including all current federal and state payroll taxes. Provides ample practice in preparation of payroll records by hand and by using a computerized payroll accounting software.

Recommended preparation: Accounting class

Term(s) Offered: Winter

>BA190 - Money Management

Credits - 1 Lecture - 1

The class will cover the basics of managing money such as budgeting, controlling expenses, understanding interest rates, compounding of interest, and rates of return. We will also cover a different topic each week including bank accounts, credit cards, loans, mutual funds, stock market, retirement accounts, and real estate.

^BA198 - Special Studies

Credits - 1-3

Designed to provide interested and capable students with the opportunity to study special topics in business areas.

^BA206 - Principles of Management

Credits - 4 Lecture - 4

Principles of management and their applications in organization, administration, and production in the business environment.

Prerequisite: WR060 or WR065

Term(s) Offered: Winter, Spring

>BA207 - E-Commerce

Credits - 4 Lecture - 4

This is a comprehensive 4-credit course designed to prepare the business professional for a challenging role in today's national and international online markets.

>BA209A - Accounting Applications

Credits - 3 Lecture - 2 Other - 1

Completion of accounting practice sets varying from simple to complex on the computer using Peachtree software.

>BA209P - Accounting Applications/Payroll

Credits - 4 Lecture - 2 Other - 2

Completion of payroll accounting practice sets varying from simple to complex on the computer using Peachtree and/or QuickBooks software.

Recommended preparation: Accounting class with a "C" or better.

BA Business Technologies

>BA209Q - Accounting Applications/QuickBooks

Credits - 3 Lecture - 2 Other - 1

Computerized accounting using QuickBooks software, an integrated computerized accounting package relating to service and merchandising businesses.

Recommended preparation: Accounting class with a "C" or better.

Term(s) Offered: Winter, Spring

>BA210 - Microcomputer Applications - Advanced Excel

Credits - 3 Lecture - 2 Lab - 1

Advanced application and utilization of MS Excel program software to solve business problems by modeling advanced spreadsheets commonly used in the business world.

Prerequisite: BA110X

Term(s) Offered: Fall, Spring

^BA211 - Principles of Accounting

Credits - 4 Lecture - 3 Other - 1

Introduction to accounting including techniques of account construction, preparation of financial statements, application of accounting principles to practical business problems, and proprietorship studies.

Term(s) Offered: Fall, Winter

^BA212 - Principles of Accounting

Credits - 4 Lecture - 3 Other - 1

Introduction to accounting including techniques of account construction, preparation of financial statements, application of accounting principles to practical business problems, and proprietorship studies. Emphasis is on corporations and managerial accounting.

Prerequisite: BA211

Term(s) Offered: Winter, Spring

^BA213 - Principles of Accounting

Credits - 4 Lecture - 3 Other - 1

Introduction to accounting including techniques of account construction, preparation of financial statements, application of accounting principles to practical business problems, and proprietorship studies with emphasis on managerial accounting.

Prerequisite: BA212

Term(s) Offered: Fall, Spring

Symbols:

* - Discipline Studies ^ - Elective
@ - Computer Literacy + - Lab Science
~ - Cultural Awareness > - C/T Elective

BA Business Technologies

^BA214 - Business Communications

Credits - 3 Lecture - 3

Concepts and skills necessary to write clean, concise business prose including letters, memos, and reports for standard business uses. Some time is also devoted to oral communications relevant to the business community. The purpose of this course is to help students develop skills to write clean, concise business correspondence and to enter the job market with the appropriate skills knowledge. The course will emphasize skills applicable to both the job search and on-the-job skills.

Prerequisite: WR121

(BT121 or typing/word processing skills strongly recommended)

Term(s) Offered: Winter, Spring

^BA215 - Cost Accounting

Credits - 4 Lecture - 3 Other - 1

The design and development of cost systems, cost analysis, and management use of cost information.

Prerequisite: BA213

Term(s) Offered: Winter

>BA220 - Tax Accounting

Credits - 4 Lecture - 3 Other - 1

Designed to assist students in becoming proficient in preparing federal and State of Oregon individual tax returns. Upon successful completion of this course and BA 221, students will meet the state educational requirements for the Oregon Licensed Tax Preparer's test.

Term(s) Offered: Fall, Spring

>BA221 - Accounting Problems/Tax

Credits - 4 Lecture - 3 Other - 1

This course focuses on Oregon state income tax return preparation, as well as, Oregon law pertaining to licensed tax preparation and consulting. Furthermore, advanced federal tax issues are covered. Combined with BA220 this class completes the 80-hour requirement needed to sit for the licensure exam administered by the Oregon State Board of Tax Practitioners.

A continuation of BA220

Term(s) Offered: Fall

>BA222 - Finance

Credits - 3 Lecture - 3

This course covers an introduction to financial markets in which funds are traded, the institutions which participate in and facilitate these flows of funds and principles, and concepts of financial management which guide the student in making sound financial decisions.

BA Business Technologies

^BA223 - Principles of Marketing

Credits - 4 Lecture - 4

General survey of the nature and role of marketing with emphasis on products, pricing, distribution, and promotion.

Prerequisite: WR060 or WR065

Term(s) Offered: Winter, Spring

>BA224 - Human Resources Management

Credits - 3 Lecture - 3

Introduction to the field of human resources management covering staffing, wage and salary administration, fringe benefits, training and orientation, testing and evaluation, labor relations and unions, and personnel research.

Term(s) Offered: Fall, Winter, Spring

>BA225 - Introduction to Gaming Management

Credits - 4 Lecture - 4

This course will cover an overview of the casino. Topics will include the economics of the casino in addition to its interface with the hotel, organizations, and terminology.

This course is not recommended for people who have worked in the gaming industry.

Term(s) Offered: Fall, Spring

^BA226 - Business Law

Credits - 4 Lecture - 4

The origins of law; the relations of business to society and the law; the evolution of business within the framework of the law, and the development and present-day applications of the law to contracts, sales, and agencies.

Prerequisite: WR060 or WR065

Term(s) Offered: Fall, Winter, Spring

>BA238 - Personal Selling

Credits - 3 Lecture - 3

General sales techniques involving successful personal selling of goods, services, or ideas which includes discussion of motives, sales psychology, prospecting for customers, and sales techniques.

>BA239 - Retail Promotion

Credits - 3 Lecture - 3

A general survey of the field of retail promotion including the study of retail advertising, display, layout, and the selection of appropriate media.

>BA249 - Retail Selling

Credits - 3 Lecture - 3

General sales techniques involving the factors of successful selling of retail goods and services including retail buying motives, sales psychology, customer approach, and retail sales techniques.

Term(s) Offered: Winter, Spring

BA Business Technologies

>BA251 - Office Management

Credits - 3 Lecture - 3

Introduction to the field of office management covering problems in staffing, training, work standards, layout of offices, supervision, pay and benefits, working conditions, and staff motivation.

>BA261 - Intermediate Accounting

Credits - 4 Lecture - 3 Other - 1

Continues the study of accounting principles, the theory underlying the determination of income, and the presentation of financial statements.

Prerequisite: BA213

Term(s) Offered: Winter

>BA262 - Intermediate Accounting

Credits - 4 Lecture - 3 Other - 1

Continues the study of accounting principles, the theory underlying the determination of income, and the presentation of financial statements.

>BA263 - Intermediate Accounting

Credits - 4 Lecture - 3 Other - 1

Continues the study of accounting principles, the theory underlying the determination of income, and the presentation of financial statements.

>BA265 - Accounting Problems

Credits - 4 Lecture - 3 Other - 1

An advanced course dealing with accounting problems in the areas of partnership, branch offices, and governmental accounting.

>BA268 - Introduction to Auditing

Credits - 3 Lecture - 3

Basic principles and procedures of the examination of financial statements as well as the principles involved in obtaining audit proofs applicable to any audit functions.

Prerequisite: BA261

Term(s) Offered: Spring

>BA271 - Analyzing Financial Statements

Credits - 3 Lecture - 3

Includes accounting characteristics of financial statements and the analysis of each component.

>BA277 - Business Ethics

Credits - 3 Lecture - 3

Ethical aspects and practices of business and professional organizations and their employees including a brief introduction to traditional theories of ethics.

Prerequisite: WR060 or WR065

Term(s) Offered: Fall, Spring

Symbols:

* - Discipline Studies	^ - Elective
@ - Computer Literacy	+ - Lab Science
~ - Cultural Awareness	> - C/T Elective

Course Descriptions

BA Business Technologies

^BA280 - Cooperative Work Experience

Credits - 1-8

Provides an experience in the business work environment. A maximum of 12 credits can be earned in any one school year.

Term(s) Offered: Fall, Winter, Spring

>BA284 - Pre-Employment Seminar

Credits - 1 Lecture - 1

Designed to assist the student in résumé and cover letter preparation, interviews, application forms, employment searches, and helpful techniques in obtaining, holding, and advancing in a job.

Term(s) Offered: Winter, Spring

^BA285 - Human Relations in Business

Credits - 3 Lecture - 3

Designed to develop effective human relations in the workplace including: achieving a deepened sense of awareness of self and others, interpersonal communication skills, motivation, valuing diversity, and organizational politics.

Term(s) Offered: Fall, Winter, Spring

>BA295 - Professional Bookkeeping Review

Credits - 3 Lecture - 2 Lab - 1

This course is designed to prepare the student for the American Institute of Professional Bookkeeper's certification. The course consists of five areas of focus: correcting of errors, adjusting entries, payroll, depreciation and inventory. Students are expected to have experience and knowledge of these accounting areas and can use the course to refresh and supplement existing knowledge in preparation for the exam.

Term(s) Offered: Spring

^BA298 - Special Studies

Credits - 1-3

Provides interested and capable students the opportunity to study special topics in the field of business.

BI Science

BI080 - Anatomy and Physiology

Credits - 3 Lecture - 3

Anatomy and Physiology is the study of the structures of the body and how these structures normally function. Emphasis is on a systemic approach to the study of human anatomy and physiology.

Symbols:

* - Discipline Studies ^ - Elective
 @ - Computer Literacy + - Lab Science
 ~ - Cultural Awareness > - C/T Elective

BI Science

+BI101 - General Biology

Credits - 4 Lecture - 3 Lab - 1

A survey course in biological science which fulfills the laboratory science requirement for non-science majors. Topics include biochemistry, cells, genetics, and evolution.

Prerequisite: MTH025 or Placement and RD090 or Placement

Term(s) Offered: Fall, Winter

+BI102 - General Biology

Credits - 4 Lecture - 3 Lab - 1

A part of the general biology sequence. Topics covered include: cell physiology, classification of viruses, bacteria, protists, fungi and plants, and plant anatomy and physiology.

Prerequisite: MTH025 or Placement and RD090 or Placement

Need not be taken in sequence.

Term(s) Offered: Winter, Spring

+BI103 - General Biology

Credits - 4 Lecture - 3 Lab - 1

A part of the general biology sequence. Topics covered include animal taxonomy, physiology, behavior, and ecology.

Prerequisite: MTH025 or Placement and RD090 or Placement

Need not be taken in sequence.

Term(s) Offered: Winter, Spring

+BI124 - Global Ecology and Conservation Biology

Credits - 4 Lecture - 3 Lab - 1

Introduction to ecology including a multidisciplinary investigation of the ways humans interact with habitats worldwide.

Course fulfills the laboratory science requirement for non-science majors.

Prerequisite: MTH025 or Placement and RD090 or Placement

*BI149 - Human Genetics

Credits - 3 Lecture - 3

An introductory lecture course in genetics with emphasis on human aspects. Topics include cellular basis of genetics, Mendelian inheritance, evolutionary genetics, and the molecular basis of inheritance.

Prerequisite: MTH025 or Placement and RD090 or Placement

Offered fall term. Mandatory for nursing program

Term(s) Offered: Fall

^BI160 - Local Ecosystems

Credits - 1 Lab - 1

An introductory field ecology course with emphasis placed on the safe, ethical and educational study of unique ecosystems. Emphasis will be on relationships among plants, animals and the general geologic formation of various life zones.

BI Science

^BI161 - Ecosystems Recovery

Credits - 2 Lecture - 1 Lab - 1

An introductory field ecology course with emphasis on the safe, ethical and educational study of ecosystems recovery. Fieldwork centers around the effects of subsequent natural ecological succession and reclamation projects, as well as on relationships among plants, animals and the general geologic formation of various life zones.

+BI162 - Selected Topics in Natural History

Credits - 4 Lecture - 3 Lab - 1

The course covers the field study of natural environments.

Instructor approval required. The course may be repeated for credit with different subtitles. The specific title of the course offered in any given term will be listed in the class schedule.

+BI163 - Natural History of Oregon

Credits - 4 Lecture - 3 Lab - 1

Introduction to Oregon's biogeographic provinces. The organisms, communities, geology, and the interactions of these to form the different provinces will be studied. Extended field trips will be taken.

Instructor approval required. Offered

^BI198 - Special Studies

Credits - 1-3

Provides interested and capable students the opportunity to study special topics in the field of biology.

+BI211 - General Biology

Credits - 5 Lecture - 4 Lab - 1

A class designed for students majoring in the biological and allied science areas. Topics are cell anatomy and physiology, genetics, and evolution.

Prerequisite: MTH025 or Placement and WR115 or Placement

Recommended corequisite: CH121 or CH221

Term(s) Offered: Fall

+BI212 - General Biology

Credits - 5 Lecture - 4 Lab - 1

Subjects covered are evolution, animal taxonomy, anatomy & physiology, behavior and ecology.

Prerequisite: MTH025 or Placement and WR115 or Placement

Need not be taken in sequence.

Term(s) Offered: Winter

BI Science

+BI213 - General Biology

Credits - 5 Lecture - 4 Lab - 1

Course deals with taxonomy of bacteria, viruses, protists, fungi and plants, plant anatomy and physiology, and ecology.

Prerequisite: MTH025 or Placement and WR115 or Placement

Need not be taken in sequence.

Term(s) Offered: Spring

+BI231 - Human Anatomy and Physiology

Credits - 4 Lecture - 3 Lab - 1

A study of the structures of the systems of the human organism. Systems emphasized include the skeletal, muscular cardiovascular, urinary, and digestive systems.

Prerequisite: CH104 or higher

Recommended Prerequisite: CH110

Term(s) Offered: Fall, Winter

+BI232 - Human Anatomy and Physiology

Credits - 4 Lecture - 3 Lab - 1

The functional aspects of the human organism are emphasized. Topics include neuron function, skeletal muscle physiology, cardiovascular physiology, and transport mechanisms.

Prerequisite: BI231

Term(s) Offered: Winter, Spring

+BI233 - Human Anatomy and Physiology

Credits - 4 Lecture - 3 Lab - 1

A study of the structure and function of prokaryotic and eukaryotic cells. Topics include: reproduction, protein synthesis, enzymology, and immune functions.

Prerequisite: BI232

Term(s) Offered: Fall, Spring

+BI234 - Microbiology

Credits - 4 Lecture - 3 Lab - 1

An introductory course in microbiology, with emphasis on anatomy and physiology of bacteria, fungi and viruses, and proper techniques for handling and studying microorganisms.

Term(s) Offered: Fall, Winter, Spring

BOT Science

+BOT221 - Systematic Botany

Credits - 4 Lecture - 3 Lab - 1

An introductory course in plant systematics with emphasis placed on the proficient use of Hitchcock's "Flora of the Pacific Northwest." The recognition characteristics of plant families plus the identification of local plants is stressed in this course. This is a field course.

BT Business Technologies

>BT116 - Office Procedures

Credits - 3 Lecture - 3

An overview of business etiquette, interoffice relations, business customs, routines, tasks and procedures, self-appraisal and careers in the electronic office.

Term(s) Offered: Fall, Spring

>BT120 - Computer Keyboarding

Credits - 2 Other - 2

Touch typing on the computer keyboard on alphabet keys with emphasis on improving the student's speed and accuracy. Students are given individualized skill-building exercises using computer-assisted instruction.

Term(s) Offered: Fall, Winter, Spring

>BT121 - Document Processing I

Credits - 3 Lecture - 2 Other - 1

This is a beginning course designed for the beginning student. The major objectives of this course are to build basic speed and accuracy skills; and provide practice in applying those basic skills to the production of letters, reports, tables, memos, forms and other kinds of personal, personal-business, and business communication.

Term(s) Offered: Fall, Winter, Spring

>BT122 - Document Processing II

Credits - 3 Lecture - 2 Other - 1

This course promotes the further development of basic keyboarding skills and emphasizes the production of a wide range of typical business correspondence, tables, reports, and forms from unarranged and rough-draft sources. The jobs students prepare and the formats they use are based on current software practices. Basic desktop publishing is introduced. Skill-building is stressed to increase speed to a minimum of 40 words per minute.

Term(s) Offered: Fall, Winter, Spring

>BT123 - Document Processing III

Credits - 3 Lecture - 2 Other - 1

This course contains a brief review of basic production techniques. Integrated office projects emphasize and provide practice in applying such modern office skills as editing, abstracting, decision-making, setting priorities, following directions, and working under pressure with interruptions. Skillbuilding is continued to increase speed to a minimum of 50 words per minute.

Term(s) Offered: Fall, Winter, Spring

BT Business Technologies

>BT124 - Keyboarding for Speed & Accuracy

Credits - 3 Other - 3

BT124 Keyboarding will help develop your speed and accuracy using a computer. You will use a thoroughly tested skillbuilding program to measure your keyboarding speed and accuracy and to determine any specific keyboarding problems you might have by analyzing diagnostic tests that you will take. This course will help you to meet hiring criteria for words per minute on an employment test.

Term(s) Offered: Fall, Winter, Spring

>BT131 - Legal Office Procedures

Credits - 3 Lecture - 3

This course is a practical, comprehensive course that prepares legal assistant students for the law office environment.

Term(s) Offered: Fall

>BT140 - Business Document Editing

Credits - 3 Lecture - 2 Other - 1

Review of grammar and proofreading skills needed in preparing business documents using word processing software and equipment.

Term(s) Offered: Winter, Spring

>BT201M - Word Processing/MS Word

Credits - 3 Lecture - 2 Other - 1

Basic application and utilization of MS Word software to solve business computing problems. Focus includes creating and formatting documents, editing, merging documents, using columns, and adding graphics.

Term(s) Offered: Fall, Winter, Spring

>BT202M - Word Processing/MS Word

Credits - 3 Lecture - 2 Other - 1

Advanced application and utilization of MS Word software to solve business computing problems. Focus includes collaboration of documents, adding comments, tracking changes, saving versions, completing complex merges, building macros, advanced graphics, and integrating Excel charts, Access tables and PowerPoint slide shows.

Term(s) Offered: Winter

>BT204 - Advanced Word Processing Applications

Credits - 3 Lecture - 2 Other - 1

Advanced training in the use of word processing software. Various business documents are produced using advanced procedures to do more complex merges, text columns, tables with math, macros and graphics as well as editing and formatting using multiple documents in Windows.

Symbols:

* - Discipline Studies ^ - Elective
 @ - Computer Literacy + - Lab Science
 ~ - Cultural Awareness > - C/T Elective

Course Descriptions

BT Business Technologies

>BT206 - Desktop Publishing

Credits - 3 Lecture - 2 Other - 1

Applications of software in basic desktop publishing to create various business and personal documents. Extensive use of fonts and graphics will be used in documents designed and created by the student.

Previous experience in application software strongly recommended.

Term(s) Offered: Spring

>BT220 - Calculating Machines

Credits - 3 Lecture - 2 Other - 1

Operation of electronic printing calculators using touch fingering to do mathematical problems involving addition, subtraction, multiplication, division, percentages, constant factors, multiple factors, accumulation of products and quotients, negative multiplication, exponents, decimal equivalents, and reciprocals.

Term(s) Offered: Fall, Winter, Spring

>BT225 - Machine Transcription

Credits - 2 Other - 2

Development of skills in the transcription of recorded dictation using word processing software to produce mailable business correspondence.

>BT226 - Advanced Machine Transcription

Credits - 2 Other - 2

This course continues building skills in transcription in specialty areas including Civil Engineering, Construction and Landscaping while spotting errors in dictation, correcting dictated errors, revising letters from dictated changes and transcribing letters, memos, tables, reports, etc. Language arts skills will be covered in each chapter. MS Word will be used along with computerized software and equipment for transcribing

A continuation of BT225

>BT230 - Legal Terminology I

Credits - 3 Lecture - 3

This course is a practical, comprehensive course that prepares legal assistant students for the law office environment.

Term(s) Offered: Winter

>BT231 - Legal Transcription

Credits - 3 Lecture - 2 Other - 1

Development of skill in the transcription of recorded legal dictation using word processing software to produce legal documents and correspondence.

Term(s) Offered: Spring

BT Business Technologies

>BT232 - Legal Terminology II

Credits - 3 Lecture - 3

This course emphasizes areas that a legal administrative assistant or paralegal may have to deal with. Subject areas include property ownership, real estate transactions, business ownership, employment law, employment discrimination, bankruptcy, marriage, divorce, estates, trusts, product liability, consumer rights, and cyberspace law.

Prerequisite: BT230

Term(s) Offered: Spring

>BT240 - Records Management

Credits - 3 Lecture - 3

Effective methods and systems of storing and retrieving business information, managerial considerations necessary for an efficient records management program and qualifications needed for a career in records management.

>BT251 - Medical Terminology

Credits - 3 Lecture - 3

This course is an overview of basic medical terminology. Prefixes, suffixes, word roots, combining forms, special endings, plural forms, abbreviations and symbols are included in the content. A programmed learning, word-building system is used to learn word parts that are used to construct or analyze new terms. Emphasis is placed on spelling, definition, usage, and pronunciation.

Term(s) Offered: Fall, Winter, Spring

>BT252 - Medical Terminology

Credits - 3 Lecture - 3

This course presents a continued study of medical terminology based on medical word building principles. Prefixes, suffixes, word roots, combining forms, special endings, plural forms, and abbreviations are included in the content. Additionally, anatomy and physiology, pathology, diagnostic, symptomatic and therapeutic terms, diagnostic and lab tests and procedures, surgical procedures, and pharmacology terms are incorporated into the course. Emphasis is placed on correct spelling, definition, usage, and pronunciation.

Term(s) Offered: Winter, Spring

>BT253 - Medical Transcription

Credits - 3 Other - 3

Introduction to transcription of medical office and hospital records including histories, physicals, radiology and pathology reports, consultations, operative reports, discharge summaries and autopsies.

Prerequisite: BT251, BT252 and WR060 or Placement score of 63 or over

Term(s) Offered: Fall

BT Business Technologies

>BT254 - Medical Transcription

Credits - 3 Other - 3

This is a continued beginning medical transcription course designed to provide students with a working knowledge of the transcription of medical reports. Individual patient case studies will be transcribed. The medical reports include history and physical examinations; radiology, operative, and pathology reports; requests for consultation, death summaries, discharge summaries, and autopsy reports.

Prerequisite: BT253 and WR060 or Placement score of 63 or over

Term(s) Offered: Winter

>BT255 - Medical Transcription

Credits - 3 Other - 3

This course is designed to develop expertise in transcribing medical records in additional specialty areas. Includes background noise and dictation by speakers with foreign accents.

A continuation of BT254

>BT257 - Medical Office Procedures

Credits - 3 Lecture - 2 Other - 1

An office practice simulation designed to emphasize routine medical office procedures including medical vocabulary and spelling, medical ethics, medical telephone procedures, medical records management and medical transcription and coding.

Term(s) Offered: Spring

>BT258 - Medical Insurance Procedures and Coding

Credits - 3 Lecture - 3

Medical insurance records management for private health and accident insurance, Medicare, Medicaid, Workers' Compensation. Emphasizes abstracting information from health records for billing and transfer forms. Includes introductory use of CPT-4 and ICD-9M coding.

Prerequisite: BT251, BT252 and WR060 or Placement score of 63 or over

Term(s) Offered: Spring

>BT290 - Integrated Office Systems

Credits - 3 Lecture - 2 Other - 1

This course includes a simulated office experience for students in a practical application of skills and concepts acquired in all business programs. Microsoft Office software and use of the internet is applied.

A capstone course for students who are completing the final term of a two-year AAS degree.

Term(s) Offered: Spring

CET Engineering Tech/Civil-Drafting

Symbols:

* - Discipline Studies ^ - Elective
@ - Computer Literacy + - Lab Science
~ - Cultural Awareness > - C/T Elective

CET **Engineering Tech/Civil-Drafting**

>CET111 - Introduction to Engineering Technology

Credits - 3 Lecture - 3

An orientation course for engineering technicians presenting the historical development of engineering as a profession and related issues of ethics, careers and licensing. Introduction to problem solving format, dimensional analysis and the hand held calculator through the application of algebra based mathematics.

Co-requisite: MTH025 or higher

Term(s) Offered: Fall, Winter

>CET112 - Computer Aided Drafting

Credits - 3 Other - 3

An introduction to computer aided drafting using AutoCAD software, including design set up, file management, entity creation, and manipulation. Projects will include orthographic projection, sections, dimensioning, and isometric drawings.

Term(s) Offered: Winter, Spring

>CET113 - Advanced Computer Aided Drafting

Credits - 3 Other - 3

Advanced CAD applications utilizing reference files, symbols/cell libraries and work space setup in the development of drawings for civil structural purposes and building projects including buildings, bridges, site plans, subdivisions and highway design projects using the Microstation software.

Prerequisite: CET112

Term(s) Offered: Spring

>CET114 - Introduction to Geographic Information Systems

Credits - 3 Other - 3

An introduction to the fundamentals of geographic information systems (GIS) including a brief history of automated mapping, and basic cartographic principles including map scales/coordinate systems/map projections. Hands on use of computer-based ESRI Software will introduce the concepts of layering data from multiple sources into a coherent system. Applicable to geography, sciences, agriculture, business, and engineering uses.

Prerequisite: CS080 or higher

Term(s) Offered: Spring

>CET145 - Engineering Graphics

Credits - 3 Other - 3

An introduction to design processes, graphical analysis, and solutions using fundamental graphic communication concepts including sketching, lettering, geometric constructions, projection theory, orthographic drawing, dimensioning, sections, and pictorial representation.

Term(s) Offered: Fall

CET **Engineering Tech/Civil-Drafting**

>CET162 - Engineering Materials

Credits - 3 Lecture - 3

Basic properties, behavior and survey of engineering applications of materials.

Prerequisite: MTH070 or higher

Co-requisite: PHY101 or higher

Term(s) Offered: Winter

>CET205 - Structural Drafting

Credits - 3 Other - 3

Layout and detailing of timber, steel, and reinforced concrete structural elements using manual and computer-aided drafting procedures.

Prerequisite: CET112 or CET145

Term(s) Offered: Winter

>CET215 - Contract Documents

Credits - 4 Lecture - 3 Other - 1

Interpreting contract documents emphasizing civil law as it relates to contract administration, plans and specifications, and effects on construction practice.

Term(s) Offered: Winter

>CET222 - Concrete Practices

Credits - 4 Lecture - 3 Lab - 1

A study of the Basics of Concrete relating to the testing of fresh concrete, fundamentals of Mix Design, review of the Basics of Concrete and in-depth investigation of the properties of concrete materials. Instruction includes Absolute Volume Method of Mix Design and the techniques required to meet job site specifications for concrete.

Prepares students for completion of the ACI-Field Testing Technician I and ODOT Quality Control Technician Certification Requirements.

Term(s) Offered: Winter

>CET222A - Concrete Field Testing Technician

Credits - 1 Lecture - 1

A study of the Basics of Concrete relating to the testing of fresh concrete.

Term(s) Offered: Spring

>CET222B - Concrete Control Technician

Credits - 1 Lecture - 1

A study of the Fundamental of Mix Design, review of the Basics of Concrete and in-depth investigation of the properties of concrete materials.

Term(s) Offered: Winter, Spring

CET **Engineering Tech/Civil-Drafting**

>CET222C - Concrete Strength Testing Technician

Credits - 1 Lecture - 1

Students are instructed in the Absolute Volume Method of Mix Design and the techniques required to meet job site specifications for concrete.

Term(s) Offered: Winter

>CET223 - Soil Mechanics

Credits - 3 Lecture - 2 Lab - 1

Introduction to soils as engineering materials. Includes classification, evaluation of various physical properties using index tests, and the engineering significance of those properties. Introduction to foundations and excavations.

Prerequisite: MTH070 or higher

Term(s) Offered: Spring

>CET231 - Structures

Credits - 4 Lecture - 3 Lab - 1

Evaluation of stress-strain relationships as related to engineering materials, with emphasis on timber and steel. Includes analysis of structural members and their connections, torsion on power-transmitting shafts, and centroids and moments of inertia of stress.

Prerequisite: MTH084 or MTH112 or higher and PHY201 and CET162

Term(s) Offered: Winter

>CET235 - Structures

Credits - 4 Lecture - 3 Lab - 1

Design of simple beams and columns utilizing an analysis of stress-strain relationships as related to engineering materials, with emphasis on timber and steel. Analysis of structural members and their connections, torsion on power transmitting shafts, centroids and moments of inertia of stress.

Prerequisite: CET231

Term(s) Offered: Winter

>CET251 - Estimating Construction Costs

Credits - 4 Lecture - 3 Lab - 1

Study of processes related to scheduling, estimating and codes in construction. Includes CPM, Quantity Take-Off, Labor-Time and bidding procedures.

Prerequisite: CET215

Term(s) Offered: Spring

Symbols:

* - Discipline Studies ^ - Elective
 @ - Computer Literacy + - Lab Science
 ~ - Cultural Awareness > - C/T Elective

Course Descriptions

CET Engineering Tech/Civil-Drafting

>CET261 - Hydraulics

Credits - 4 Lecture - 3 Other - 1

Introduction to fluid mechanics with emphasis on basic principles of incompressible fluids and their practical application to fluids at rest, steady flow of liquids in closed conduits and open channels, head losses in pipe flow and flow measuring devices.

Prerequisite: MTH111 or higher

Corequisite: PHY201

Term(s) Offered: Fall

>CET263 - 3-D Computer Aided Drafting

Credits - 3 Other - 3

An advanced course using 3-D CAD environment on the Microstation platform to create solid models of objects and buildings. Includes operations to utilize sheet files, materials, palettes, sectioning tools, and exporting tools.

Prerequisite: CET113

Term(s) Offered: Fall

>CET265 - Hydraulics II

Credits - 4 Lecture - 3 Lab - 1 Other -

This course will provide a second course in incompressible fluid flow. Focus will be on open channel flow, buoyancy, flow measurement and instrumentation.

Prerequisite: CET261 and PHY201

>CET280 - Cooperative Work Experience

Credits - 1-8

Supervised production drafting and related work in governmental and private offices.

Prerequisite: CET145 or CET112

Term(s) Offered: Fall, Winter, Spring

CH Science

+CH104 - Introductory Chemistry

Credits - 5 Lecture - 4 Lab - 1

CH 104 covers measurement, elements, compounds, atoms, molecules, chemical reactions and states of matter.

Prerequisite: MTH070 or placement

First of a three-course sequence.

+CH105 - Introductory Chemistry

Credits - 5 Lecture - 4 Lab - 1

CH105 covers solutions, acid-base chemistry and radioactivity as well as the organic compounds and reactions of the hydrocarbons and alcohols.

Prerequisite: CH104

CH Science

+CH106 - Introductory Chemistry

Credits - 5 Lecture - 4 Lab - 1

CH106 covers the organic compounds and reactions of carboxylic acids, amines and related families as well as major biochemical molecules and processes.

Prerequisite: CH105

+CH110 - Foundations of Chemistry

Credits - 5 Lecture - 4 Lab - 1

CH 110 is a survey of inorganic chemistry, covering measurement and matter, elements and atoms, compounds and molecules, states of matter, solutions, chemical reactions, acids & bases and radioactivity, with an introduction to organic and biochemistry.

Prerequisite: MTH 070 or placement

Term(s) Offered: Fall

+CH221 - General Chemistry

Credits - 5 Lecture - 4 Lab - 1

CH 221 covers measurement and matter, elements and atoms, compounds and molecules, chemical reactions and thermochemistry.

Prerequisite: MTH111

Recommended: 1 year high school or 1 or more terms of college level chemistry.

Term(s) Offered: Fall

+CH222 - General Chemistry

Credits - 5 Lecture - 4 Lab - 1

CH 222 covers atomic structure, chemical bonding, molecular geometry, states of matter and solutions.

Prerequisite: CH221

Term(s) Offered: Winter

+CH223 - General Chemistry

Credits - 5 Lecture - 4 Lab - 1

CH 223 covers kinetics, equilibria including acids and bases, electrochemistry, thermodynamics and nuclear chemistry.

Prerequisite: CH222

Term(s) Offered: Spring

CJ Criminal Justice

^CJ100 - Introduction to Criminal Justice

Credits - 3 Lecture - 3

This course will provide an overview of the types and purpose of law as well as the nature and extent of crime in American society. The focus is on introducing the student to the history, philosophy, and social development of police, courts, and corrections in the United States as a legal response to criminal behavior.

Term(s) Offered: Fall

CJ Criminal Justice

^CJ101 - Careers in Criminal Justice

Credits - 3 Lecture - 3

This course is designed to assist students in identifying potential local, state, and federal career opportunities in the criminal justice system, including law enforcement, courts, and corrections. Students will become familiar with the educational requirements, lifestyle considerations, application processes, testing, screening, training, and certification requirements of employment in the field of criminal justice. Students will solidify their academic plan and prepare a personal career plan based on their goals. Students are strongly encouraged to take this course concurrently or immediately after CJ100. Course is also an accepted alternative to HD109.

Term(s) Offered: Fall, Winter, Spring

^CJ110 - Police Systems and Practices

Credits - 3 Lecture - 3

This course provides an overview and analysis of the American system of law enforcement, examining the origins, development, roles, and operations of policing in a modern democratic society. The focus is on students developing a detailed understanding of law enforcement principles and practices and technological advances in policing.

Term(s) Offered: Winter

^CJ120 - American Court Systems and Practices

Credits - 3 Lecture - 3

This course will introduce students to the role of the judiciary in the criminal justice system by examining the structure and function of both federal and state courts systems in the United States. Topics include jurisdiction, venue, roles of court participants, due process and post arrest procedures employed in adjudication, the grand jury process, types and rules of evidence, sentencing concepts, and appellate review.

Term(s) Offered: Winter

^CJ130 - Correctional Systems and Practices

Credits - 3 Lecture - 3

This course introduces the corrections process, including historical development, current practices, and future considerations of corrections. The course will identify the subcomponents of corrections, variations in correctional institutions, levels of custody, administrative practices, correctional staff roles and responsibilities, institutional policies, procedures, and programs. The course also covers changing inmate demographics, special needs inmates, safety and security concerns, and alternatives to imprisonment.

Term(s) Offered: Spring

Symbols:

* - Discipline Studies ^ - Elective
 @ - Computer Literacy + - Lab Science
 ~ - Cultural Awareness > - C/T Elective

CJ Criminal Justice

^CJ132 - Probation and Parole: Systems and Practices

Credits - 3 Lecture - 3

This course provides an overview of community-based corrections, focusing primarily on probation and parole processes, and how each function plays an integral role in the criminal justice system. Topics addressed include the historical and philosophical foundations of probation and parole, evidence-based best practices in the management of reducing risk in the community and the administration of probation and parole services at the federal, state, and local levels.

Term(s) Offered: Spring

^CJ198 - Special Studies

Credits - 1-3

Designed to provide interested and capable students with the opportunity to study special topics in criminal justice.

^CJ200 - Theories of Crime and Delinquency

Credits - 3 Lecture - 3

This course is an in-depth analysis of major theories of crime and delinquency from various sociological, psychological, and biological perspectives. The course will also examine how criminal acts are measured, the development of criminal careers, the various typologies of offenders and victims, and a critical analysis of public policies concerning crime prevention and control in a democratic society.

Prerequisite: WR121

Term(s) Offered: Fall

^CJ201 - Juvenile Justice

Credits - 3 Lecture - 3

This course gives students an overview of the American juvenile justice system, in terms of both philosophy and practice. It examines the nature, extent, and causes of juvenile delinquency, the juvenile adjudication process, and juveniles remanded to the adult criminal justice system. This course also looks at institutionalization, rehabilitation, the treatment of juveniles, and the future of juvenile justice in America.

Prerequisite: WR121

Recommended: CJ100

Term(s) Offered: Winter

>CJ204 - Behavioral Cognitive Processes

Credits - 4 Lecture - 3 Other - 1

This course is designed to provide an understanding of cognitive processes to changing offender behavior, its role and application with offenders in correctional programming (rehabilitation and recidivism) and how it can effect criminal behavioral change. Laboratory will consist of actual on-site correctional programming.

Symbols:

* - Discipline Studies ^ - Elective
 @ - Computer Literacy + - Lab Science
 ~ - Cultural Awareness > - C/T Elective

CJ Criminal Justice

>CJ205 - Victimology

Credits - 3 Lecture - 3 Lab - Other -

This course examines the relationship between victims of crime, the perpetrators, and the criminal justice system. Topics include the following: an analysis of victimization patterns and characteristics; the role of victims in the adjudication process; the complexities of victim – offender relationships; remedies to victimization such as prevention, legislation, restorative justice, treatment, and restitution; international aspects of victimology; and, future directions for victimology as a field of study. Several victim typologies will be addressed.

Prerequisite: WR121

Recommended: CJ100

>CJ210 - Police and Community

Credits - 3 Lecture - 3

This course examines proactive community-oriented policing and problem solving in the context of changes in law enforcement agencies and communities. This course provides a comprehensive view of how police agencies are changing their management style, organizational structures, and operational strategies in an era of changing community needs, citizen expectations, legal restraints, advancing technology, advocacy groups, and special populations.

Prerequisite: WR121 and CJ110

Recommended: CJ100 and CJ101

Term(s) Offered: Fall

>CJ212 - Criminal Investigation

Credits - 3 Lecture - 3

This course covers the fundamentals of criminal investigation including the gathering of investigative information from victims and witnesses, the search and recording of crime scenes, and the principles involved in collecting and preserving physical evidence. There is a strong emphasis on investigative policies, procedures, and practices that are necessary and essential in preparing such information and evidence for court.

Prerequisite: WR121, CJ110

Recommended: CJ100, CJ101 and CJ210

Term(s) Offered: Winter

^CJ214 - Criminal Justice Report

Credits - 3 Lecture - 3 Lab - Other -

This course will focus on the skills needed to effectively write reports common to criminal justice professions. It provides English grammar and writing skills, with necessary communication skills, including interviewing and interrogation, to help student improve their writing, communication, and observation abilities. As the result of practical exercises and assignments, students will learn to write reports that are complete, clear, accurate and concise.

Prerequisite: CJ100 and WR122 or WR227

Term(s) Offered: Spring

CJ Criminal Justice

^CJ220 - Criminal Law

Credits - 3 Lecture - 3

This course is an examination of substantive criminal law, its philosophical and historical development, major definitions and concepts, principles of criminal liability, classifications and elements of crimes, criminal defenses, and the nature of criminal sanctions.

Prerequisite: WR121

Recommended: CJ100, CJ120

Term(s) Offered: Winter

^CJ222 - Procedural Law

Credits - 3 Lecture - 3

This course focuses on the procedural rights of defendants in the criminal justice system as guaranteed by the U.S. Constitution and how these rights guide the administration of justice.

Prerequisite: WR121

Recommended: CJ100, CJ220

Term(s) Offered: Spring

>CJ225 - Correctional Law

Credits - 3 Lecture - 3

This course examines laws, rules, and standards applicable to correctional institutions and community-based supervision of detained or convicted offenders. It is an overview of constitutional issues, judicial decisions, and legislative actions pertaining to prisons, jails, probation, and parole. The student will assess current case, statutory, and constitutional provisions applicable to the correctional setting.

Prerequisite: WR121

Recommended: CJ100, CJ222

Term(s) Offered: Fall

^CJ227 - Ethics in Criminal Justice

Credits - 3 Lecture - 3 Lab - Other -

This course examines ethical dilemmas and professional problems faced by criminal justice personnel. Students review various ethical perspectives and discuss the practical applicability of ethical philosophies to address ethical and professional conduct in the field of criminal justice.

Prerequisite: WR121

Recommended: CJ100

Term(s) Offered: Spring

>CJ232 - Correctional Casework Counseling

Credits - 3 Lecture - 3

Basic concepts of interviewing and counseling techniques used by correctional officers in one-to-one contacts with clients. Rudimentary skills practiced through role playing and demonstration prepare the student for practice in the field and an appreciation of further training.

Course Descriptions

CJ Criminal Justice

>CJ240 - Crime, Justice and Diversity

Credits - 3 Lecture - 3

This course explores the issues surrounding the operation of a justice system in culturally diverse, democratic society. This course examines the impact of cultural diversity on the American criminal justice system, including a discussion of race and ethnicity; the historical treatment of minorities; cross-cultural communication between criminal justice personnel and diverse populations; criminal and victimization patterns and trends in the context of race, ethnicity, gender, age, sexual orientation; and, strategies for success in making criminal justice agencies more effective in serving diverse communities, including recruitment and hiring of minority populations.

Prerequisite: WR121

Recommended: CJ100

>CJ243 - Narcotics and Dangerous Drugs

Credits - 3 Lecture - 3

This course focuses on the problems created by illegal use of narcotics and dangerous substances, including a historical examination of drug abuse; the nature and extent of drug abuse; etiology of addiction; symptoms and consequences of drug abuse; the intentions and limitations of drug control and regulation efforts; and the impact of drugs on the American criminal justice system.

Prerequisite: WR121

Recommended: CJ100

Term(s) Offered: Fall

>CJ250 - Criminal Justice Administration

Credits - 3 Lecture - 3

This course introduces the student to leadership styles, management principles, supervisory techniques, and policy and procedure formulation in the management of criminal justice agencies with an emphasis on ethical leadership. Students are provided an opportunity to address real criminal justice management issues and problems, and discover ways to resolve them while applying theory to practical situations.

Prerequisite: WR121 and CJ100

Term(s) Offered: Spring

>CJ280 - Cooperative Work Experience

Credits - 1-8

Supervised field experience in a criminal justice or related agency. An in-service student may pursue a research project instead of work in the field. Includes a seminar for discussion of problems and experience gained.

Criminal Justice Coordinator Approval Required

Term(s) Offered: Fall, Winter, Spring

COM Communications

COM Communications

^COM100 - Human Communications

Credits - 4 Lecture - 4

An introductory course that focuses on the process and functions of communication in interpersonal, small group, interview, mass, and intercultural contexts. Emphasis is placed on helping the student increase his/her competence as a communicator in each of these contexts.

Recommended preparation: WR060

Term(s) Offered: Fall, Winter, Spring

*COM111 - Fundamentals of Speech

Credits - 4 Lecture - 4

Fundamentals of preparation and presentation of oral discourse. Emphasis is on informative speaking, and also in-depth introduction to classical rhetorical concepts of persuasive speaking.

Prerequisite: WR115 or Placement

Recommended preparation: NOTE:

Prerequisite is for spring term only; WR060 or placement winter term.

Term(s) Offered: Fall, Winter, Spring

*COM112 - Fundamentals of Speech

Credits - 4 Lecture - 4

Fundamentals of preparation and presentation of oral discourse. Emphasis is on development of skills in group discussions and group problem-solving techniques. Introduction to argumentation.

Prerequisite: WR115 or Placement

NOTE: Prerequisite is for spring term only; WR060 or placement winter term.

~*COM115 - Intercultural Communication

Credits - 4 Lecture - 4

An introductory course that focuses on the impact of culture on the communication process. Emphasis is placed on both understanding cultural diversity and enhancing communication effectiveness in various intercultural contexts.

Prerequisite: WR115 or Placement

NOTE: Prerequisite is for spring term only; WR060 or placement winter term.

Term(s) Offered: Fall, Winter, Spring

~^COM237 - Gender and Communication

Credits - 3 Lecture - 3

This course focuses on the similarities and differences in male and female communication styles and patterns. Particular attention is given to the implications of gender as social construct upon perception, values, stereotypes, language use, nonverbal communication and power and conflict in human relationships. Discusses influences of mass communication upon shaping and constructing male and female sex roles.

CS Math/Computer Science

CS020 - Computer Orientation

Credits - 1 Other - 1

The purpose of the course is to introduce students to computer language and basic computer use with an emphasis on word processing and using e-mail.

Designed for those who have had little or no experience working with computers.

CS080 - Introduction to Personal Computers

Credits - 3 Lecture - 3

The student will examine the applications and use of personal computer hardware and software. The student will be introduced to word processing, e-mail, spreadsheets, and the Internet. Also discussed is basic file management under Windows.

Term(s) Offered: Fall, Winter, Spring

CS090 - Personal Computer Applications

Credits - 3 Lecture - 3

This course will investigate beginning and elementary features and functions of a particular software application.

May be repeated under different topics.

Term(s) Offered: Spring

CS095 - Personal Computer Applications

Credits - 3 Lecture - 3

This course will investigate intermediate to advanced features and functions of a particular software application.

May be repeated under different topics.

@*CS120 - Concepts of Computing

Credits - 4 Lecture - 4

A survey of the general concepts of computers and their applications. Concepts include computer systems, system and applications software, data organization and management, and computers in society. Specific applications with hands-on projects will include word processing, presentation management, spreadsheets, database, graphics, and web authoring.

Term(s) Offered: Fall, Winter, Spring

Symbols:

* - Discipline Studies ^ - Elective
@ - Computer Literacy + - Lab Science
~ - Cultural Awareness > - C/T Elective

CS Math/Computer Science

^CS125 - Software Applications

Credits - 3 Lecture - 3

This class will study in detail one specific software application used with microcomputers. Topics will include standard features and operations of the application and consideration of one or more specific products and their unique features. Course may include (but is not limited to) word processing (CS 125W), spreadsheets (CS 125S), presentation management (CS 125P), multimedia (CS 125M), database management systems (CS 125D), desktop publishing (CS 125B) and e-mail (CS 125E). This course may be repeated under different topics. Offered periodically.

*CS133B - Programming with Visual Basic

Credits - 4 Lecture - 4

An introduction to programming with the high level programming language Visual BASIC. The student will study basic programming styles, techniques and the syntax of Visual BASIC. Students will write, run and debug programs on microcomputers.

*CS133U - Programming with C++

Credits - 4 Lecture - 4

An introduction to programming with the high level programming language C. The student will study basic programming styles, techniques and the syntax of C. Students will write, run and debug programs on microcomputers.

*CS161 - Computer Science

Credits - 4 Lecture - 4

An introduction to problem solving and algorithm design with the use of a high level programming language. Included will be basic principles of hardware, software and programming techniques.

Recommended preparation: MTH111 or equivalent.

*CS162 - Computer Science

Credits - 4 Lecture - 4

Continued introduction to problem solving and algorithm design with the use of a high level programming language. Additional topics may include data organization (multidimensional arrays, records, pointers, lists, stacks and queues) and techniques for designing large projects.

Prerequisite: CS161

^CS179 - Introduction to Networking

Credits - 4 Lecture - 3 Lab - 1

This class introduces the students to basic computer networking concepts. Networking topologies, basic hardware and software components in network, the OSI protocol model, and vocabulary items are presented to the students.

CS Math/Computer Science

^CS180 - Computer Science Practicum

Credits - 4

A course that will allow students to apply what they have learned in some area of computer science to real world situations. Students will work directly with a local business or organization under the direction and supervision of their instructor.

*CS195 - Web Development

Credits - 4 Lecture - 4

A first course in the design and development of Web pages and sites. This course will include the use of Web page authoring tools as well as HTML syntax to create Web pages. Students will study both the mechanics and practical application of these tools as well as principles of good design for the Web.

Recommended preparation: CS120

^CS198 - Special Studies

Credits - 1-3

This course is designed to provide interested and capable students special topics in computer science.

*CS260 - Data Structures

Credits - 4 Lecture - 3 Other - 1

Continued instruction in problem solving and algorithm design with the use of a high level programming language, this course also includes basic data structures, searching and sorting techniques and advanced problem solving.

Prerequisite: CS162

^CS279 - Network Management II

Credits - 4 Lecture - 3 Other - 1

The class introduces the student to Local Area Network Management. Some topics taught in this course include setting up users, directory structures, security issues, printing and print queues, login scripts, and other management tools available for networking administrators. Students will manage a small LAN system with supervisory rights during the tenure of the course.

^CS280 - Cooperative Work Experience

Credits - 1-8

Provides a supervised work experience in computer science which supplements the "school experience" that is not possible in the normal academic classroom environment.

^CS288 - Network Management III

Credits - 4 Lecture - 3 Lab - 1

A course designed to examine different advanced networking topics and current trends in networking. Topics will include items relative to the needs and learning experience of the students.

CS Math/Computer Science

*CS295 - Web Development

Credits - 4 Lecture - 4

A second course in the design and development of Web pages and sites. This course will include JavaScript, CCS, SSI, CGI programming, and other DHTML tools. Students will study both the mechanics and practical application of these tools.

Recommended preparation: CS195

^CS298 - Special Studies

Credits - 1-3

This course is designed to provide interested and capable students special topics in computer science.

CSS Agriculture

>CSS100 - Soils and Fertilizers

Credits - 3 Lecture - 2 Lab - 1

Students will study and evaluate the characteristics of the soil. Soil amendments and fertilizers are reviewed to determine crop requirements. Plant and soil analysis techniques are studied.

Term(s) Offered: Winter

>CSS201 - Principles of Crop Science

Credits - 3 Lecture - 3

Covers the major farm practices used in Eastern Oregon. Major crops used to facilitate learning include wheat, barley, peas, potatoes, and corn. Other crops will be reviewed to determine their adaptability to local climate, soils, and markets.

Corequisite: AGR280

Term(s) Offered: Spring

>CSS210 - Forage Crops

Credits - 3 Lecture - 3

Students will study the various crops raised for livestock consumption. Proper planting, maintenance, harvest, and storage techniques, production and economic returns are topics reviewed in detail.

Corequisite: AGR280

Term(s) Offered: Fall

>CSS240 - Pest Management

Credits - 4 Lecture - 4

Students will study the common pesticides used on today's farms and ranches. Herbicides, insecticides, fungicides, and growth regulators will be reviewed. Methods of application and calibration are taught stressing safety in handling and disposal.

Corequisite: AGR280

Term(s) Offered: Winter

DA Dental Assisting

Symbols:

* - Discipline Studies ^ - Elective
 @ - Computer Literacy + - Lab Science
 ~ - Cultural Awareness > - C/T Elective

Course Descriptions

DA Dental Assisting

>DA141 - Dental Radiology

Credits - 4 Lecture - 3 Lab - 1

Introduces dental radiology concepts including historical background, terminology, principles of dental radiology, legal aspects regarding use of radiation, basic physics associated with x-rays and biological effects of x-rays. Includes practical instruction on and sizes health and safety, infection control procedures, anatomical landmarks, types and sizes of x-ray film, darkroom processing, film mounting, examination and operation of a dental x-ray unit with beginning practice of film placement and exposure techniques on mannequins.

Prerequisite: MTH 025

Admission to the dental program and/or instructor approval.

Term(s) Offered: Fall

>DA142 - Dental Radiology

Credits - 3 Lecture - 2 Lab - 1

Continued study and clinical practice with the principles of dental radiography techniques including: bisecting, paralleling, bitewing, panelipse exposure on adult patients, and other exposure techniques for the edentulous patient. The identification of possible abnormalities seen on a radiograph are viewed and discussed.

Prerequisite: DA141

Term(s) Offered: Winter

>DA143 - Dental Radiology

Credits - 1 Lab - 1

Provides a concentrated clinical application of dental radiographic procedures studied in previous courses in preparation for the Dental Assisting National Board Radiation Examinations.

Prerequisite: DA142

Term(s) Offered: Spring

>DA151 - Chairside Procedures I

Credits - 4 Lecture - 3 Lab - 1

Introduction to and practice of basic chairside assisting procedures including disease transmission, disinfection and sterilization procedures, OSHA compliance procedures, patient preparation, oral evacuation, equipment and instrument identification, instrument transfer, and restorative operative dental procedures.

Admission to the dental program and/or instructor approval.

Term(s) Offered: Fall

DA Dental Assisting

>DA152 - Chairside Procedures

Credits - 3 Lecture - 2 Lab - 1

A presentation of the theory and practice of new procedures and review of oral evacuation, instrument transfer, and infection control procedures. Includes discussion, demonstration, and practical application of the following: alginate impressions, dental dam placement and removal, bite registration, suture removal, introduction to tofflemire matrix and wedge placement, and coronal polish.

Prerequisite: DA151

Term(s) Offered: Winter

>DA153 - Chairside Procedures

Credits - 2 Lecture - 1 Lab - 1

Covers theory and practice of procedural responsibilities delegated to the dental auxiliary as outlined in the current Oregon Dental Practice Act for the Expanded Function Duty Assistant. Includes discussion, demonstration, practical lab experience, and clinical application.

Prerequisite: DA142, 152, 162

Term(s) Offered: Spring

>DA154 - Dental Specialties

Credits - 2 Lecture - 2

Covers various specialties of dentistry and new, emerging technologies, their principal procedures, instrument identification, tray setups, and post-operative care instructions.

Prerequisite: DA151

Term(s) Offered: Winter

>DA162 - Clinical Practice

Credits - 4 Other - 4

Course designed to provide supervised clinical experience in basic chairside assisting procedures, including material manipulation, oral evacuation, instrument transfer, charting, and patient management in a local dental office.

Prerequisite: DA151

Term(s) Offered: Winter

>DA163 - Clinical Practice

Credits - 8 Other - 8

Provides dental assisting students with continued supervised work experience in a dentist's office. Students assist with operative procedures, exposing and processing dental radiographs, dental laboratory procedures, and performing business office procedures.

Prerequisite: DA162

Term(s) Offered: Spring

DA Dental Assisting

>DA166 - Clinical Practice Seminar

Credits - 1 Lecture - 1

Seminar discussions to be held on various aspects of spring term internships in local dental offices. Employment opportunities, résumé writing, completing job applications, and interviewing skills are covered.

Admission to the dental program and/or instructor approval.

Term(s) Offered: Spring

>DA170 - Basic Dental Science

Credits - 3 Lecture - 3

The study of systems of the human body, their physiology, as well as bacteriology and embryology as they relate to the oral cavity.

Admission to the dental program and/or instructor approval.

Term(s) Offered: Fall

>DA172 - Dental Anatomy

Credits - 4 Lecture - 4

An introduction to the oral cavity. Students will identify the supporting structures, differences, and similarities of individual teeth of both primary and permanent dentition. Utilizing various numbering systems, students will gain skill and knowledge of basic charting symbols and procedures. Blacks' Cavity classification and elements of cavity design are introduced.

Admission to the dental program and/or instructor approval.

Term(s) Offered: Fall

>DA174 - Dental Pathology

Credits - 1 Lecture - 1

The study of oral pathology to include normal, diseased, or injured tissues; dental caries; oral inflammation; abscesses, and developmental abnormalities.

Prerequisite: DA170 and DA172

Term(s) Offered: Winter

>DA176 - Dental Pharmacology

Credits - 1 Lecture - 1

General aspects of pharmacology; sources, types, purposes, and composition of the drugs. Course includes methods of prescribing and administering various drugs as well as local anesthetics used by the dentist when treating patients.

Admission to the dental program and/or instructor approval.

Term(s) Offered: Winter

Symbols:

* - Discipline Studies ^ - Elective
 @ - Computer Literacy + - Lab Science
 ~ - Cultural Awareness > - C/T Elective

DA Dental Assisting

>DA180 - Dental Materials

Credits - 3 Lecture - 2 Lab - 1

Introduction, demonstration, manipulation, and principal application including physical and chemical properties, preparation, care and storage of materials used in dental offices.

Admission to the dental program and/or instructor approval.

Term(s) Offered: Fall

>DA182 - Dental Materials and Procedures

Credits - 2 Lecture - 1 Lab - 1

Introduction to a variety of materials used in the dental office for restorative and specialized procedures. The course includes the various materials, physical and chemical properties, preparation, manipulation, care and storage, as well as laboratory equipment identification, use and safety procedures.

Prerequisite: DA151 and DA180

Term(s) Offered: Winter

>DA190 - Dental Health Education

Credits - 2 Lecture - 2

The attitudes, philosophies, and behaviors of the dental patients along with techniques to motivate and manage their various behaviors. Covers basic concepts of preventive dentistry including the study of plaque-related diseases, brushing and flossing techniques, and fluoride therapy. Basic food groups and nutritional counseling are introduced along with techniques for preparing and evaluating dental health education materials.

Admission to the dental program and/or instructor approval.

Term(s) Offered: Fall

>DA192 - Dental Law and Ethics

Credits - 1 Lecture - 1

History, ethics, and legal aspects of dentistry are covered as they are prescribed by the American Dental Association and Oregon Practice Act. Designed to acquaint students with the members of the dental team, their roles, educational background, and legal responsibilities and restrictions.

Prerequisite: DA190

Term(s) Offered: Winter

>DA194 - Dental Business Office

Credits - 2 Lecture - 1 Other - 1

Designed to prepare the student for management of the dental office, including the study of business office procedures and techniques, written communication, computer use, dental insurance, accounts receivable, recall systems, staff and patient management, and inventory control procedures.

Prerequisite: DA162

Term(s) Offered: Spring

DA Dental Assisting

>DA196 - Medical Emergencies in the Dental Office

Credits - 1 Lecture - 1

Emphasizes the importance of the health history, treatment of the medically compromised patient, and the influence a medical emergency may have on the patient during clinical treatment. Signs and symptoms are studied for handling medical emergencies. Course content also includes vital signs and emergency medical equipment usage.

Admission to the dental program and/or instructor approval.

Term(s) Offered: Fall

DSL Diesel/Welding/PTD

>DSL141 - Heavy Duty Steering and Suspension

Credits - 4 Lecture - 3 Lab - 1

This course will prepare the student to diagnose and repair problems with manual and power steering components, suspension systems, steerable tag and drop axles. The course will also train students in preventative maintenance practices for steering and suspension systems and for steering and suspension system alignment.

Term(s) Offered: Fall

>DSL151 - Heavy Duty Brakes I

Credits - 3 Lecture - 2 Other - 2

Hydraulic, air, and mechanical brake system principles of operation, self-energizing, drum, disc, parking, internal expanding, and external band brakes will be covered. Brake system self-adjusters, electric brakes, brake adjustment and inspection will also be covered. Included in this course will also be engine brakes and retarders.

Term(s) Offered: Spring

>DSL152 - Manual Drive Trains I

Credits - 3 Lecture - 2 Lab - 1

Principles and operation of power train components including automotive and industry applications of clutches, drive lines, and gear transmissions. Transmission of force through the mechanism will be studied in theory and in labs. Detailed maintenance and repair of drive lines, clutches, gear transmissions, and transaxles with emphasis on problem diagnosis, repair and replacement.

Term(s) Offered: Winter

>DSL153 - Manual Drive Trains II

Credits - 3 Lecture - 2 Lab - 1

A continuation of DSL 152 covering more detailed maintenance and repair of drive lines, differentials, transfer cases, gear transmissions, and transaxles with emphasis on problem diagnosis, repair and replacement, and repair.

Prerequisite: DSL152

Term(s) Offered: Spring

DSL Diesel/Welding/PTD

>DSL161 - Diesel Engines

Credits - 4 Lecture - 3 Lab - 1

The course provides up-to-date, interactive training through classroom study, use of Internet Website information, and hands-on experience in the "Virtual Workplace" or lab. The course focuses on the history, theory of operation, and principles of design of the diesel engine.

Term(s) Offered: Winter

>DSL162 - Engine Repair I

Credits - 4 Lecture - 3 Lab - 1

This course covers provides up-to-date, interactive training through classroom study, use of Internet Website information, and hands-on experience in the "virtual workplace" or lab, for the troubleshooting, repair, and maintenance of diesel engines. Special focus will be on the performance of the cylinder head, lubrication system, and cooling systems. Students will remove, recondition, and reassemble diesel engines.

Prerequisite: DSL161

Term(s) Offered: Spring

>DSL175 - Heavy Duty Equipment

Credits - 3 Lecture - 2 Lab - 1

This course will focus on off-highway mobile equipment systems. Training will emphasize diagnostics and repair of heavy equipment.

Prerequisite: DSL184

Term(s) Offered: Winter

>DSL176 - Mobile Air-Conditioning and Heating

Credits - 3 Lecture - 2 Lab - 1

This course will introduce the theory of air conditioning and heating systems in mobile equipment. The theory will be followed by diagnostic and repair techniques required by the service technician.

Term(s) Offered: Spring

>DSL181 - Shop Practices

Credits - 3 Lecture - 3

This course trains the student in basic shop environment practices, including personal safety. The course also trains student in proper and safe tool use, along with use of fasteners and hardware employed in the field of diesel technology.

Term(s) Offered: Fall

>DSL184 - Fluid Mechanics

Credits - 4 Lecture - 3 Lab - 1

This course will introduce the theory and application of fluid mechanics. The course expands upon the theory by troubleshooting and repairing on- and off-highway hydraulic systems.

Term(s) Offered: Fall

Symbols:

* - Discipline Studies ^ - Elective
 @ - Computer Literacy + - Lab Science
 ~ - Cultural Awareness > - C/T Elective

Course Descriptions

DSL Diesel/Welding/PTD

>DSL191 - Electrical Systems I

Credits - 4 Lecture - 2 Other - 2

An introductory course designed to provide basic technical knowledge of principles of operation, construction, and purpose of electron theory and basic electrical circuits and components.

Term(s) Offered: Fall

>DSL192 - Electrical Systems II

Credits - 4 Lecture - 2 Other - 2

Provides the basic technical knowledge of electrical circuits, measurement values, circuit components, circuit tracing and diagnosing, and repair of electrical malfunctions.

Prerequisite: DSL191

Term(s) Offered: Winter

>DSL193 - Electrical Systems III

Credits - 4 Lecture - 2 Other - 2

Designed to give the student basic technical knowledge of semiconductors and diodes, including operating principles of starting, charging, and ignition systems.

Prerequisite: DSL192

Term(s) Offered: Spring

>DSL196 - Electronic Diagnostics and Engine Emissions

Credits - 3 Lecture - 2 Lab - 1

This course is designed to introduce the student to the use of electronic control systems in on and off road vehicles. It details subjects from basic electrical wiring and connections to more detailed electronic troubleshooting tools and how engine performance and injection timing can result in non-compliant exhaust emissions. Students will receive hands-on training in the lab setting learning to use ESTs, and proper troubleshooting techniques.

Prerequisite: DSL193

Term(s) Offered: Winter

>DSL200 - Pre-Employment Seminar

Credits - 1 Lecture - 1

This course is designed assist students seeking employment. Job-hunting techniques, interviewing skills, and the study of job-related responsibilities and problems while advancing in a chosen career are among the major topics covered.

Term(s) Offered: Spring

DSL Diesel/Welding/PTD

>DSL251 - Heavy Duty Brakes II

Credits - 3 Lecture - 2 Other - 2

Principles of compressed air, air brake component identification and operation, and air brake valve troubleshooting and service will be covered. This course also includes other heavy duty brake systems for trucks, tractors and heavy equipment; and complete brake jobs, including inspection and service.

Prerequisite: DSL151

Term(s) Offered: Fall

>DSL262 - Engine Repair II

Credits - 4 Lecture - 3 Lab - 1

This course covers provides up-to-date, interactive training through classroom study, use of internet website information, and hands-on experience in the "virtual workplace" or lab, for the troubleshooting, repair, and maintenance of diesel engines. Areas of focus include intake and exhaust systems, turbochargers, engine brakes, and the fuel subsystem.

Prerequisite: DSL162

Term(s) Offered: Fall

>DSL263 - Advanced Engine Technology

Credits - 4 Lecture - 3 Lab - 1

This course covers provides up-to-date, interactive training through classroom study, use of internet website information, and hands-on experience in the "virtual workplace" or lab, of the advanced diagnostics of diesel engines. The class will focus on testing engines after re-build; the operation, testing, and repair of injection pumps and governors; troubleshooting typical engine and fuel-system failures; and the operation and adjustment of a Cummins Pressure-Time system.

Prerequisite: DSL262

Term(s) Offered: Winter

>DSL275 - Heavy Duty Equipment II

Credits - 3 Lecture - 2 Lab - 1

This course will focus on off-highway mobile equipment. Training will emphasize diagnostics and repair of powertrain systems.

Prerequisite: DSL175

Term(s) Offered: Spring

>DSL280 - Cooperative Work Experience

Credits - 1-8

Provides a supervised work experience in diesel mechanics which supplements the "school experience" that is not possible in the normal academic classroom environment.

Term(s) Offered: Winter, Spring

EC Social Science

*EC201 - Principles of Microeconomic Theory with Applications

Credits - 4 Lecture - 4

Introduction to Microeconomics. Focuses on the behavior of individual consumers and business firms and how their interaction leads to a set of prices that act to allocate scarce resources among alternative uses. This course includes applications of microeconomic theory to current economic problems.

Prerequisite: WR115 or Placement, MTH060

Prerequisite is WR060 or placement for Summer and Fall 2012 terms only.

Term(s) Offered: Fall, Spring

*EC202 - Principles of Macroeconomic Theory with Applications

Credits - 4 Lecture - 4

Introduction to Macroeconomics. This course focuses on the behavior of economic aggregates or the economy as a whole. National income determination, measuring economic performance and public policy tools for dealing with inflation, unemployment, etc. are discussed. This course includes applications of microeconomic theory to current economic problems.

Prerequisite: WR115 or Placement, EC201

Prerequisite is WR060 or placement for Summer and Fall 2012 terms only.

Term(s) Offered: Winter

ECE Early Childhood Ed.

>ECE100 - Developmentally Appropriate Practice in Early Childhood Ed

Credits - 3 Lecture - 3

This course covers an overview of developmentally appropriate practice in Early Childhood Programs. Students will become familiar with the standard of care in early childhood education as delineated by the National Association for the Education of Young Children and outlined in the text, Developmentally Appropriate Practice in Early Childhood Programs.

Term(s) Offered: Fall, Winter, Spring

>ECE101 - Family and Community Relations

Credits - 3 Lecture - 3

This course provides the knowledge and skills necessary to work effectively with families and community professionals in early childhood education. Topics to be covered include family involvement, communicating with families and professionalism in early childhood education.

Term(s) Offered: Fall

EC Social Science

^EC198 - Special Studies

Credits - 1-3

This course is designed to provide interested and capable students special topics in economics.

Symbols:

* - Discipline Studies ^ - Elective
@ - Computer Literacy + - Lab Science
~ - Cultural Awareness > - C/T Elective

ECE Early Childhood Ed.

>ECE111 - Introduction to ECE Environments

Credits - 3 Lecture - 3

This course covers the different types of early childhood education programs and the regulations that govern each. Emphasis is on design of early learning environments that support growth and development in all domains of learning: social-emotional, intellectual, and physical. Students will evaluate existing early learning settings and suggest adaptations. Students will apply principles of developmentally appropriate practice to the evaluation and design of early learning environments.

Term(s) Offered: Winter

>ECE112 - Introduction to Early Childhood Education/ Professionalism

Credits - 1 Lab - 1

This course provides students with an opportunity to explore the field of Early Childhood Education through a hands-on, application-oriented experience in an approved Early Care and Education Setting under the supervision of career professionals. Student will also have the opportunity to complete Career-Related Learning Experiences (CRLE), required for graduation from Oregon's high schools.

Term(s) Offered: Fall, Spring

>ECE113 - Introduction to Early Childhood Education/Child Advocacy

Credits - 1 Lecture - 1

This course covers the ethical and legal responsibilities of early childhood practitioners.

>ECE150 - Observation/Assessment and Recording

Credits - 3 Lecture - 3

Students will develop skills necessary to observe, assess and record young children's behavior. Students will gain experience with a variety of observation and recording tools. Focus is on the importance of objective record keeping in relationship to the on-going monitoring of children's development.

Term(s) Offered: Winter

>ECE151 - Guidance and Classroom Management

Credits - 3 Lecture - 3

This introductory course to guidance for young children, ages birth through eight, presents a positive child guidance approach based on principles of developmentally appropriate practice in early care and education, as outlined by the National Association for the Education of Young Children. Students will be provided with research-based, philosophically sound knowledge, research, practices, and strategies that contribute positively to the emotional and social development of the young child.

Term(s) Offered: Fall, Spring

ECE Early Childhood Ed.

>ECE152 - Creativity for Young Children

Credits - 3 Lecture - 3

This course focuses on understanding and implementing developmentally appropriate practices for the young child. Students will gain hands-on experience in multiple creative activities that are age appropriate, individually appropriate and culturally appropriate.

Term(s) Offered: Spring

>ECE153 - Music and Movement

Credits - 3 Lecture - 3

This class provides a foundation for understanding the role of music and movement in the development of young children. Students will have the opportunity to integrate knowledge and experience culminating in a personal collection of developmentally appropriate music and movement activities for young children.

Term(s) Offered: Spring

>ECE154 - Literature and Literacy

Credits - 3 Lecture - 3

This course surveys and presents methods for using and evaluating children's literature. Students will also gain knowledge about the relationship between language development and emergent literacy.

Term(s) Offered: Winter

>ECE175A - Infant/Toddler Caregiving: Social Emotional Growth

Credits - 1 Lecture - 1

This course presents healthy social emotional development in infancy as the underpinning for all other learning and that social emotional development is dependent on the child's close relationship with respectful, caring adults. Also discussed is the importance of understanding temperament, emotions, environmental impact and care giving responsiveness to the child's needs. Students are presented information to promote awareness of their own feelings, expectations and attitudes brought with them from past experiences to the field of early childhood education. Students will examine the relationship between social emotional care giving and services provided to families.

Term(s) Offered: Spring

>ECE175B - Infant/Toddler Caregiving: Group Care

Credits - 1 Lecture - 1

This course helps students to understand how to develop intimacy between infants and others in a group. Students will discuss barriers, as well as discover strategies for providing appropriate care. Respectful routine care in a child's daily life is fundamental to developing intimate relationships. Students will evaluate health and safety issues, daily routine care and consider environment, space and child care ratios as important aspects of group care.

Term(s) Offered: Spring

ECE Early Childhood Ed.

>ECE175C - Infant/Toddler Caregiving: Learning and Development

Credits - 1 Lecture - 1

This course presents a non-traditional view of how infants and toddlers develop. Students will discover the importance of infants and toddlers having the freedom to make learning choices and to experience the world on their own terms. Facilitation of natural interests and urges to learn dominate the course content with specific information based on understanding learning schemes, developmental stages and support for learning.

Term(s) Offered: Spring

>ECE175D - Infant/Toddler Caregiving: Culture, Family and Provider

Credits - 1 Lecture - 1

This course challenges students to articulate their philosophy of infant/toddler care and the caregiver-parent relationship so that they can develop stronger partnerships and facilitate communication with parents. Considerations for how participants can encourage families to participate in their child's care will be discussed and strategies for working with difficult situations explored. The course will also examine common challenges in conducting a child care business to include defining business relationships and arrangements. Family issues around separation, accepting diversity, culture and routine care and culture and child development will be analyzed and practical solutions explored.

Term(s) Offered: Spring

>ECE198 - Special Studies

Credits - 1-3

Designed to provide interested and capable students with the opportunity to study special topics in the Early Childhood Education

>ECE226 - Child Development

Credits - 3 Lecture - 3

This course covers child development from birth through age eight. Focus is on major developmental theories, stages of development and appropriate behavioral expectations. This course is the foundation for the Early Childhood Education program.

Term(s) Offered: Fall, Winter, Spring

>ECE227 - Enhancing Social Emotional Development

Credits - 3 Lecture - 3

This course provides an in-depth exploration of strategies and techniques for enhancing children's social emotional development.

Term(s) Offered: Winter

Symbols:

* - Discipline Studies	^ - Elective
@ - Computer Literacy	+ - Lab Science
~ - Cultural Awareness	> - C/T Elective

Course Descriptions

ECE Early Childhood Ed.

>ECE240 - Curriculum/Planning

Credits - 3 Lecture - 3

This course focuses on designing curriculum for the young child using the principles of developmentally appropriate practice and constructive learning theory. Students will apply the components of constructivism to the design of early childhood curriculum. Application of theory to practice is emphasized.

Term(s) Offered: Spring

>ECE245 - Challenging Behavior in Young Children

Credits - 3 Lecture - 3

This course addresses challenging behavior in young children. Students will explore the causes of and the risk factors associated with challenging behavior. Students will develop knowledge and skills which will allow them to understand, prevent, and respond effectively to challenging behavior.

Term(s) Offered: Spring

>ECE248 - Overview of Special Services

Credits - 3 Lecture - 3

This course introduces students to services for early intervention to young children with special needs. The course also presents current legislation, educational needs of special children and ideas and strategies for working with families to integrate special children into preschool programs.

Term(s) Offered: Spring

>ECE249 - Inclusion of Children with Special Needs

Credits - 3 Lecture - 3

The emphasis of this course is on strategies and adaptations for including children with special needs in the early childhood setting. Current resources and best practices for educating children with diverse abilities, limited English proficiency, different socioeconomic and/or cultural backgrounds and other special needs will be explored.

Term(s) Offered: Fall

>ECE280 - Cooperative Work Experience

Credits - 1-8

The purpose of cooperative work experience is to provide students with an opportunity to gain volunteer experience with young children in an early childhood setting. Students participating in cooperative work experience with young children must successfully complete a criminal history background check. Cooperative work experience may include one-to-one or small group instructional assisting.

Term(s) Offered: Fall, Winter, Spring

ECE Early Childhood Ed.

>ECE295 - Child Care Administration

Credits - 3 Lecture - 3

An exploration of administrative roles and responsibility in child care centers. Topics include philosophy, finances, personnel, legal regulation and program planning.

>ECE296 - Issues and Trends

Credits - 3 Lecture - 3

This course explores the status of early childhood education. The purpose is to assist students in becoming knowledgeable professionals. Topics may include: inclusion, professionalism, teaching methods, brain research, teenage parents and working parents.

Term(s) Offered: Fall

ED Teacher Ed/Ed Assistant

^ED100 - Introduction to Education

Credits - 1 Lecture - 1

This course examines teaching as a profession. It provides opportunities for direct experience with, and analysis of, educational settings. Students will explore current issues in education and characteristics of effective schools.

Required in Elementary & Secondary AAOT transfer degree, AAS degree for Paraeducators and Paraeducator Certificate.

Term(s) Offered: Fall, Winter, Spring

^ED113 - Instructional Strategies in Language Arts

Credits - 3 Lecture - 3

Introduces the nature of the reading process and presents a systematic approach to language arts instruction. Students learn to link literacy instruction and assessment to state content standards.

Required in Paraeducator Certificate and AAS degree.

Term(s) Offered: Fall, Winter

>ED114 - Instructional Strategies in Math and Science

Credits - 3 Lecture - 3

This course introduces the development of math and science concepts and presents a systematic approach to math and science instruction. Students learn to link math and science instruction and assessment to state content standards.

Required in Paraeducator Certificate and AAS degree.

Term(s) Offered: Spring

ED Teacher Ed/Ed Assistant

>ED125 - Peer Tutoring/ED 125

Credits - 1 Lecture - 1

This course is designed to prepare and instruct peer tutors on the principles and skills needed to provide effective tutoring services to students enrolled in various classes throughout the community college campus. Student tutors will gain skills and experience needed to assist tutees by participating in both in-class and out of class activities.

>ED130 - Comprehensive Classroom Management

Credits - 3 Lecture - 3

This course provides current theory and methodology for managing small and large groups of students so that students choose to be productively involved in instructional activities. Covers the four major factors or skill areas of effective classroom management; 1) Understanding students' personal/psychological and learning needs, 2) Establishing positive adult-student and student-student relationships, 3) Implementing instructional methods that facilitate optimal learning, and 4) Using organizational and group management methods that maximize positive student behavior and learning.

Required in Paraeducator Certificate and AAS degree.

Term(s) Offered: Fall

>ED131 - Instructional Strategies

Credits - 3 Lecture - 3

Introduces a variety of teaching techniques and provides practice for students in instructional design. Students plan lessons and teach lessons to small groups of peers or instructional K-12 students and participate in self-evaluation and peer evaluation of others' teaching.

Required in Paraeducator Certificate and AAS degree.

Term(s) Offered: Winter

>ED157 - Introduction to Mathematical Explorations

Credits - 3 Lecture - 3

This course introduces current theory and methodology for creating an active learning environment that fosters curiosity, knowledge and understanding of important mathematical relationships, number sense, and basic problem-solving in an early childhood elementary setting.

Prerequisite: MTH025

Term(s) Offered: Winter

Symbols:

* - Discipline Studies ^ - Elective
 @ - Computer Literacy + - Lab Science
 ~ - Cultural Awareness > - C/T Elective

ED Teacher Ed/Ed Assistant

>ED169 - Overview of Students with Special Needs

Credits - 3 Lecture - 3

An introduction to the disabling conditions of students with special needs and their implications in school settings. Defines and identifies intervention strategies for disabilities covered under federal law.

Required in Paraeducator Certificate and AAS degree.

Term(s) Offered: Spring

^ED200 - Foundations of Education

Credits - 3 Lecture - 3

This course provides an overview of the American Education System, including historical, legal, and philosophical foundations. Students will explore the governance of local schools and districts and will consider the roles and ethical obligations of professional educators.

Prerequisite: WR115 or Placement

Required in Elementary & Secondary AAOT transfer degree, Paraeducator AAS and Certificate degrees

Term(s) Offered: Winter, Spring

^ED229 - Learning and Development

Credits - 3 Lecture - 3

This course addresses current theory regarding human development, intelligence, motivation, and the learning process. Students learn to apply strategies and techniques derived from these theories.

Required in Paraeducator Certificate and AAS degree.

Term(s) Offered: Winter, Spring

@>ED235 - Educational Technology

Credits - 3 Lecture - 3

This course trains students in the preparation and use of media and technology in school settings. Students will develop an understanding of the role of media in learning and methods for incorporating media in instruction.

Term(s) Offered: Winter

>ED250 - Second Language Acquisition

Credits - 2 Lecture - 2

This course will examine all the factors that impact second language acquisition; as well as the issues, theories and practices that are associated with second language learning.

Recommended preparation: WR060

ED Teacher Ed/Ed Assistant

>ED251 - Literacy Development for Second Language Learners

Credits - 3 Lecture - 3

The purpose of this course is to explore researched based best practices for literacy instruction for second language learners. Students will examine English only, native language, and dual language literacy programs.

Recommended preparation: WR060

>ED252 - Technology and Second Language Learners

Credits - 2 Lecture - 2

This course will explore the variety of technology tools and resources used in ESL classrooms to support English language development.

Recommended preparation: WR060

^ED254 - Instructional Strategies for English Language Learners

Credits - 3 Lecture - 3

This course will examine pedagogical and cultural approaches which lead to successful acquisition of English language skills and content knowledge.

Required in Paraeducator Certificate and AAS degree.

Term(s) Offered: Spring

>ED255 - Bilingual Education/ELD Strategies

Credits - 3 Lecture - 3

The purpose of this course is to explore strategies that promote effective English language development for second language learners.

Recommended preparation: WR060

^ED258 - Multicultural Education

Credits - 3 Lecture - 3

This course covers the philosophy, activities, and techniques appropriate to a culturally sensitive classroom. Students will develop an understanding of the impact of culture on individual perception and learning and group dynamics.

Required in Paraeducator Certificate and AAS degree. Will satisfy the Cultural Awareness requirement for the CUESTE program.

Term(s) Offered: Fall, Spring

>ED260 - Overview of Autism Spectrum Disorders

Credits - 3 Lecture - 3

This course provides an overview of Autism Spectrum Disorders from birth to adult. Characteristics, behaviors, theories, and general information will be given with emphasis on research-based evidence.

Prerequisite: WR060

Term(s) Offered: Fall

ED Teacher Ed/Ed Assistant

>ED261 - Instructional Strategies for Autism Spectrum Disorders

Credits - 3 Lecture - 3

This course provides instructional support strategies for k-12 instructional assistants and others who work with students who have Autism Spectrum Disorder. Effective strategies and techniques will be discussed and practices.

Prerequisite: ED260

Term(s) Offered: Winter

>ED262 - Behavior Management for Autism Spectrum Disorders

Credits - 3 Lecture - 3

This course provides effective strategies and techniques for managing the behavior of K-12 students with Autism Spectrum Disorders. Emphasis will be placed on appropriate practices and procedures.

Prerequisite: ED260

Term(s) Offered: Spring

>ED263 - Communication Strategies for Autism Spectrum Disorder

Credits - 3 Lecture - 3

This course covers effective strategies and techniques for fostering communication with the student as well as encouraging communication from the student with Autism Spectrum Disorder. Specific attention will be paid to communication strategies in a K-12 school environment. Effective strategies and techniques will be discussed and practiced.

Prerequisite: ED260

>ED266 - Current Issues in Special Education

Credits - 3 Lecture - 3

This course is designed to provide students interested in special education an opportunity to explore in more depth current issues in special education. Students will be exposed to current philosophical frameworks, legislative changes, emerging conditions, and technological advances.

Elective in Paraeducator Certificate and AAS degree.

>ED268 - Educating Mildly and Severely Handicapped

Credits - 3 Lecture - 3

This course covers the theory and techniques of working with handicapped students. Services and funding provided for mildly and severely handicapped students are studied.

Elective in Paraeducator Certificate and AAS degree

Symbols:

* - Discipline Studies	^ - Elective
@ - Computer Literacy	+ - Lab Science
~ - Cultural Awareness	> - C/T Elective

Course Descriptions

ED Teacher Ed/Ed Assistant

^ED280 - Cooperative Work Experience

Credits - 1-8

The purpose of this education practicum experience is to give first and second year education majors an opportunity to gain volunteer experience with age-appropriate children in an educational setting. Students participating in this practicum must successfully complete a criminal history verification check. Practicum situation may include one-to-one or small group tutoring in reading, math, or other areas in a classroom setting.

Required in Elementary and Secondary AAO transfer degree, AAS and Certificate degrees for paraeducators.

Term(s) Offered: Fall, Winter, Spring

>ED285 - Signing Exact English

Credits - 3 Lecture - 3

Beginning communication in Signing Exact English (SEE). This course introduces Manually Coded English sign language systems, focusing specifically on SEE. It includes the theories, rules, principles, and vocabulary of SEE, as well as practice in both receptive and expressive skills. Students will be introduced to the finger spelled alphabet, as well as appropriate body, facial, and dramatic features of sign language.

Elective in Paraeducator Certificate and AAS degree.

>ED286 - Signing Exact English

Credits - 3 Lecture - 3

This is the second course in a sequence which introduces Manually Coded English sign language systems, focusing specifically on Signing Exact English 2 (SEE). It includes the theory, rules, principles and vocabulary of SEE, as well as practice in both receptive and expressive skills. Students will be introduced to the finger spelled alphabet, as well as appropriate body, facial, and dramatic features of sign language.

Prerequisite: ED285 or instructor approval.

Elective in Paraeducator Certificate and AAS degree.

>ED287 - Signing Exact English

Credits - 3 Lecture - 3

This course is the third course in a sequence of courses which introduces Manually Coded English sign language systems, focusing specifically on Signing Exact English 2 (SEE). It includes the theory, rules, principles, and vocabulary of SEE, as well as practice in both receptive and expressive skills. Students will be introduced to the finger-spelled alphabet, as well as appropriate body, facial, and dramatic features of sign language.

Prerequisite: ED286 or instructor approval.

Elective in Paraeducator Certificate and AAS degree.

ED Teacher Ed/Ed Assistant

>ED298 - Special Studies

Credits - 1-3

This course is designed to accommodate a variety of content and subject areas related to education in the K-12 schools. Coursework will be specific to teaching and learning related activities and strategies. These topics may include, but are not limited to, teaching techniques, instructional technology, human relations, communication, and non-instructional support skills. Most of these courses will be taught in a workshop/conference environment in which students choose topics and issues that are relevant to their specific job responsibilities or are of specific interest to them.

Elective in Paraeducator Certificate and AAS degree.

EMT Emergency Medical Technician

>EMT115 - Crisis Intervention

Credits - 3 Lecture - 3

Provides a theoretical background for understanding crisis intervention and offers an arena to experience a variety of crisis management styles. Assists the emergency service worker or healthcare provider to evaluate their emotional reactions and methods of coping in order to stay healthy on the job.

Term(s) Offered: Spring

>EMT151 - EMT Basic Part A

Credits - 5 Lecture - 5

This course is designed to instruct a student to the level of Emergency Medical Technician-Basic. EMT 151 covers the first half of the National Standard Curriculum. The EMT Basic is a vital link in the chain of the health care team. At the end of this course students will be trained to; 1. Recognize the nature and seriousness of the patient's condition or extent of injuries to assess requirements for emergency medical care. 2. Administer appropriate emergency medical care based on assessment findings of the patient's condition. 3. Lift, move, position, and otherwise handle the patient to minimize discomfort and prevent further injury. 4. Perform safely and effectively the expectations of the job description for an EMT-Basic.

United States Department of Transportation National Highway Traffic Safety Administration EMT-Basic: National Standard Curriculum

Term(s) Offered: Fall

EMT Emergency Medical Technician

>EMT152 - EMT Basic Part B

Credits - 5 Lecture - 5

This course is designed to instruct a student to the level of Emergency Medical Technician-Basic. EMT 152 covers the second half of the National Standard Curriculum. The EMT Basic is a vital link in the chain of the health care team. At the end of this course students will be trained to; 1. Recognize the nature and seriousness of the patient's condition or extent of injuries to assess requirements for emergency medical care. 2. Administer appropriate emergency medical care based on assessment findings of the patient's condition. 3. Lift, move, position, and otherwise handle the patient to minimize discomfort and prevent further injury. 4. Perform safely and effectively the expectations of the job description for an EMT-Basic.

United States Department of Transportation National Highway Traffic Safety Administration EMT-Basic: National Standard Curriculum

Prerequisite: EMT151 or 009.406

Term(s) Offered: Winter

>EMT169 - EMT Rescue

Credits - 3 Lecture - 2 Lab - 1

Presents technical information on various rescue situations. Covers tools and equipment, ropes and knots, trench rescue, shoring, warehouse searches, outdoor searches, rescue in situations involving elevation differences, package patients, water and ice rescues, and vehicle extrication.

Term(s) Offered: Spring

>EMT175 - Intro. To Emergency Medical Services

Credits - 4 Lecture - 4

Intro to EMS explores the philosophy and history of emergency services. Presents the history of loss of life and property in fire, major medical emergencies, and natural disasters. Covers the responsibility of emergency services in a community, the roles and responsibilities of a paramedic and firefighter, an overview of the ICS system, and the organization and function of emergency services and allied organizations, education and certification. Includes sources of professional literature, awareness and identification of hazardous materials, emergency services apparatus, fire behavior, detection and protection systems, cultural diversity, harassment in the workplace, survey of professional career opportunities and requirements, and development of a resume.

Term(s) Offered: Fall

Symbols:

* - Discipline Studies	^ - Elective
@ - Computer Literacy	+ - Lab Science
~ - Cultural Awareness	> - C/T Elective

EMT Emergency Medical Technician

>EMT176 - Emergency Response Patient Transportation

Credits - 2 Lecture - 1 Lab - 1

Covers ambulance operations, laws, maintenance and safety, emergency response driving and route planning.

Term(s) Offered: Winter

>EMT177 - Emergency Response Communication/Documentation

Credits - 2 Lecture - 2

Covers principles of therapeutic communication, verbal, written, and electronic communications in the provision of EMS, documentation of elements of patient assessment, care and transport, communication systems, radio types, reports, codes and correct techniques.

Term(s) Offered: Fall

ENG English

*ENG104 - Introduction to Literature

Credits - 4 Lecture - 4

A course concentrating on the study of fiction through analysis of short stories and/or novels drawn from American, English, Continental, and other literature.

Prerequisite: WR115 or Placement

Recommended preparation: WR121 NOTE: Prerequisite is for spring term only; WR060 or placement winter term.

Term(s) Offered: Fall

*ENG105 - Introduction to Literature

Credits - 4 Lecture - 4

A course emphasizing the study and analysis of drama from classical times to the modern period with concentration on the principal types of drama such as comedy and tragedy.

Prerequisite: WR115 or Placement

Recommended preparation: WR121 NOTE: Prerequisite is for spring term only; WR060 or placement winter term.

Term(s) Offered: Winter, Spring

*ENG106 - Introduction to Literature

Credits - 4 Lecture - 4

A course focusing on the study of poetry, primarily lyric, drawn from American, English, Continental, and other literatures. Elements such as form, texture, and sensuous appeal are explored in close analysis of the poems.

Prerequisite: WR115 or Placement

Recommended preparation: WR121 NOTE: Prerequisite is for spring term only; WR060 or placement winter term.

Term(s) Offered: Spring

ENG English

~*ENG107 - World Literature

Credits - 4 Lecture - 4

This course focuses on great works of the ancient world in a variety of forms including: verse, drama, fiction, and non-fiction. Reading and discussion may focus on the literary traditions of the ancient Middle East, Greece, Rome, India, and China.

Prerequisite: WR115 or Placement

Recommended preparation: WR121 NOTE: Prerequisite is for spring term only; WR060 or placement winter term.

~*ENG108 - World Literature

Credits - 4 Lecture - 4

This course focuses on great works from roughly 400CE to 1600CE in a variety of forms including: verse, drama, fiction, and non-fiction. Reading and discussion may focus on the literary traditions of Western Europe, Africa and Asia.

Prerequisite: WR115 or Placement

Recommended preparation: WR121 NOTE: Prerequisite is for spring term only; WR060 or placement winter term.

Term(s) Offered: Winter

~*ENG109 - World Literature

Credits - 4 Lecture - 4

This course focuses on great works of the modern world in a variety of forms including: verse, drama, fiction, and non-fiction. Reading and discussion may focus on the literary traditions of Latin America, the Middle-East and Africa, as well as Europe.

Prerequisite: WR115 or Placement

Recommended preparation: WR121 NOTE: Prerequisite is for spring term only; WR060 or placement winter term.

Term(s) Offered: Fall

*ENG197 - Film as Literature

Credits - 4 Lecture - 4

This course explores film as an art form, fostering visual literacy through close attention to the cinema. It will concentrate on the importance of acting, drama, ideology, theory and literary adaptation to film.

Prerequisite: WR115 or Placement

Recommended preparation: WR121 NOTE: Prerequisite is for spring term only; WR060 or placement winter term.

Term(s) Offered: Winter

^ENG198 - Special Studies

Credits - 1-3

This course is designed to provide interested and capable students special topics in English.

ENG English

*ENG201 - Shakespeare

Credits - 4 Lecture - 4

A survey of the Elizabethan era and of Shakespeare's dramatic works. Students read early comedies, histories, and tragedies giving special attention to the overall design of each work as well as to its individual beauties.

Prerequisite: WR115 or Placement

Recommended preparation: WR121 NOTE: Prerequisite is for spring term only; WR060 or placement winter term.

*ENG202 - Shakespeare

Credits - 4 Lecture - 4

A survey of Shakespeare's middle period. Students read plays of various genres, but class emphasis falls on historical plays with discussion of Shakespeare's developing view of man, society and government.

Prerequisite: WR115 or Placement

Recommended preparation: WR121 NOTE: Prerequisite is for spring term only; WR060 or placement winter term.

Term(s) Offered: Winter

*ENG203 - Shakespeare

Credits - 4 Lecture - 4

A survey of Shakespeare's later plays including the great tragedies and the romances. Students study both dramatic forms and poetry and discuss the philosophic implications of these major plays.

Prerequisite: WR115 or Placement

Recommended preparation: WR121 NOTE: Prerequisite is for spring term only; WR060 or placement winter term.

*ENG204 - Survey of English Literature

Credits - 4 Lecture - 4

This course is a study of the principal works of English literature. Students concentrate on Anglo-Saxon and Medieval literature in the first term and become familiar with literary traditions through reading, lecture, discussion and film.

Prerequisite: WR115 or Placement

Recommended preparation: WR121 NOTE: Prerequisite is for spring term only; WR060 or placement winter term.

Term(s) Offered: Fall

*ENG205 - Survey of English Literature

Credits - 4 Lecture - 4

The second term of this survey focuses on Renaissance and Eighteenth-Century English literature. Students read and discuss major authors, including Shakespeare, Milton, Swift and Pope.

Prerequisite: WR115 or Placement

Recommended preparation: WR121 NOTE: Prerequisite is for spring term only; WR060 or placement winter term.

Symbols:

* - Discipline Studies ^ - Elective
 @ - Computer Literacy + - Lab Science
 ~ - Cultural Awareness > - C/T Elective

Course Descriptions

ENG

English

*ENG206 - Survey of English Literature

Credits - 4 Lecture - 4

The third term of this survey sequence focuses on Modern English Literature. The authors are representative rather than inclusive.

Prerequisite: WR115 or Placement

Recommended preparation: WR121 **NOTE:** *Prerequisite is for spring term only; WR060 or placement winter term.*

^ENG240 - Native American Literature

Credits - 3 Lecture - 3

A discussion seminar designed to introduce the student to the emergence of literature being written by members of the first nations of North America, and the connection of that contemporary literature to the oral literature of myth, story, lyric and ritual poetry and oratory.

Recommended preparation: WR121

~*ENG253 - Survey of American Literature

Credits - 4 Lecture - 4

The first of a three-part sequence, this course is a discussion seminar that surveys a multicultural representation of American literary works and major writers from pre-European contact to the Civil War. Or emphasis may be on genre, with the first term focusing on American fiction.

Prerequisite: WR115 or Placement

Recommended preparation: WR121 **NOTE:** *Prerequisite is for spring term only; WR060 or placement winter term.*

*ENG254 - Survey of American Literature

Credits - 4 Lecture - 4

The second of a three-part sequence, this course is a discussion seminar that surveys a multicultural representation of American authors and literary works from the Civil War to World War II. Or emphasis may be on genre, second term focusing on American drama.

Prerequisite: WR115 or Placement

Recommended preparation: WR121 **NOTE:** *Prerequisite is for spring term only; WR060 or placement winter term.*

*ENG255 - Survey of American Literature

Credits - 4 Lecture - 4

The last of a three-part sequence, this course is a discussion seminar that considers a multicultural representation of major American writers and literary works from World War II to the present. Or emphasis may be on genre, with the third term focusing on American poetry.

Prerequisite: WR115 or Placement

Recommended preparation: WR121 **NOTE:** *Prerequisite is for spring term only; WR060 or placement winter term.*

Symbols:

* - Discipline Studies ^ - Elective
@ - Computer Literacy + - Lab Science
~ - Cultural Awareness > - C/T Elective

ENG

English

~*ENG260 - Introduction to Women Writers

Credits - 4 Lecture - 4

An examination of writing by women. Students read a variety of fiction and nonfiction forms by women from various places and periods.

Genres may include poetry, folksongs, diary and journal entries, fiction and drama, and non-fiction.

Prerequisite: WR115 or Placement

NOTE: *Prerequisite is for spring term only; WR060 or placement winter term.*

*ENG263 - Detective Fiction

Credits - 4 Lecture - 4

Investigation of the detective genre, its historical patterns, and its evolution from Poe to popular contemporary writers. Students will read a variety of detective novels/short stories in the categories of the Armchair/Cerebral Detective and Hard Boiled Detective.

Prerequisite: WR115 or Placement

Recommended preparation: WR121 **NOTE:** *Prerequisite is for spring term only; WR060 or placement winter term.*

*ENG264 - Detective Fiction

Credits - 4 Lecture - 4

Investigation of the detective genre, its historical patterns and its evolution from Poe to popular contemporary writers. Students will read a variety of detective novels/short stories in the category of the Police Detective in America, in England and in Europe.

Prerequisite: WR115 or Placement

Recommended preparation: WR121 **NOTE:** *Prerequisite is for spring term only; WR060 or placement winter term.*

Term(s) Offered: Spring

*ENG269 - Nature Literature

Credits - 4 Lecture - 4

People often explain themselves and their world according to how they define and perceive their relationship with nature. The Nature Literature course will examine how people's literature reflects their mythological, theological, philosophical, and scientific views towards nature. Readings will include fiction, poetry, and nonfiction that project a variety of attitudes towards nature.

Prerequisite: WR115 or Placement

NOTE: *Prerequisite is for spring term only; WR060 or placement winter term.*

Term(s) Offered: Spring

^ENG280 - Cooperative Work Experience

Credits - 1-8

Provides experience in English classroom for selected English major students who are exploring English teaching.

Recommended preparation: WR121

FN

Health/Physical Education

^FN225 - Nutrition

Credits - 4 Lecture - 4

Nutrition is the study of the nutrients in food and how the body uses them through the life cycle. Food sources, functions and recommendations for the six nutrients are covered. Digestion, absorption and metabolism are discussed. Skills will be developed in evaluation of nutrition information, assessment of dietary intake, recognition of timely national nutrition issues, and an increased awareness of the relationship of diet upon chronic disease. A variety of instructional methods will be selected but emphasis will be upon collaborative learning.

Term(s) Offered: Fall, Winter, Spring

>FN230 - Children, Families and Nutrition

Credits - 3 Lecture - 3

This is a course for parents, families, child and health care providers, and early childhood educators. Basic nutrition for the pregnant and breastfeeding woman, the breastfed and bottle-fed infant, and the child will be covered. Gaining understanding of how eating habits develop and the roles of the child and the parent will be emphasized as well as positive techniques for feeding infants, toddlers and preschooler and dealing with various feeding situations. Nutrition challenges for the child with special health care needs will be included. Resources for planning and preparing nutritious meals will be shared and a toolbox of community nutrition services, menus, recipes and nutrition education activities and materials will be developed by each participant.

G

Science

+G101 - Introduction to Geology - Minerals and Rocks

Credits - 4 Lecture - 3 Lab - 1

A study of the structure and composition of the Earth; minerals; igneous, metamorphic, and sedimentary rocks; as well as the source and use of geologic resources by society.

Prerequisite: MTH025 or Placement and RD090 or Placement

Course fulfills laboratory science requirement. Need not be taken in sequence.

Term(s) Offered: Fall, Winter

+G102 - Introduction to Geology - Environmental Geology

Credits - 4 Lecture - 3 Lab - 1

This course examines plate tectonics, earthquakes and surface processes. Special consideration will be given to how these processes interact with human society.

Prerequisite: MTH025 or Placement and RD090 or Placement

Course fulfills laboratory science requirement. Need not be taken in sequence.

Term(s) Offered: Winter

G Science

+G103 - Introduction to Geology - Historical Geology

Credits - 4 Lecture - 3 Lab - 1

A study of the early history of Earth and geologic time scale. Sedimentation, sedimentary environment, fossils, and fossilization are discussed along with the stratigraphic history of North America. The beginnings of life are traced through the evolution of plants, vertebrates, and invertebrates.

Prerequisite: MTH025 or Placement and RD090 or Placement

Course fulfills laboratory science requirement. Need not be taken in sequence.

Term(s) Offered: Spring

*G145 - Geology of the Pacific Northwest

Credits - 3 Lecture - 3

A study of the regional geology of the Pacific Northwest. This course traces the geologic evolution of the Northwest and includes discussion on the history of volcanic activity, fossils, sedimentary environments, and topographic change with time. Field trips to points of interest where appropriate.

*G146 - Rocks and Minerals

Credits - 3 Lecture - 3

An introduction to origin and identification of common rocks and minerals. Topics include crystal forms, physical tests, chemical tests, gem materials, etc. Designed for a rock hound, casual collector, or anyone interested in knowing more about rocks and minerals. Field trips where appropriate.

*G147 - Basic Geology

Credits - 3 Lecture - 3

An introduction to physical geology, designed to help one become more aware of the processes that shape our geological environment. Topics include rock and mineral formation and identification, volcanoes, earthquakes, plate tectonics, glaciations. Field trips where appropriate.

^G198 - Special Studies

Credits - 1-3

This course is designed to provide interested and capable students special topics in geology.

G Science

+G201 - Physical Geology

Credits - 4 Lecture - 3 Lab - 1

An in-depth study of the geologic processes occurring on Earth. There are no prerequisites, although a background in science is helpful. Satisfies laboratory science requirements for both science and non-science majors. Topics studied include the origin and identification of rocks and minerals, volcanoes, earthquakes, and plate tectonics. Generally one weekend field trip.

Prerequisite: MTH070 or Placement and WR115 or Placement

Need not be taken in sequence.

Term(s) Offered: Fall

+G202 - Physical Geology

Credits - 4 Lecture - 3 Lab - 1

Topics studied will include evolution of landscapes, stream erosion, glaciations, landslides, and interpretation of topographic maps and aerial photos. There are no prerequisites, although a background in science is helpful. Satisfies laboratory science requirements for both science and non-science majors. Generally one weekend field trip.

Prerequisite: MTH070 or Placement and WR115 or Placement

Need not be taken in sequence.

Term(s) Offered: Winter

+G203 - Historical Geology

Credits - 4 Lecture - 3 Lab - 1

An examination of the evolution of Earth from the standpoint of plate tectonics, including life forms, rock correlation and geologic time. There are no prerequisites, although a background in science is helpful. Satisfies laboratory science requirement for both science and non-science majors. Generally one weekend field trip.

Need not be taken in sequence.

GEOG Science

*GEOG101 - Physical Geography

Credits - 4 Lecture - 4

Introduction to physical geography of the earth with specific emphasis on landforms, climate, vegetation, and soils and on the interaction between humans and these elements.

Prerequisite: WR115 or Placement

Term(s) Offered: Fall, Winter, Spring

GEOG Science

~*GEOG103 - Human Geography

Credits - 4 Lecture - 4

This course introduces students to the discipline of geography and studies patterns of a wide variety of topics including industry and economy, population, language, religion, ethnicity, urban patterns, politics, and the effects of globalization on these patterns.

Prerequisite: WR115 or Placement

NOTE: Prerequisite is for spring term only; WR060 or placement winter term.

Term(s) Offered: Fall

~*GEOG120 - World/Regional Geography

Credits - 4 Lecture - 4

This course studies world patterns of the natural and cultural environments and focuses on the place of each geographic region in the world community.

Prerequisite: WR115 or Placement

NOTE: Prerequisite is for spring term only; WR060 or placement winter term.

Term(s) Offered: Fall, Winter

*GEOG206 - Geography of Oregon

Credits - 4 Lecture - 4

A study of the diverse landscapes of Oregon. This course considers natural environment, population growth, and settlements. Special emphasis is placed on the historical geography of selected areas of the state.

Prerequisite: WR115 or Placement

Recommended preparation: COM111. NOTE: Prerequisite is for spring term only; WR060 or placement winter term.

Term(s) Offered: Spring

^GEOG298 - Special Studies

Credits - 1-3

Designed to provide interested and capable students with the opportunity to study special topics in geography.

Recommended preparation: WR060

GS Science

+GS104 - Physical Science/Physics

Credits - 4 Lecture - 3 Lab - 1

A one-term introduction to the fundamental physical concepts that form the foundation for all of the physical sciences. Topics include measurement, motion, mechanics, and pressure.

Prerequisite: MTH070 or Placement

Term(s) Offered: Fall

Symbols:

* - Discipline Studies	^ - Elective
@ - Computer Literacy	+ - Lab Science
~ - Cultural Awareness	> - C/T Elective

Course Descriptions

GS Science

+GS105 - Physical Science/Chemical Concepts

Credits - 4 Lecture - 3 Lab - 1

A one-term introduction to chemistry and its application to everyday phenomena. Topics include structure of the atom, chemical bonding, solutions, acids and bases, and chemical reactions.

Prerequisite: MTH070 or Placement

Term(s) Offered: Winter

+GS107 - Physical Science/Astronomy

Credits - 4 Lecture - 3 Lab - 1

A one-term introduction to astronomy that surveys the history of astronomy, our solar system, galaxy, and universe. Topics of current interest to astronomers will be presented. Course includes outdoor observations.

Prerequisite: MTH070 or Placement

+GS110 - Physical Science/Energy

Credits - 4 Lecture - 3 Lab - 1

Overview of the sources of energy in nature. Emphasis on how energy is coupled to specific principles and processes related to physics and chemistry. Topics include heat, radioactivity, light, sound, and electricity.

Prerequisite: MTH070 or Placement

Term(s) Offered: Winter, Spring

+GS111 - Physical Science/Forensic Science

Credits - 4 Lecture - 3 Lab - 1

A one-term introduction to criminalistic theories and practices, including basic techniques of investigation. Topics include fingerprints, blood typing, photography and casting techniques. Course fulfills a laboratory science requirement.

Prerequisite: MTH025 or Placement and RD090 or Placement

Term(s) Offered: Winter

+GS142 - Physical Geology/Earth Revealed

Credits - 4 Lecture - 3 Lab - 1

This online course examines the evolution of planet Earth based upon the dynamics of interacting systems and physical geological attributes of the planet including geologic time, physical phenomena, and weathering. A "field exercise" will be included that will integrate physical geology concepts with a "real world" experience that will be conducted in the community of each individual student.

Prerequisite: MTH025 or Placement and RD090 or Placement

Term(s) Offered: Fall, Winter, Spring

GS Science

^GS160 - Observational Astronomy

Credits - 3 Lecture - 3

A one-term non-laboratory introduction to astronomy with emphasis on observing the night sky and fundamental astronomical concepts. Course includes outdoor

^GS198 - Special Studies

Credits - 1-3

This seminar course is offered on the basis of demand and covers diverse topics in the natural and physical sciences.

GT Engineering Tech/Civil-Drafting

>GT101 - Introduction to Industrial Sustainability

Credits - 3 Lecture - 3

Students explore a broad overview of sustainability and environmental engineering. Students learn the principles, concepts, and technology of alternative resources including power production by wave energy, wind energy, solar energy, hydrogen-fuel devices and other emerging alternative power generation systems. Students learn the basics of sustainability in an industrial context, including energy conservation, waste reduction and preventive maintenance.

>GT102 - Green Industrial Safety

Credits - 2 Lecture - 2

Students learn the essential skills needed to develop and maintain safe work habits in various industrial workplaces following OR-OSHA guidelines, including general accident prevention. Students demonstrate safe use of tools/equipment commonly found in a variety of manufacturing and construction industries. Emphasis will be put on safety procedures leading to sustainable practices and results.

>GT103 - Mechanical Systems

Credits - 3 Lecture - 2 Lab - 1

This course focuses on learning the fundamentals of mechanical power. Students learn common mechanical components from nuts and bolts to gears, gear boxes, shafts and bearings. Students perform common mechanical tasks, and learn to fine tune drive systems involving belts, chains, etc. This course demonstrates the importance of lubrication in maintaining gears and other movable parts, and emphasizes operations to reduce friction and wasted motion, which are major contributors to energy inefficiency.

GT Engineering Tech/Civil-Drafting

>GT104 - Electrical Systems Troubleshooting I

Credits - 3 Lecture - 2 Lab - 1

This course covers information on basic DC and AC electrical theory, definitions, basic component identification and analysis of series, parallel and combination circuits. Emphasis is placed on practical application, troubleshooting and problem solving. Students learn to troubleshoot common electrical problems in industry, such as low voltage, high voltage, open circuits, high resistance shorts to ground and current/voltage unbalance. Emphasis is on prevention of electrical energy waste.

>GT105 - Workplace Math/Applied Math

Credits - 4 Lecture - 4

This is an introductory algebra and geometry class in technical/ professional mathematics. Topics that are covered include measurement and conversions, signed numbers, algebraic equations and formulas, ratio and proportion, perimeters, areas, volumes, reading and interpreting graphs, and measures of central tendency.

>GT106 - Introduction to Green Technologies

Credits - 2 Lecture - 2

Students will be introduced to economic and environmental considerations for selecting appropriate green technologies and techniques to compare technology options. Technologies in the areas of energy production, transportation, electrical systems, building systems, and agriculture will be examined. Emphasis will be on identifying and selecting appropriate and cost-effective tools and technology solutions across multiple industries and sustainable decision making.

>GT107 - Electrical Systems Troubleshooting II

Credits - 3 Lecture - 2 Lab - 1

This course covers the theory and application of magnetism, electromagnetism, the generation of electromotive force, AC and DC motor principles, transformer theory, types and applications. Students are introduced to electrical control circuits and the operation of a transistor. Students build on basic techniques and learn systematic troubleshooting methods and procedures to solve process problems. Analyzing motor control schematics and using advanced digital multi meters are stressed. Emphasis is on prevention and correction of energy wasting problems.

Symbols:

* - Discipline Studies	^ - Elective
@ - Computer Literacy	+ - Lab Science
~ - Cultural Awareness	> - C/T Elective

GT Engineering Tech/Civil-Drafting

>GT108 - Building Systems

Credits - 2 Lecture - 1 Other - 1

Students learn basic principles of building science to assess building energy efficiency and monitor health and safety conditions, with an emphasis on a system analysis approach to inspection. Inter-connected system analysis includes the building's envelope, foundation, walls roof, doors and windows. Students learn how to use diagnostic equipment to analyze the effectiveness of the building systems to maximize energy performance, comfort, efficiency, safety and durability. Students will learn about using the HVAC ducting and digital controls (DDC) system as an aid in troubleshooting and promoting energy efficiency, and indoor air quality.

>GT109 - HVACR Systems Operations

Credits - 3 Lecture - 2 Lab - 1

Students will learn the concepts of the basic operations of various heating and cooling systems for commercial and residential applications. This course focuses on maintenance and service procedure for initial tuning of HVACR systems for energy efficiency. Practical application of skills include: taking pressures, identifying refrigerants, recovering and recycling refrigerant, evacuating and charging refrigeration systems. Also included are all applicable safety precautions and EPA governed environmental regulations. Energy efficiency will be emphasized.

>GT110 - Workplace Communications

Credits - 3 Lecture - 3

Students will practice small group communication by participation in group discussions, readings, and written exercises. Attention to organization and conduct of problem-solving groups and learning. Emphasis is on, (1) learning how to enhance group communication, to deal effectively with conflict and to apply problem-solving techniques and (2) developing attitudes and skills applicable to leadership and successful participation in the workplace.

>GT111 - Preventive Maintenance/Energy Conservation

Credits - 2 Lecture - 2

Examines the development and implementation of a preventative maintenance program using proven actions and procedures and common computer software. Students will learn how to design, construct, and maintain industrial transfer systems. The emphasis of this course is the application of preventive maintenance strategies to green technology and efficiency.

GT Engineering Tech/Civil-Drafting

>GT112 - Control systems

Credits - 3 Lecture - 2 Lab - 1

Students will learn fundamentals of programmable logic control (PLC) operation, and troubleshooting. Variable speed drive operation and programming is covered as are process control principles for temperature and flow. Emphasis is on understanding of control operations for efficiency. This course will utilize on-line training and a hands-on seminar to offer hands-on learning opportunities.

>GT113 - Fluid Power

Credits - 3 Lecture - 2 Other - 1

This course provides an introduction to hydraulic schematics, troubleshooting common hydraulic problems and maintaining hydraulic systems used in a variety of production applications. It also provides an introduction to operating a pneumatic system, including maintenance and troubleshooting procedures. Students learn to read, interpret, and construct fluid systems schematic diagrams containing pneumatic and hydraulic component systems. Emphasis will be on operation of fluid power systems for energy savings and pollution controls.

>GT114 - Local Applications/Alternative Energy

Credits - 3 Lecture - 3

This course is an introduction to the basic concepts and terminology of alternative energy sources. Subjects that will be explored in this course are biodiesel, wind, solar cells, fuel cells, ocean wave, geothermal, hydrogen, connection to the grid (homeowners), electric vehicles, as well as other emerging types of energy production. Research into old technologies as well as new will be explored, and students will research the applications of alternative energy in their local/regional communities and economies, including opportunities for employment.

>GT115 - Human Relations/Customer Service

Credits - 3 Lecture - 3

This course is designed to enable students look at many factors that influence human behavior. The intent of this course is to help students increase their ability to handle interpersonal conflicts effectively at work and in your personal lives.

HD College Prep

HD College Prep

HD080 - Life Transitions

Credits - 2 Other - 2

This course is a five-week series of seminars designed for students to develop self-knowledge, coping skills, confidence-building, communication skills, parenting skills, and how to have healthy relationships. Included in this course will be exploration of specific careers and orientation to job-search techniques, learning about college support services, managing resources, networking, exploring nontraditional training options, setting goals, and developing action plans.

^HD100 - College Survival and Success

Credits - 3 Lecture - 3

This course teaches students approaches and techniques that will support their success both as individuals and as students in college. Focus is on academic strategies which include note taking, test taking and text reading. Coping skills such as time management, stress management, assertiveness, and methods for organization will also be presented.

Term(s) Offered: Fall, Winter, Spring

^HD109 - Academic Planning

Credits - 1 Lecture - 1

This course covers pathways to gaining a particular certificate or degree from BMCC. Included will be tools to help students determine their learning style and personality type. Students will take career assessments, write goals, and create an academic plan that will facilitate their progress toward the goals. Hindrances to academic progress will also be addressed.

Term(s) Offered: Fall, Winter, Spring

^HD110 - Career Planning

Credits - 2 Lecture - 2

Students gain information about themselves and occupations. They choose two careers and support their choices based upon the information they have acquired. They use interest inventories, computerized exploration programs, and an entrepreneur quiz. They will use the Career Information System to find sources of training and financial aid for the careers they have chosen.

^HD151 - Service Leadership

Credits - 1 Lecture - 1

Designed to provide training in leadership skills for elected student government officers and representatives. Not open to general student enrollment. Course serves as a bridge between community/civic/legislative service and academic experience. Focus is on communication skills, small group dynamics, presentation skills and leadership styles.

Repeatable for maximum of 3 credits.

Term(s) Offered: Fall

Symbols:

* - Discipline Studies ^ - Elective
 @ - Computer Literacy + - Lab Science
 ~ - Cultural Awareness > - C/T Elective

Course Descriptions

HD

College Prep

^HD152 - Service Leadership

Credits - 1 Lecture - 1

Designed to provide training in leadership skills for elected student government officers and representatives. Not open to general student enrollment. Course serves as a bridge between community/civic/legislative service and academic experience. Focus is on communication skills, small group dynamics, presentation skills, and leadership styles.

Repeatable for maximum of 3 credits.

Term(s) Offered: Winter

^HD153 - Service Leadership

Credits - 1 Lecture - 1

Designed to provide training in leadership skills for elected student government officers and representatives. Not open to general student enrollment. Course serves as a bridge between community/civic/legislative service and academic experience. Focus is on communication skills, small group dynamics, presentation skills and leadership styles.

Repeatable for maximum of 3 credits.

Term(s) Offered: Spring

^HD154 - Ambassadorship

Credits - 1 Lecture - 1

The Student Ambassadors' primary function is to provide leadership, assistance, and information to prospective BMCC students and to assist the College in attracting prospective students. Ambassadors will be responsible for conducting tours, participating in Ambassador training events, visiting high schools, provide office assistance, and other assigned duties. This course covers public speaking, leadership, etiquette, marketing, and college knowledge.

Repeatable for maximum of 3 credits.

Term(s) Offered: Fall

^HD204 - Self-Motivation and Personal Potential

Credits - 3 Lecture - 3

Students will learn and explore methods for eliminating recurring behavior, feelings or thoughts which can negatively affect the quality of their lives. Subject matter covered will be the psychology of wellness, principles of behavior modification and a holistic approach to an individual's ability to develop a successful self-management plan for living. Focus will be on kinds of life planning, positive health management, assertive communication, social fulfillment and emotional well-being. This course goes beyond acquisition of knowledge or personal awareness. It also includes experiential and collaborative learning in addition to more traditional approaches.

HD

College Prep

^HD206 - Coping Skills for Stress

Credits - 3 Lecture - 3

The theories and practices of stress management will be presented in this course. Techniques for coping, such as relaxation, visualization, imagery, meditation, exercise, nutrition, rational-emotive thinking, assertion and time management will be employed. Students will be required to assess the impact of various stressors upon their well-being and to design coping styles that are preventative and which promote their mental and physical well-being. The focus of this class is educational, not therapeutic. Emphasis will be equally divided among academic and participatory requirements.

^HD254 - Ambassadorship

Credits - 1 Lab - 1

The Student Ambassadors' primary function is to provide leadership, assistance, and information to prospective BMCC students and to assist the College in attracting prospective students. Ambassadors will be responsible for conducting tours, participating in Ambassador training events, visiting high schools, provide office assistance, and other assigned duties. This course expands on the public speaking, leadership, etiquette, marketing, and college knowledge learned in the first year, and includes mentorship of first year students.

Repeatable for maximum of 3 credits.

Term(s) Offered: Fall, Winter, Spring

HE

Health/Physical Education

>HE100 - Introduction to Health Services

Credits - 3 Lecture - 3

Individually designed shadow experiences within the health service professional field that provide the learner the opportunity to apply skills as well as obtain knowledge of various health career occupations. Basic First Aid and CPR are included.

*HE115 - Body Composition Assessment

Credits - 1 Lecture - 1

Percent Body Fat (or lean-to-fat ratio) is a better indicator of health and fitness than scale weight is. This class teaches students about the different methods of assessing percent body fat, their advantages and disadvantages, and how reliable they are. Students will learn to assess lean-to-fat ratio using the skin fold assessment method.

Term(s) Offered: Fall, Winter, Spring

HE

Health/Physical Education

*HE250 - Personal Health

Credits - 3 Lecture - 3

A visionary look at the state of health and health care today. This distance education course offers teachers and learners an up-to-the-minute look at health and health care issues from weight management to cardiovascular disease and from the latest HIV/AIDS treatment to changes in health care delivery systems. Personal Health combines interviews with leading health professionals, dynamic location footage, and illustrative case studies to bring each lesson to life.

Term(s) Offered: Fall, Winter, Spring

*HE252 - First Aid

Credits - 3 Lecture - 3

This course is designed to provide the student with the knowledge and skills necessary in an emergency to call for help, to help keep someone alive, to reduce pain, and to minimize the consequences of injury or sudden illness until professional medical help arrives. Successful completion will lead to an American Red Cross community first aid and community CPR certification.

Term(s) Offered: Fall, Winter, Spring

*HE253 - Personal Nutrition

Credits - 3 Lecture - 3

Orientation to the importance of a diet that is low in saturated fat and cholesterol while high in complex carbohydrates and fiber. Emphasis will be on helping participants choose healthy, low fat foods while still enjoying their diets. The course will include an introduction to nutrients and their uses and food sources, as well as discussion of current topics including weight management, eating disorders, exercise, fad foods and diets, recipe modifications, and reducing risk of disease related to high-fat diet.

>HE298 - Special Studies

Credits - 1-3

This course is designed to provide interested and capable students special topics in health.

HORT

Agriculture

>HORT100 - Plant Science

Credits - 3 Lecture - 3

Basic principles of plant science and the environmental factors associated with plant growth and development constitute the core of this course. Agricultural application of plants will be emphasized.

Corequisite: AGR280

Term(s) Offered: Fall

Symbols:

* - Discipline Studies ^ - Elective
 @ - Computer Literacy + - Lab Science
 ~ - Cultural Awareness > - C/T Elective

Course Descriptions

HORT

Agriculture

>HORT111 - Alternative Crop Production

Credits - 3 Lecture - 3

Explores specialty crop production such as seed, berry, fruit, and melon production. Mulch use and drip irrigation will be emphasized. Greenhouse work may also be included.

Corequisite: AGR280

Term(s) Offered: Spring

HPE

Health/Physical Education

*HPE295 - Health and Fitness for Life

Credits - 3 Lecture - 3

Develop an understanding of the interacting influences of physical fitness, nutrition, stress management, and health. Course covers many wellness topics including weight control, eating disorders, diet analysis, methods for behavior change, avoiding destructive habits, cardiovascular health, and maintaining a healthy back.

Term(s) Offered: Fall, Winter, Spring

HST

Social Science

^HST104 - World Civilizations I

Credits - 3 Lecture - 3

The first in a series of three World Civilizations courses, the course begins with a study of Near Eastern, Greco-Roman, Indian, and Chinese civilizations; and their basic institutions and divergent tendencies.

Recommended preparation: WR060

^HST105 - World Civilizations

Credits - 3 Lecture - 3

The second in a series of three World Civilizations courses, this course focuses on the impact on other world civilizations of the West's rise to world dominance between 700 and 1700 A.D.

Recommended preparation: WR060

~*HST201 - History of the United States

Credits - 4 Lecture - 4

History 201 provides a broad overview of the historical events that helped create the United States, as well as their causes. The goal is to acquaint students with major events of the region, their chronology and to stimulate creative and critical thought about the history of US.

Prerequisite: WR115 or Placement

NOTE: Prerequisite is for spring term only; WR060 or placement winter term.

Term(s) Offered: Fall, Winter

HST

Social Science

~*HST202 - History of the United States

Credits - 4 Lecture - 4

This course begins with expansion and slavery, covers the Civil War and Reconstruction and concludes with the rise of the industrial state and the Progressive Era. The course will cover the period from c. 1815 to 1917.

Prerequisite: WR115 or Placement

NOTE: Prerequisite is for spring term only; WR060 or placement winter term.

Term(s) Offered: Winter, Spring

~*HST203 - History of the United States

Credits - 4 Lecture - 4

This course begins with the Progressive Era and covers development through the Twentieth Century to the present.

Prerequisite: WR115 or Placement

NOTE: Prerequisite is for spring term only; WR060 or placement winter term.

Term(s) Offered: Winter, Spring

^HST298 - Special Studies

Credits - 1-3

Specialized courses which may be offered periodically depending on demand and availability.

Recommended preparation: WR060

HTM

Business Technologies

>HTM100 - Hospitality and Tourism Industry

Credits - 3 Lecture - 3

Introduces the hospitality industry as a single, interrelated industry composed of food and beverage, travel and tourism, lodging, meeting and planning events, recreation and leisure, recreational entertainment, and eco and heritage tourism.

Prerequisite: WR060

Term(s) Offered: Fall

>HTM103 - Marketing in the Hospitality Industry

Credits - 3 Lecture - 3

This course studies how marketing activities direct the flow of goods and services from product to consumer in the hospitality and tourism industry.

Prerequisite: WR060

HTM

Business Technologies

>HTM104 - Travel and Tourism Industry

Credits - 3 Lecture - 3

This course explores the major concepts in tourism; what makes tourism possible; and how tourism can become an important factor in the economics of any nation, region, state, or local area. Discusses the fundamentals of the tourism system and the key costs and benefits of a tourism economy. Promotes understanding and knowledge of the diverse elements that constitute the travel and tourism industry and the factors that influence growth and development. Examples of tourism development practices in Oregon will be addressed.

>HTM105 - Food and Beverage Industry

Credits - 3 Lecture - 3

This course covers the food service industry including its structure, organization, size, economic impact, regulatory industries, and peripheral industries; managerial problems and practices; and trade journals and resources. Reviews food service segments. Discusses current industry operational topics.

Prerequisite: WR060 and either BA104 or MTH025

Term(s) Offered: Winter

>HTM107 - Hospitality Cost Control

Credits - 3 Lecture - 3

This course covers principles and practices of sanitation and safety for managers. Students will discuss Hazard Analysis Critical Control Point (HACCP) system. Covers potable water systems, waste treatment, lodging facilities, recreational facilities, swimming pool and spa regulations, and hazardous materials.

Prerequisite: WR060 and either BA104 or MTH025

Term(s) Offered: Spring

>HTM109 - Introduction to the Lodging Industry

Credits - 3 Lecture - 3

This course introduces the lodging industry, including its structure, size, scope, managerial problems, and practices. Covers the structure and organization within the individual firm's front-office procedures. This course will also explore career opportunities.

Prerequisite: WR060

Term(s) Offered: Winter

>HTM112 - Bed and Breakfast Management

Credits - 3 Lecture - 3

This is an overview course designed to explore the subject of the bed and breakfast and inn keeping industry. Course discusses the realities of purchasing, owning, and operating a successful inn. Topics will explore design, financing, operations, food service/sanitation, marketing, and governmental regulations.

Symbols:

* - Discipline Studies ^ - Elective
 @ - Computer Literacy + - Lab Science
 ~ - Cultural Awareness > - C/T Elective

Course Descriptions

HTM Business Technologies

>HTM127 - Selling in the Hospitality Industry

Credits - 3 Lecture - 3

This course prepares travel and tourism students for a successful career in selling travel. It creates an understanding of the broader sales environment. Applies concepts and techniques to sample sales dialogues, examples, and case studies. Assesses the impact of the Internet and e-commerce trends on the travel industry, how consumers currently use the Internet to make travel purchases, and the functionality of travel e-commerce sites. Focuses on how e-commerce travel sites integrate with global distribution systems and the changing value chain in the travel marketplace.

Prerequisite: WR060 and either BA104 or MTH025

Term(s) Offered: Spring

>HTM130 - Beverages

Credits - 3 Lecture - 3

This course focuses on cost control, inventory management, and pricing systems required for restaurant and food service operations. It discusses customer demographics shifts, and beverage trends and the importance of responsible alcohol beverage service. It covers wine and beer appreciation, including regional differences, production methods, and upscale product features of distillates. It incorporates beverage mixology, marketing, and profit management.

Prerequisite: WR060 and either BA104 or MTH025

Term(s) Offered: Spring

>HTM131 - Customer Service Management I

Credits - 3 Lecture - 3

This course provides an in-depth study of the methods and techniques employed by the hospitality and tourism industry to accomplish effective and efficient customer service operation. Includes combined discussions of management theory, systems, decision-making, and leadership directly relevant to any profession with emphasis on the hospitality industry. Also covers the business facets of human resource management, finance, ethics, and total quality management with a business environment.

Prerequisite: WR060

Term(s) Offered: Fall, Winter

HTM Business Technologies

>HTM224 - Catering Operations

Credits - 3 Lecture - 3

This course will study on-premise catering facilities, including operations, sales, and relationships with outside vendors and related departments and industries. Emphasizes logistical operations and seeking and servicing various market segments.

Prerequisite: Either WR060 or WR065 and MTH025 and HTM105

Term(s) Offered: Fall

>HTM226 - Event Management

Credits - 3 Lecture - 3

Focuses on the management and operations of the meeting, convention, and event market of the hospitality and tourism industry. Introduces the meetings industry, promotional activities, and negotiations for meeting services. Covers convention market salesmanship, customer service, and convention servicing. Incorporates facilities, technology, and media components.

Prerequisite: Either BA104 or MTH025 and WR060 or WR065

Term(s) Offered: Fall, Winter

>HTM230 - Hotel, Restaurant and Travel Law

Credits - 3 Lecture - 3

A comprehensive course of study designed to inform and educate students with the legal aspects of the hospitality and tourism industry. Utilizes critical thinking skills to teach students to communicate with their attorneys, to recognize the ramifications of the policies and practices of their businesses, and to apply practical principles to everyday operations. Students will discuss the recent legal situations and the reasoning of the course taken. Discussions will also be held on the Disabilities Act, sexual discrimination, and civil rights issues. Other discussions include basic court procedures, contract law negligence, guest relationship obligations, alcohol liability, travel agent relationships, licensing, and regulations.

Prerequisite: WR060

Term(s) Offered: Spring

>HTM232 - Menu Design

Credits - 3 Lecture - 3

This course covers principles of planning a menu, from concept development and design mechanics to menu pricing and marketing issues. Addresses current food service industry needs, including operations, sanitation, and nutrition concerns; design mechanics; and increasing sales through the menu.

Prerequisite: WR060

Term(s) Offered: Fall

LA College Prep

LA College Prep

LA025 - Language Arts

Credits - 4 Lecture - 4

This course covers basic reading, writing, spelling, and vocabulary skills needed to prepare students for higher level language arts courses. Reading skills will focus on increasing critical thinking and analysis skills as well as increasing vocabulary fluency and recognition. Writing skills will focus on improving grammar, spelling, punctuation, sentence structure, and paragraph and essay development and organization.

Term(s) Offered: Fall, Winter, Spring

LA035 - Language Arts

Credits - 4 Lecture - 4

This course covers skills needed in reading, writing, and vocabulary to be successful in higher level college courses such as Writing 60 and Writing 121. Reading skills will focus on critical thinking, effective analysis, and the understanding and use of advanced vocabulary. Writing skills will focus on developing paragraphs and essays with emphasis on appropriate grammatical use, essay structure, styles of writing, and conducting research.

Prerequisite: LA025 or WR025

Term(s) Offered: Fall, Winter, Spring

MS College Prep

^MS101 - Introduction to Leadership and Personal Development

Credits - 2 Lecture - 2

MS101 introduces students to the personal challenges and competencies that are critical for effective leadership. They will learn how the personal development of life skills such as goal setting, time management, physical fitness, and stress management relate to leadership.

MTH Math/Computer Science

MTH025 - Pre-Algebra

Credits - 4 Lecture - 4

This course is designed for students who are almost ready for elementary algebra. Those who place in this course study all processes of fractions, decimals, ratio/proportion/percent, measurement, integers, basic geometry and algebraic expressions and equations.

Term(s) Offered: Fall, Winter, Spring

MTH042 - Technical Mathematics

Credits - 4 Lecture - 3 Other - 1

The student will study and demonstrate knowledge of ratios, proportions, percentages, and application of Elementary Algebra, Elementary Geometry, Elementary Trigonometry, and mathematical formulas to technical problems.

Prerequisite: MTH025 or Placement

Term(s) Offered: Winter

Symbols:

* - Discipline Studies ^ - Elective
@ - Computer Literacy + - Lab Science
~ - Cultural Awareness > - C/T Elective

MTH Math/Computer Science

MTH070 - Elementary Algebra

Credits - 5 Lecture - 5

The student will demonstrate knowledge of basic algebra notation, linear equations and inequalities, graphing, linear systems, exponents, and polynomials.

Prerequisite: MTH025 or Placement

Term(s) Offered: Fall, Winter, Spring

>MTH084 - Technical Mathematics for Civil Engineer Technicians

Credits - 2 Lecture - 2 Lab - Other -

This course will prepare students for further classes in technical programs. Emphasis will be on planar geometry, solid geometry, and right angle trigonometry as it applies to land surveying, civil engineering technical courses, and other trades.

Prerequisite: MTH025 or Placement

Term(s) Offered: Winter

MTH095 - Intermediate Algebra

Credits - 5 Lecture - 5

The student will study and demonstrate knowledge of skills to include solving algebraic equalities and inequalities, and systems of linear and nonlinear equations. Also included are graphing algebraic functions. Emphasis is placed on algebraic problem-solving skills; a graphing calculator will be used as a tool to further algebraic knowledge.

Prerequisite: MTH070 or Placement

Term(s) Offered: Fall, Winter, Spring

^MTH103 - Problem Solving with Technology

Credits - 1 Lab - 1

A mathematics problem solving course that applies prerequisite algebra skills. Students practice critical thinking skills in a variety of algebraic areas. The main focus of this course is exploration of algebra through the use of technology, i.e., graphics calculators and/or computer software.

Prerequisite: MTH095 or instructor approval

*MTH105 - Introduction to Contemporary Mathematics

Credits - 4 Lecture - 4

This is a mathematics problem-solving course that applies prerequisite algebra skills. Students practice critical thinking skills in a variety of application areas chosen from the physical and social sciences, modeling, consumer math, statistics, geometry, number theory, logic, probability, and recreational math. The course stresses clear communication, problem-solving strategies, group problem-solving experiences, and appropriate use of graphics calculator and computer software as problem-solving tools.

Prerequisite: MTH095 or Placement

Symbols:

* - Discipline Studies ^ - Elective
 @ - Computer Literacy + - Lab Science
 ~ - Cultural Awareness > - C/T Elective

MTH Math/Computer Science

*MTH111 - College Algebra

Credits - 5 Lecture - 5

Students will demonstrate knowledge of functions in general, polynomial, rational, exponential, and logarithmic functions in particular. Students will also demonstrate knowledge of linear systems, sequences, and series; mathematical induction; and binomial expansion. Emphasis is placed on algebraic problem-solving skills; a graphing calculator will be used as a tool to further algebraic knowledge.

Prerequisite: MTH095 or Placement

This course will be offered as a 4 credit course Summer term 2010 only.

Term(s) Offered: Fall, Winter, Spring

*MTH112 - Elementary Functions

Credits - 5 Lecture - 5

The students will study and demonstrate knowledge of trigonometric functions, applications of trigonometry, trigonometric identities and equations, complex trigonometric numbers, linear programming, partial fractions, probability and data analysis, conic sections, parametric equations, polar coordinates, and vectors.

Prerequisite: MTH111 or Placement

Term(s) Offered: Fall

^MTH198 - Special Studies

Credits - 1-3

This course is designed to provide interested and capable students special topics in mathematics.

*MTH211 - Foundations of Elementary Mathematics

Credits - 4 Lecture - 4

The student will study and demonstrate knowledge of problem-solving, sets, relations, whole numbers, numeration systems, and number theory.

Prerequisite: MTH095 or Placement

Term(s) Offered: Fall

*MTH212 - Foundations of Elementary Mathematics

Credits - 4 Lecture - 4

The student will study and demonstrate knowledge of integers, rational numbers, real numbers, and mathematical systems.

Prerequisite: MTH211

Term(s) Offered: Winter

*MTH213 - Foundations of Elementary Mathematics

Credits - 4 Lecture - 4

The student will study and demonstrate knowledge of geometry, probability, and statistics and other topics in elementary mathematics.

Prerequisite: MTH212

Term(s) Offered: Spring

MTH Math/Computer Science

*MTH231 - Discrete Mathematics

Credits - 4 Lecture - 4

Students will study and demonstrate knowledge of topics chosen from logic, set theory, functions, algorithms, number theory, matrices, proof techniques, recursion, counting techniques, relations, and graphing theory.

Prerequisite: MTH111 or Placement

*MTH241 - Calculus for Management/Social Science

Credits - 4 Lecture - 4

Students will study and demonstrate knowledge of the basic concepts of differential and integral calculus with emphasis on the basic techniques and applications. The approach will be from an intuitive point of view.

Prerequisite: MTH111 or Placement

*MTH243 - Introduction to Probability and Statistics

Credits - 4 Lecture - 4

Students will demonstrate knowledge of graphical and numerical descriptive statistics, probability theory, probability distributions, statistical inference, and regression. The emphasis will be on statistical inference making and on interpretation of results of statistical tests. A graphing calculator will be used as an aid to data description and statistical inference.

Prerequisite: MTH111 or Placement

Term(s) Offered: Spring

*MTH251 - Calculus

Credits - 4 Lecture - 4

Students will study and demonstrate knowledge of limits, continuity, the derivative, and applications, including trigonometry.

Prerequisite: MTH112 or Placement

Term(s) Offered: Fall, Winter, Spring

*MTH252 - Calculus

Credits - 4 Lecture - 4

The student will study and demonstrate knowledge and application of the definite integral, differentiation and integration of logarithmic, exponential, trigonometric, and inverse functions and applications.

Prerequisite: MTH251 or Placement

Term(s) Offered: Winter, Spring

*MTH253 - Calculus

Credits - 4 Lecture - 4

The student will study and demonstrate knowledge of integers, rational numbers, real numbers, and mathematical systems.

Prerequisite: MTH252 or Placement

Term(s) Offered: Spring

Course Descriptions

MTH Math/Computer Science

*MTH254 - Vector Calculus

Credits - 4 Lecture - 4

The student will study and demonstrate knowledge of vector-valued functions, functions of several variables, partial differentiation and related applications, and multiple integration with related applications.

Prerequisite: MTH252

*MTH256 - Differential Equations

Credits - 4 Lecture - 4

This course covers the methods of solving ordinary differential equations and includes three types of solutions: elementary methods, convergent power series, and numerical methods, with applications to physical and engineering science.

Prerequisite: MTH252

*MTH261 - Linear Algebra

Credits - 4 Lecture - 4

Students will study and demonstrate knowledge of matrix solutions to systems of linear equations, determinants, vector spaces, GramSchmidt orthogonalizations, linear transformations, Eigen values and Eigen vectors.

Prerequisite: MTH252 or Placement

^MTH280 - Cooperative Work Experience

Credits - 1-8

Provides a supervised work experience in mathematics which supplements the "school experience" that is not possible in a normal academic classroom environment.

^MTH298 - Special Studies

Credits - 1-3

This course is designed to provide interested and capable students special topics in mathematics. It will provide statistics students an opportunity to use the statistical tools learned in the classroom to analyze real data.

Corequisite: MTH243

MUP Music

^MUP105 - Jazz Ensemble

Credits - 1 Lab - 1

Provides an opportunity for students to rehearse and perform current jazz and jazz standard literature.

Course is repeatable up to 3 times (3 credits total).

^MUP115 - General Ensemble

Credits - 1 Lab - 1

Provides an opportunity for students to rehearse and perform in a select small ensemble.

Course is repeatable up to 3 times (3 credits total).

Symbols:

* - Discipline Studies	^ - Elective
@ - Computer Literacy	+ - Lab Science
~ - Cultural Awareness	> - C/T Elective

MUP Music

^MUP122 - Concert Choir

Credits - 1 Lab - 1

Provides the skilled vocalist an opportunity to participate in a select group.

Instructor approval required. Course is repeatable up to 3 times (3 credits total).

^MUP125 - Vocal Jazz Ensemble

Credits - 1 Lab - 1

An opportunity for advanced vocalists to perform literature of the popular and/or vocal jazz styles.

Instructor approval required. Course is repeatable up to 3 times (3 credits total).

Term(s) Offered: Fall, Winter, Spring

^MUP141 - Symphony Orchestra

Credits - 1 Lab - 1

This course provides an opportunity to participate in the Oregon East Symphony, offering performances of a wide variety of orchestral styles.

Instructor approval required. Course is repeatable up to 3 times (3 credits total).

^MUP168 - Applied Woodwinds

Credits - 1 Lecture - 1

Individual private instruction is given in technical and stylistic aspects of artistic solo performance. Students enroll for a one-half hour lesson each week in their major instrument each term.

Course is repeatable up to 3 times (3 credits total).

^MUP169 - Applied Brass

Credits - 1 Lecture - 1

Individual private instruction is given in technical and stylistic aspects of artistic solo performance. Students enroll for a one-half hour lesson each week in their major instrument each term. Course is repeatable up to 3 times (3 credits total).

Course is repeatable up to 3 times (3 credits total).

^MUP170 - Applied Strings

Credits - 1 Lecture - 1

Individual private instruction is given in technical and stylistic aspects of artistic solo performance. Students enroll for a one-half hour lesson each week in their major instrument each term.

Instructor Approval. Course is repeatable up to 3 times (3 credits total).

Term(s) Offered: Fall, Winter, Spring

MUP Music

^MUP171 - Applied Piano

Credits - 1 Lecture - 1

Individual private instruction is given in technical and stylistic aspects of artistic solo performance. Students enroll for a one-half hour lesson each week in their major instrument each term. Course is repeatable up to 3 times (3 credits total).

Term(s) Offered: Fall, Winter, Spring

^MUP173 - Applied Organ

Credits - 1 Lecture - 1

Individual private instruction is given in technical and stylistic aspects of artistic solo performance. Students enroll for a one-half hour lesson each week in their major instrument each term.

Course is repeatable up to 3 times (3 credits total).

^MUP174 - Applied Voice

Credits - 1 Lecture - 1

Individual private instruction is given in technical and stylistic aspects of artistic solo performance. Students enroll for a one-half hour lesson each week in their major instrument each term.

Course is repeatable up to 3 times (3 credits total).

Term(s) Offered: Fall, Winter, Spring

^MUP191 - Applied Percussion

Credits - 1 Lecture - 1

Individual private instruction is given in technical and stylistic aspects of artistic solo performance. Students enroll for a one-half hour lesson each week in their major instrument each term.

Course is repeatable up to 3 times (3 credits total).

^MUP205 - Jazz Ensemble

Credits - 1 Lab - 1

Provides an opportunity for students to rehearse and perform current jazz and jazz standard literature. Course is repeatable up to 3 times (3 credits total).

Prerequisite: 3 terms of MUP105.

Course is repeatable up to 3 times (3 credits total).

^MUP215 - General Ensemble

Credits - 1 Lab - 1

Provides an opportunity for students to rehearse and perform in a select small ensemble.

Prerequisite: 3 terms of MUP115.

Course is repeatable up to 3 times (3 credits total).

MUP Music

^MUP222 - Concert Choir

Credits - 1 Lab - 1

To provide the skilled vocalist an opportunity to participate in a select group.

Prerequisite: 3 terms of MUP122.

Course is repeatable up to 3 times (3 credits total).

^MUP225 - Vocal Jazz Ensemble

Credits - 1 Lab - 1

An opportunity for advanced vocalists to perform literature of the popular and/or vocal jazz styles.

Prerequisite: MUP125 and instructor approval.

Course is repeatable up to 3 times (3 credits total).

Term(s) Offered: Fall, Winter

^MUP241 - Symphony Orchestra

Credits - 1 Lab - 1

This course provides an opportunity to participate in the Oregon East Symphony, offering performance of a wide variety of orchestral styles.

Prerequisite: Three quarters of MUP141.

Course is repeatable up to 3 times (3 credits total).

Term(s) Offered: Fall, Spring

^MUP268 - Applied Woodwinds

Credits - 1 Lecture - 1

Individual private instruction is given in technical and stylistic aspects of artistic solo performance. Students enroll for a one-half hour lesson each week in their major instrument each term.

Prerequisite: MUP168.

Course is repeatable up to 3 times

^MUP269 - Applied Brass

Credits - 1 Lecture - 1

Individual private instruction is given in technical and stylistic aspects of artistic solo performance. Students enroll for a one-half hour lesson each week in their major instrument each term.

Prerequisite: 3 terms of MUP169.

Course is repeatable up to 3 times (3 credits total).

^MUP270 - Applied Strings

Credits - 1 Lecture - 1

Individual private instruction is given in technical and stylistic aspects of artistic solo performance. Students enroll for a one-half hour lesson each week in their major instrument each term.

Instructor Approval.

Term(s) Offered: Fall, Winter, Spring

MUP Music

^MUP271 - Applied Piano

Credits - 1 Lecture - 1

Individual private instruction is given in technical and stylistic aspects of artistic solo performance. Students enroll for a one-half hour lesson each week in their major instrument each term.

Prerequisite: MUP171.

Course is repeatable up to 3 times

Term(s) Offered: Fall, Winter, Spring

^MUP273 - Applied Organ

Credits - 1 Lecture - 1

Individual private instruction is given in technical and stylistic aspects of artistic solo performance. Students enroll for a one-half hour lesson each week in their major instrument each term.

Prerequisite: MUP173.

Course is repeatable up to 3 times

^MUP274 - Applied Voice

Credits - 1 Lecture - 1

Individual private instruction is given in technical and stylistic aspects of artistic solo performance. Students enroll for a one-half hour lesson each week in their major instrument each term.

Prerequisite: MUP174.

Course is repeatable up to 3 times

Term(s) Offered: Fall, Winter, Spring

^MUP291 - Applied Percussion

Credits - 1 Lecture - 1

Individual private instruction is given in technical and stylistic aspects of artistic solo performance. Students enroll for a one-half hour lesson each week in their major instrument each term.

Prerequisite: MUP191.

Course is repeatable up to 3 times

MUS Music

^MUS101 - Fundamentals of Music

Credits - 2 Lecture - 2

Elementary study of terms and notation symbols designed to develop elementary competence in performing from notation and in notating musical ideas.

Term(s) Offered: Fall, Spring

^MUS105 - Music Appreciation

Credits - 3 Lecture - 3

A general survey of music in the Western European Art Music tradition. Music will be discussed with regard to historical events, trends, introduction and development of forms and major composers of each era.

Term(s) Offered: Fall

MUS Music

^MUS107 - Studio Recording Techniques

Credits - 2 Lecture - 2

A course for training in the use of recording and sound reinforcement equipment. This course covers terminology, technology, and recording as well as sound reinforcement procedures and practices.

^MUS108 - Studio Recording Techniques

Credits - 2 Lecture - 2

A hands on course for training in the use of recording and sound reinforcement equipment. This course includes the use and care of microphones, effect units, multitrack recorders and soundboards.

Prerequisite: MUS107

Term(s) Offered: Spring

^MUS109 - Studio Recording Techniques

Credits - 2 Lecture - 2

A hands on course for training in the use of recording and sound reinforcement equipment. This course applies principles learned in MUS107 and 108 to complete recording and live sound special projects.

Prerequisite: MUS108

^MUS111 - Music Theory

Credits - 4 Lecture - 4

This course introduces the building blocks of music, including intervals, key signatures, and the fundamental aspects of melody, harmony and rhythm.

Corequisite: MUS114.

Students with limited piano skills should take MUS131 as corequisite.

Term(s) Offered: Fall, Winter

^MUS112 - Music Theory

Credits - 4 Lecture - 4

This course develops the facility of harmony recognition and basic building of chord progressions using standard principles.

Prerequisite: MUS111 *Corequisite:* MUS115

Term(s) Offered: Spring

^MUS113 - Music Theory

Credits - 4 Lecture - 4

This course continues the development of basic music analysis and composition of chord progression including extended chords and modulations.

Prerequisite: MUS112 *Corequisite:* MUS116

Term(s) Offered: Fall, Spring

Symbols:

* - Discipline Studies ^ - Elective
 @ - Computer Literacy + - Lab Science
 ~ - Cultural Awareness > - C/T Elective

Course Descriptions

MUS

Music

^MUS114 - Ear Training and Sight Singing

Credits - 1 Lecture - 1

This course introduces the fundamentals of singing, dictating, and reading music without accompaniment. It stresses music terminology, rhythms, and intervals.

Corequisite: MUS111

^MUS115 - Ear Training and Sight Singing

Credits - 1 Lecture - 1

This course offers practice in singing, dictating, and reading music without accompaniment. It stresses music terminology, rhythms, and intervals.

Prerequisite: MUS114 Corequisite: MUS112

^MUS116 - Ear Training and Sight Singing

Credits - 1 Lecture - 1

This course offers practice in singing, dictating, and reading music without accompaniment. It stresses harmonic dictation, melody that modulates, more advanced rhythms, and larger intervals.

Prerequisite: MUS115 Corequisite: MUS113

^MUS131 - Class Piano

Credits - 2 Lecture - 2

Classroom instruction in piano technique to fit the needs of beginners. This course assumes no piano experience.

Term(s) Offered: Fall, Winter, Spring

^MUS132 - Class Piano

Credits - 2 Lecture - 2

Classroom instruction in piano technique to fit the needs of beginners. This course progresses to both hands simultaneously in harmony and melody.

Prerequisite: MUS131

Term(s) Offered: Fall, Winter, Spring

^MUS133 - Class Piano

Credits - 2 Lecture - 2

Classroom instruction in piano technique extending the skills introduced in MUS 131 and 132 through practice and performance.

Prerequisite: MUS132

Term(s) Offered: Fall, Winter, Spring

^MUS135 - Class Voice

Credits - 2 Lecture - 2

Designed for beginners in vocal music, this course deals primarily with development of breath control, tone production, articulation and enunciation in a group situation. Classroom performance of song and study of song literature.

MUS

Music

^MUS198 - Special Studies

Credits - 1-3

Study of various topics in music.

Course is repeatable up to 3 times

^MUS201 - Introduction to Music and Its Literature

Credits - 3 Lecture - 3

Enjoyment and understanding of music through listening and study of its elements, forms, and historical styles from its origins through 1750.

^MUS202 - Introduction to Music and Its Literature

Credits - 3 Lecture - 3

Enjoyment and understanding of music through listening and study of its elements, forms, and historical styles. Music and composers from 1750 to 1850.

^MUS203 - Introduction to Music and Its Literature

Credits - 3 Lecture - 3

Enjoyment and understanding of music through listening and study of its elements, forms, and historical styles. Music and composers from 1850 to the present.

*MUS205 - Introduction to Jazz History

Credits - 4 Lecture - 4

This course will chronologically survey prominent jazz styles and musicians of the 20th century. Listening will be a large part of the coursework.

Prerequisite: WR115 or Placement

NOTE: Prerequisite is for spring term only; WR060 or placement winter term.

Term(s) Offered: Fall, Spring

*MUS206 - Introduction to History of Rock Music

Credits - 4 Lecture - 4

A general survey of the history of rock and roll music. Beginning with its roots in African-American folk blues, this course will follow socio-political events that shaped the development of this popular genre. Also to be discussed will be typical instrumental groups, history of electronic amplification of string and keyboard instruments, development of form and lyric content, as well as marketing trends that shape content and intention of rock.

Prerequisite: WR115 or Placement

NOTE: Prerequisite is for spring term only; WR060 or placement winter term.

Term(s) Offered: Fall, Winter, Spring

MUS

Music

*MUS207 - History of Folk Music

Credits - 4 Lecture - 4

A survey of Anglo-American folk music and its subsequent styles from the first collected folk songs of Cecil Sharp (around 1900) to the present. Beginning with the Appalachian instrumental and vocal traditions, later folk-based styles will be discussed including country music, folk protest, bluegrass, folk rock, and progressive folk. Also to be discussed will be characteristics of the Anglo-American style with musical retentions from British Isles.

Prerequisite: WR115 or Placement

NOTE: Prerequisite is for spring term only; WR060 or placement winter term.

Term(s) Offered: Fall, Winter, Spring

^MUS211 - Music Theory

Credits - 3 Lecture - 3

Continues studies from the MUS 111, 112 and 113 sequence, with emphasis upon review and analysis and composition of 16th century musical styles and trends.

Prerequisite: MUS111, 112, 113

^MUS212 - Music Theory

Credits - 3 Lecture - 3

Continues studies on the elements of music, with emphasis upon analysis of music of the Classical period. Analysis of chord structures, basic modulations, and formal analysis will be stressed.

Prerequisite: MUS211

^MUS213 - Music Theory

Credits - 3 Lecture - 3

Continues studies on the elements of music, with emphasis upon analysis of music from the Romantic period. Analysis of extended chord structures, advanced modulations, and altered chords will be stressed.

Prerequisite: MUS212

^MUS298 - Special Studies

Credits - 1-3

Selected topics in music including pedagogy, conducting and performance practice.

NRS

Nursing

>NRS110 - Foundations of Nursing - Health Promotion

Credits - 9 Lecture - 5 Lab - 4

This course introduces the learner to the OCNE framework and emphasizes health promotion across the life span, including self-health and client health practices. Students will apply growth and development theory, culturally-sensitive client interview, and reflective thinking in the teamwork setting. The family experiencing a normal pregnancy is a major

Admission in the nursing program required

Term(s) Offered: Fall

Symbols:

* - Discipline Studies ^ - Elective
 @ - Computer Literacy + - Lab Science
 ~ - Cultural Awareness > - C/T Elective

NRS Nursing

>NRS111 - Foundations of Nursing in Chronic Illness I

Credits - 6 Lecture - 2 Lab - 4

This course introduces assessment and common interventions for clients with chronic illnesses common across the life span in major ethnic groups. The client and family's lived experience of the illness, coupled with clinical practice guidelines and extant research evidence is used to guide clinical judgments in care to the chronically ill. Roles of the multidisciplinary team in care of the chronically ill, and legal aspects of delegation are explored. Through case scenarios, cultural, ethical, health policy and health care delivery system issues are explored in the context of chronic illness care.

Term(s) Offered: Winter

>NRS112 - Foundations of Nursing in Acute Care I

Credits - 6 Lecture - 2 Lab - 4

This course introduces the learner to assessment and common interventions (including relevant technical procedures) for care of patients across the lifespan who require acute care, including normal childbirth. Disease/illness trajectories and their translation into clinical practice guidelines and/or standard procedures are considered in relation to their impact on providing culturally sensitive, client-centered care.

Term(s) Offered: Spring

>NRS221 - Foundations of Nursing in Chronic Illness II/End of Life

Credits - 9 Lecture - 4 Lab - 5

This course focuses on the evidence base related to family care-giving and symptom management which is a basis for nursing interventions with patients and families. This includes ethical issues related to advocacy, self determination and autonomy along with symptom management, negotiating in teams, chronic mental illness, chronic conditions, disabilities affecting functional status and cultural belief impacts within the context of client and family-centered care.

Prerequisite: NRS112

Term(s) Offered: Fall

NRS Nursing

>NRS222 - Foundations of Nursing in Acute Care II/End of Life

Credits - 9 Lecture - 4 Lab - 5

This course focuses on more complex patient care situations, requiring strong life or death recognition skills and rapid decision making. This includes evidence base supporting appropriate focused assessments and effective, efficient nursing interventions, and life span and developmental factors, cultural variables, and legal aspects of care effecting ethical decision-making employed in patient choices within the acute care setting. Case scenarios incorporate prioritizing care needs, delegation and supervision, family and patient teaching for discharge planning or end of life care.

Term(s) Offered: Winter

>NRS224 - Scope of Practice/Integrated Practicum

Credits - 9 Lecture - 2 Lab - 7

This course is designed to formalize the clinical judgment, knowledge and skills necessary in safe registered nurse practice. The preceptor model provides a context that allows the student to experience the nursing work world in a selected setting, balancing the demands of a job and life long learner. Faculty/preceptor/student analysis and reflection throughout the experience provide the student with evaluative criteria against which they can judge their own performance and develop a practice framework.

Required for AAS and eligibility for RN licensure.

Term(s) Offered: Spring

>NRS230 - Clinical Pharmacology I

Credits - 3 Lecture - 3

This course introduces the theoretical background that enables students to provide safe and effective care related to drugs and natural products to persons throughout the lifespan. Students will learn to make selected clinical decisions regarding medication administration using current, reliable sources of information. An understanding of pharmacokinetics and pharmacodynamics are explored. Drugs are studied by therapeutic or pharmacological class using an organized framework, with attention to physiological conditions, including anxiety and depression.

Term(s) Offered: Winter

NRS Nursing

>NRS231 - Clinical Pharmacology II

Credits - 3 Lecture - 3

This sequel to Clinical Pharmacology I continues to provide the theoretical background that enables students to provide safe and effective care related to drugs and natural products to persons throughout the lifespan. Students will learn to make selected clinical decisions regarding using current, reliable sources of information and evaluating the effectiveness of drug therapy. The course addresses additional classes of drugs and related natural products and physiological conditions not contained in Clinical Pharmacology I.

Prerequisite: NRS230, Corequisite: NRS112, NRS233

Term(s) Offered: Spring

>NRS232 - Pathophysiological Processes I

Credits - 3 Lecture - 3

This course introduces pathophysiological processes that contribute to many different disease states across the lifespan and human responses to those processes. Students will focus on current, reliable sources of pathophysiological information. Content will include the selection and interpretation of physical assessments of diverse populations.

Prerequisite: NRS110, Corequisite: NRS111, NRS230

Term(s) Offered: Winter

>NRS233 - Pathophysiological Processes II

Credits - 3 Lecture - 3

This sequel to Pathophysiological Processes I continues to explore pathophysiological processes that contribute to disease states across the lifespan and human responses to those processes. Students will focus on current, reliable sources of pathophysiological information. Content will continue to include the selection and interpretation of physical assessments of diverse populations.

Prerequisite: NRS232, Corequisite: NRS112, NRS231

Term(s) Offered: Spring

PE Health/Physical Education

PE090 - Physical Education

Credits - 1 Other - 1

Program of study and activity in a specific area of physical education to include introduction to guidelines and techniques of the stated activity. This pre-college level is designed for less complex activities focusing on physical fitness. Students will take part in the activity to maintain physical fitness.

Term(s) Offered: Winter

Symbols:	
* - Discipline Studies	^ - Elective
@ - Computer Literacy	+ - Lab Science
~ - Cultural Awareness	> - C/T Elective

Course Descriptions

PE Health/Physical Education

*PE131 - Introduction to Physical Education

Credits - 3 Lecture - 3

An introduction to the fields of Health, Physical Education, Recreation and Sports Management including professional opportunities and required academic qualifications. The course includes a "shadow" experience and information regarding American College of Sports Medicine and American Council on Exercise certifications.

Term(s) Offered: Winter

*PE185 - Physical Education Activity

Credits - 1 Other - 1

Program of study and activity in a specific area of physical education to include introduction to rules, principles, guidelines, and techniques of the stated activity. Students will take part in the activity to better learn about it as well as to maintain physical fitness.

Repeatable for a maximum of 12 credits

Term(s) Offered: Fall, Winter, Spring

^PE198 - Special Studies

Credits - 1-3

Selected studies in health and physical education.

^PE280 - Cooperative Work Experience

Credits - 1-8

An introduction to working in the field of physical education. Students set work objectives with their supervisors and are then graded according to fulfilling those objectives, as well as work habits, attendance, leadership, performance, etc. Work areas include lifeguarding, swimming instruction, P.E. teaching assistance, coaching assistance, and recreational facilities management.

Term(s) Offered: Winter

*PE290 - Lifeguard Training Review

Credits - 1 Lab - 1

The purpose of this course is to update student's American Red Cross certification in Lifeguard training (PE 291). Students who possess a current ARC Lifeguard Training certificate are eligible to enroll in this review course. Offered Winter Term Only.

Recommended preparation: The student must possess a current ARC Lifeguard Training Certificate

PE Health/Physical Education

*PE291 - Lifeguard Training

Credits - 2 Other - 2

This course is designed to provide lifeguard candidates and lifeguards with the skills and knowledge necessary to keep the patrons of aquatic facilities safe in and around the water. Successful completion will lead to the American Red Cross lifeguard training certificate.

Recommended preparation: The student must possess strong swimming skill proficiency and strength.

Term(s) Offered: Fall, Winter, Spring

*PE292 - Water Safety Instructor/WSI

Credits - 2 Lecture - 1 Other - 1

The student will learn how to teach swimming and water safety and further develop personal skills in these areas. Successful completion leads to the American Red Cross Water Safety Instructor (WSI) certificate.

Recommended preparation: Student must be at least 17 years old at the start of course and must pass the pre-course written and skills test.

*PE293 - Lifeguard Instructor Training/LGI

Credits - 2 Lecture - 1 Other - 1

The purpose of this course is to train candidates to teach the American Red Cross Lifeguard Training, Lifeguard Training Review, Community Water Safety, CPR for the professional rescuer and Lifeguarding Instructor Aid courses. Successful completion leads to the American Red Cross Lifeguard Instructor (LGI) certificate.

Recommended preparation: Student must be at least 17 years old at the start of course and must pass two pre-course written exams and four skill scenarios.

PHC Nursing

>PHC211 - Pharmacology

Credits - 2 Lecture - 2

This course is designed to provide the nursing student with background to understand actions of drugs in the human body. It provides the opportunity for the student to develop knowledge of nursing implications related to the administration of specific medication and follow-up care of patients. Included are current concepts of pharmacology and their relationship to patient care. The basic principles of pharmacology, drug actions, indications, contraindications, toxicity, side effects, pharmacodynamics and therapeutic dosage range of some groups of drugs are explored. Application of principles are included in the clinical setting.

Prerequisite: MTH095, NUR101 and NUR254

PHC Nursing

>PHC212 - Pharmacology

Credits - 2 Lecture - 2

This course is designed to provide the nursing student with background to understand actions of drugs in the human body. It provides the opportunity for the student to continue to develop knowledge of nursing implications related to the administration of specific medications. medication and follow-up care of patients. Included are current concepts of pharmacology and their relationship to patient care. The drug actions, indications, contraindications, toxicity, side effects, pharmacodynamics and therapeutic range of drugs are explored. Application of principles are included in the clinical setting.

Prerequisite: MTH095, NUR102 and PHC211

PHL English

*PHL101 - Introduction to Philosophy

Credits - 4 Lecture - 4

Introduces the student to major issues in philosophy, a historical overview and sub-genres of the philosophical tradition.

Prerequisite: WR115 or Placement

Recommended preparation: WR121 NOTE: Prerequisite is for spring term only; WR060 or placement winter term.

Term(s) Offered: Fall

*PHL102 - Introduction to Philosophy

Credits - 4 Lecture - 4

Emphasizes significant issues and explores responses to problems associated with social and political philosophy.

Prerequisite: WR115 or Placement

Recommended preparation: WR121 NOTE: Prerequisite is for spring term only; WR060 or placement winter term.

Term(s) Offered: Winter

^PHL103 - Introduction to Philosophy

Credits - 3 Lecture - 3

Emphasizes critical thinking in the examination of particular philosophical issues and problems.

Recommended preparation: WR121

Term(s) Offered: Spring

PHY Science

+PHY101 - Essentials of Physics

Credits - 4 Lecture - 3 Lab - 1

This problem-solving course deals with vectors, force, motion, energy, and properties of materials. Students will be expected to submit laboratory reports, homework and will take quizzes and examinations.

Prerequisite: MTH070 or Placement

Term(s) Offered: Winter, Spring

Symbols:

* - Discipline Studies ^ - Elective
 @ - Computer Literacy + - Lab Science
 ~ - Cultural Awareness > - C/T Elective

PHY Science

^PHY198 - Special Studies

Credits - 1-3

This course provides an opportunity for a student to participate in either a seminar or laboratory project outside of the regular class situation. The number of credits is variable and will be arranged by the instructor.

+PHY201 - General Physics

Credits - 5 Lecture - 4 Lab - 1

An introductory laboratory course dealing with mechanics, sound, heat, light, electricity, and modern physics.

Prerequisite: WR115 or Placement and MTH111 or Placement and MTH084 or MTH112 as Co-requisite

Preferred Prerequisite: WR227

Term(s) Offered: Fall

+PHY202 - General Physics

Credits - 5 Lecture - 4 Lab - 1

An introductory laboratory course dealing with mechanics, sound, heat, light, electricity, and modern physics.

Prerequisite: PHY201 or PHY211 and MTH084 or MTH112

Term(s) Offered: Winter

+PHY203 - General Physics

Credits - 5 Lecture - 4 Lab - 1

An introductory laboratory course dealing with mechanics, sound, heat, light, electricity, and modern physics.

Prerequisite: PHY202 or PHY212

Term(s) Offered: Spring

+PHY211 - General Physics with Calculus

Credits - 5 Lecture - 4 Lab - 1

An examination of mechanics, sound, heat, light, electricity, and magnetism. This course is recommended for physics majors, engineering majors, and other science students with a calculus background.

Prerequisite: WR115 or Placement

Corequisite: MTH251, Preferred Prerequisite: WR227

Term(s) Offered: Fall

+PHY212 - General Physics with Calculus

Credits - 5 Lecture - 4 Lab - 1

An examination of mechanics, sound, heat, light, electricity, and magnetism. This course is recommended for physics majors, engineering majors, and other science students with a calculus background.

Prerequisite: PHY211 and MTH251

Term(s) Offered: Winter

PHY Science

+PHY213 - General Physics with Calculus

Credits - 5 Lecture - 4 Lab - 1

An examination of mechanics, sound, heat, light, electricity, and magnetism. This course is recommended for physics majors, engineering majors, and other science students with a calculus background.

Prerequisite: PHY212 and MTH252

Term(s) Offered: Spring

PS Social Science

^PS198 - Special Studies

Credits - 1-3

Designed to provide interested and capable students with the opportunity to study special topics in political science.

Recommended preparation: WR060

***PS201 - American Government and Politics**

Credits - 4 Lecture - 4

This course begins by examining the Constitutional principles of the United States government. Students will learn about the decision making process behind American politics.

Prerequisite: WR115 or Placement

NOTE: Prerequisite is for spring term only; WR060 or placement winter term.

Term(s) Offered: Fall

***PS202 - American Government and Politics**

Credits - 4 Lecture - 4

This course will provide an overview of American political institutions. Students will study individual rights and liberties. The term concludes with an examination of current national policy issues.

Prerequisite: WR115 or Placement

NOTE: Prerequisite is for spring term only; WR060 or placement winter term.

Term(s) Offered: Winter

***PS203 - American Government/State and Local**

Credits - 4 Lecture - 4

Examines politics and government in the American states. Emphasis will be on the State of Oregon.

Prerequisite: WR115 or Placement

NOTE: Prerequisite is for spring term only; WR060 or placement winter term.

Term(s) Offered: Spring

PSY Social Science

PSY Social Science

^PSY119 - Process In Living

Credits - 3 Lecture - 3

This course surveys the areas of personality development and psychology. Specific topics include: ages and stages of the lifespan, theories of personality, self-awareness, health and stress, and influences on development.

Recommended preparation: WR060

Term(s) Offered: Winter

^PSY198 - Special Studies

Credits - 1-3

Offers topics of study in psychology with individual research or field study.

Recommended preparation: WR060

***PSY201 - General Psychology**

Credits - 4 Lecture - 4

A survey of the basic concepts and principles of psychology. Specific topics include: the history of psychology and research methods of psychology; the biological basis of behavior, sensory and perceptual processes; states of consciousness including sleep and dreams; learning, memory, and intelligence. Emphasis is both theoretical and applied.

Prerequisite: WR115 or Placement

NOTE: Prerequisite is for spring term only; WR060 or placement winter term.

Term(s) Offered: Fall, Winter, Spring

***PSY202 - General Psychology**

Credits - 4 Lecture - 4

A survey of the basic concepts and principles of psychology. Specific topics include: motivation, emotion, stress & health, human development, personality, psychological disorder and treatment, and social psychology. Emphasis is on both theory and application.

Prerequisite: WR115 or Placement, PSY201

NOTE: Prerequisite is for spring term only; WR060 or placement winter term.

Term(s) Offered: Winter, Spring

***PSY237 - Human Development**

Credits - 4 Lecture - 4

A life-span examination of change and consistency as people age. Studies the stages of conception to birth, infancy, childhood, adolescence and adulthood as influenced by maturation and socialization. Includes discussion of research strategies and theories of behavior.

Prerequisite: WR115 or Placement, PSY201

NOTE: Prerequisite is for spring term only; WR060 or placement winter term.

Term(s) Offered: Fall, Winter, Spring

RD College Prep

Symbols:	
* - Discipline Studies	^ - Elective
@ - Computer Literacy	+ - Lab Science
~ - Cultural Awareness	> - C/T Elective

Course Descriptions

RD College Prep

RD090 - Effective Reading Strategies

Credits - 3 Lecture - 3

This course provides directed practice in the development of college reading skills, emphasizing vocabulary skills, comprehension skills, advanced reading skills, and reading for study. Vocabulary skills include dictionary use, word components and etymology, context clues, and multiple meanings of words. Comprehension skills include main ideas and supporting details which signal key concepts and ideas.

Term(s) Offered: Fall

^RD101 - College Textbook Reading

Credits - 3 Lecture - 3

This course focuses on improving reading and thinking skills through guided reading instruction and extensive guided-practice with academic discipline-based readings. Students will increase college level vocabulary, use effective textbook reading techniques, practice note taking skills, and reading for study. Reading for study includes effective textbook study methods, outlining, study mapping, summarizing, and textbook graphics.

Term(s) Offered: Fall, Winter, Spring

^RD120 - Critical Reading and Thinking

Credits - 3 Lecture - 3

This course will sharpen students' abilities to think and read clearly, logically, critically, and effectively. Students will develop analytical skills necessary for problem solving and making the best choices in their academic, career, and personal lives. Students regularly interact in group discussions about the thinking and reading process.

Term(s) Offered: Fall, Winter, Spring

^RD220 - Advanced Critical Reading & Thinking

Credits - 3 Lecture - 3

Students will explore the structure of critical thinking, how to evaluate their own thinking and the thinking of other perspectives using a systematic, disciplined approach. Students will examine critical concepts, questions, and ideas that lead to the further development of critical and ethical reasoning skills and abilities.

Prerequisite: RD120

RNG Agriculture

>RNG241 - Range Management

Credits - 3 Lecture - 2 Lab - 1

Plants and domesticated farm animals: the integration of climate, soil, vegetation, and animal factors in the economic management of a range ecosystem.

Term(s) Offered: Spring

SOC Social Science

Symbols:

* - Discipline Studies ^ - Elective
@ - Computer Literacy + - Lab Science
~ - Cultural Awareness > - C/T Elective

SOC Social Science

^SOC198 - Special Studies

Credits - 1-3

This course is designed to provide interested and capable students special topics in sociology.

Recommended preparation: WR060

~*SOC204 - General Sociology

Credits - 4 Lecture - 4

This course is a sociological study of social group behavior and social structures, emphasizing diversity and commonalities among groups within society. Topics are examined through the framework of sociological perspectives, encouraging critical thinking and personal responsibility about social issues.

Prerequisite: WR115 or Placement

This is the foundational course for all other Sociology offerings. NOTE: Prerequisite is for spring term only; WR060 or placement winter term.

Term(s) Offered: Fall, Winter, Spring

~*SOC205 - General Sociology/Institutions and Social Change

Credits - 4 Lecture - 4

This course introduces the following major social institutions: family, religion, education, economics, politics, and health care and the problems and issues existing within each. The focus is on modern American society and the impact of social change on major institutions.

Prerequisite: WR115 or Placement

NOTE: Prerequisite is for spring term only; WR060 or placement winter term.

Term(s) Offered: Fall, Winter, Spring

~*SOC213 - Minorities

Credits - 4 Lecture - 4

A survey of minority groups, with special emphasis on local groups in which causes and consequences of minority status are examined. By confronting the pervasive nature of prejudice and discrimination, we will explore the dynamics of institutionalized racism, focusing specifically on race relations within our social institutions. The political, economic, and social lives of several groups - White Ethnic Americans, Native Americans, Asian Americans, Latinos and African Americans.

Prerequisite: WR115 or Placement

Recommended preparation: SOC204. NOTE: Prerequisite is for spring term only; WR060 or placement winter term.

Term(s) Offered: Fall, Winter, Spring

SOC Social Science

~*SOC217 - Family and Society

Credits - 4 Lecture - 4

This course covers the historical development of the family as an institution, its structure and functions, and changes in contemporary American society. Emphasis is placed on changes that produce societal and individual stress.

Prerequisite: WR115 or Placement

Recommended preparation: SOC204. NOTE: Prerequisite is for spring term only; WR060 or placement winter term.

Term(s) Offered: Fall, Spring

SPAN Foreign Languages

^SPAN101 - First Year Spanish

Credits - 4 Lecture - 4

Introduction to Spanish, stressing speaking and reading. Exercises in elementary composition and grammar.

Term(s) Offered: Fall, Winter

^SPAN102 - First Year Spanish

Credits - 4 Lecture - 4

Continued introduction to Spanish, stressing speaking and reading. Exercises in elementary composition and grammar.

Prerequisite: SPAN101 or instructor approval

Term(s) Offered: Winter, Spring

^SPAN103 - First Year Spanish

Credits - 4 Lecture - 4

Continued introduction to Spanish, stressing speaking and reading. Exercises in elementary composition and grammar.

Prerequisite: SPAN102 or instructor approval

Term(s) Offered: Spring

*SPAN201 - Second-Year Spanish

Credits - 4 Lecture - 4

Intensive oral and written exercises designed to help the student acquire an accurate and fluent use of Spanish. Selections from representative authors are studied.

Prerequisite: SPAN103 or instructor approval

Term(s) Offered: Fall

*SPAN202 - Second-Year Spanish

Credits - 4 Lecture - 4

Intensive oral and written exercises designed to help the student acquire an accurate and fluent use of Spanish. Emphasis on advanced use of past tense and on hypothetical and persuasive language. We will also include literary selections.

Prerequisite: SPAN201 or instructor approval

Term(s) Offered: Winter

SPAN Foreign Languages

*SPAN203 - Second-Year Spanish

Credits - 4 Lecture - 4

Intensive oral and written exercises designed to help the student acquire an accurate and fluent use of Spanish. Emphasis on advanced verb moods and application of language.

Prerequisite: SPAN202 or instructor approval

Term(s) Offered: Spring

^SPAN211 - Spanish Conversation and Composition

Credits - 3 Lecture - 3

Intensive conversation and essay writing of a general character designed to improve oral and written ability in Spanish.

^SPAN212 - Spanish Conversation and Composition

Credits - 3 Lecture - 3

Intensive conversation and essay writing of a general character designed to improve oral and written ability in Spanish.

Prerequisite: SPAN211 or instructor approval

^SPAN213 - Spanish Conversation and Composition

Credits - 3 Lecture - 3

Intensive conversation and essay writing of a general character designed to improve oral and written ability in Spanish.

Prerequisite: SPAN212 or instructor approval

SUR Engineering Tech/Civil-Drafting

>SUR161 - Plane Surveying

Credits - 5 Lecture - 3 Lab - 2

Principles and practices of leveling, linear and angular measurements, Gaussian Error Theory applied to measurements, care and adjustment of instruments, note-keeping and manual and machine methods of computation, including use of calculators and electronic computers.

Prerequisite: Pre-requisite: MTH070 or higher

Term(s) Offered: Spring

>SUR162 - Surveying and Mapping

Credits - 5 Lecture - 3 Lab - 2

Field and office procedures in property surveying and preparation of plats and other maps; State Plane Coordinates, Solar observations, and GPS, legal elements of written and unwritten conveyances.

Prerequisite: SUR161

Term(s) Offered: Fall

SUR Engineering Tech/Civil-Drafting

>SUR166 - Highway Fundamentals

Credits - 3 Lecture - 3

A study of highway surveys, design standards, circular and vertical curves, curve transitions, earthworks and drainage.

Prerequisite: SUR162

Term(s) Offered: Winter

>SUR167 - Surveying Seminar

Credits - 3 Lab - 6

Focus on applied surveying techniques in a project oriented environment.

Prerequisite: SUR166

Credit hours provide student access to State licensing process.

Term(s) Offered: Spring

TA Theatre

*TA101 - Introduction to the Theatre

Credits - 4 Lecture - 4

This course provides an introduction to the world of the theatre by exploring the origins of drama, historical and contemporary styles of playwriting and theatrical performance, the components of a stage production, and the many functions of the artists and craftspeople who collaborate to make theatre happen.

Prerequisite: WR115 or Placement

NOTE: Prerequisite is for spring term only; WR060 or placement winter term.

Term(s) Offered: Fall, Winter, Spring

*TA141 - Fundamentals of Acting Techniques

Credits - 4 Lecture - 4

This course provides a basic introduction to contemporary acting theories and techniques. Through participation in acting exercises, improvisations, and prepared monologues and scenes, the student will learn fundamental acting terminology and be introduced to a variety of contemporary acting training philosophies.

Prerequisite: WR115 or Placement

NOTE: Prerequisite is for spring term only; WR060 or placement winter term.

Term(s) Offered: Fall

*TA142 - Fundamentals of Acting Techniques

Credits - 4 Lecture - 4

This course provides a continued exploration of contemporary acting theories and techniques via classroom activities and prepared presentations.

Prerequisite: WR115 or Placement

NOTE: Prerequisite is for spring term only; WR060 or placement winter term.

Term(s) Offered: Winter

TA Theatre

*TA143 - Fundamentals of Acting Techniques

Credits - 4 Lecture - 4

This course provides a continued exploration of contemporary acting theories and techniques via classroom activities and prepared presentations. Activities will include opportunities for public performance.

Prerequisite: WR115 or Placement

NOTE: Prerequisite is for spring term only; WR060 or placement winter term.

Term(s) Offered: Spring

^TA147 - Voice and Diction for the Theatre

Credits - 3 Lecture - 3

This studio course introduces all aspects of vocal production for the stage, including breathing, support, articulation and projection.

Recommended preparation: LA035

^TA165 - Technical Theatre Workshop

Credits - 3 Lab - 3

This course provides the opportunity to explore the various technical components of a theatrical production through hands-on participation in the off-stage activities necessary for the staging of a play.

May be repeated for a maximum of 9 credits.

Term(s) Offered: Fall, Winter, Spring

^TA180 - Theatre Rehearsal and Performance

Credits - 3 Lab - 3

This course provides credit for rehearsal and performance of a play.

May be repeated for a maximum of 9 credits.

Term(s) Offered: Fall, Winter, Spring

*TA241 - Intermediate Acting Techniques

Credits - 4 Lecture - 4

This course provides a second level of study of contemporary acting theories and techniques. Through participation in acting exercises, improvisations, and prepared monologues and scenes, the student will learn advanced acting terminology and further explore a variety of contemporary acting training philosophies.

Prerequisite: WR115 or Placement

NOTE: Prerequisite is for spring term only; WR060 or placement winter term.

Term(s) Offered: Fall

Symbols:

* - Discipline Studies ^ - Elective
 @ - Computer Literacy + - Lab Science
 ~ - Cultural Awareness > - C/T Elective

Course Descriptions

TA Theatre

*TA242 - Intermediate Acting Techniques

Credits - 4 Lecture - 4

This course provides an exploration of advanced contemporary acting theories and techniques via classroom activities and prepared presentations

Prerequisite: WR115 or Placement

May be taken without previous acting experience or coursework. NOTE: Prerequisite is for spring term only; WR060 or placement winter term.

Term(s) Offered: Winter

*TA243 - Intermediate Acting Techniques

Credits - 4 Lecture - 4

This course provides an exploration of advanced contemporary acting theories and techniques via classroom activities and prepared presentations. Activities will include opportunities to perform and direct stage productions to be presented to the public.

Prerequisite: WR115 or Placement

May be taken without previous acting experience or coursework. NOTE: Prerequisite is for spring term only; WR060 or placement winter term.

Term(s) Offered: Spring

TTL Diesel/Welding/PTD

>TTL101 - Introduction to Transportation and Logistics

Credits - 4 Lecture - 4

This course provides a comprehensive overview of the rules, regulations, and practices that apply to truck drivers and their companies. In combination with PTD121 which follows, the class provides the training necessary to take the Commercial Driver's License (CDL) exam. This class is 40 hours of classroom work over the period of a week.

>TTL121 - Practical Applications in Transportation and Logistics

Credits - 6 Lab - 6

This training course is the core preparation for a truck driver in preparation for taking the Commercial Driver's License (CDL) exam. There is 120 hours of lecture/lab, with a minimum of 44 hours of driving time over the period of 3 weeks.

Prerequisite: TTL101

>TTL141 - Transportation Customer Service Skills

Credits - 3 Lecture - 3

This course focuses on building skills in dealing with customers and others in the course of delivery in order to help create a more professional approach to dealing with the public.

TTL Diesel/Welding/PTD

>TTL280 - Cooperative Work Experience

Credits - 1-8

This course ensures the completion of additional truck driving experience necessary for excellent and reliable driving skills. It also covers the work processes and procedures at the student's employer's site. The student will participate in a 16-hour seminar and document 200 hours on the road, with 100 hours as the driver with the trainer in the second seat.

UMA Foreign Languages

^UMA101 - First Year Umatilla

Credits - 4 Lecture - 4

This course will introduce the student to the Umatilla language. Umatilla is a Sahaptin language primarily spoken on the Umatilla Indian Reservation. The student will learn the four areas that are essential to speaking grammatical phrases in Umatilla to reach novice level speaking proficiency with an emphasis in writing. Oral exercises will be coupled with grammar exercises to ensure students obtain a firm understanding of grammatical constructions of the Umatilla language.

WLD Diesel/Welding/PTD

>WLD111 - Basic Gas and Arc Welding

Credits - 3 Lab - 3

In introduction to welding practices including oxyacetylene welding and cutting, arc welding, welding rod identification and application, properties of metals, joint preparation, and weld faults and identification.

Term(s) Offered: Fall, Winter, Spring

>WLD112 - Advanced Arc Welding

Credits - 3 Lab - 3

An advanced level course for students who know welding safety, basic practices and terminology. Student will learn higher-level practices and improve their skills learned in the basic class.

Term(s) Offered: Fall, Winter, Spring

>WLD221 - TIG Welding

Credits - 3 Lab - 3

Designed for students who have basic level welding skills to introduce Tungsten Arc Welding techniques including the setup of equipment for the welding process.

Term(s) Offered: Fall, Winter, Spring

>WLD253 - Welding Practices for Certification

Credits - 3 Lab - 3

Designed for students who have advanced level arc welding skills to prepare for structural certification. Weld coupons will be tested and documented when they have passed the required weld strength and quality.

Term(s) Offered: Fall, Winter, Spring

WLD Diesel/Welding/PTD

>WLD256 - Pipe Welding for Certification

Credits - 3 Lab - 3

Designed for students who have advanced level arc welding skills to introduce pipe-welding techniques to prepare for pipe welding certification. Weld coupons will be tested and documented when they have passed the required weld strength and quality.

Term(s) Offered: Fall, Winter, Spring

WR English

WR060 - Elements of the Essay

Credits - 3 Lecture - 3

Introduces students to the academic essay. The course moves from developing clear, coherent paragraphs to composing and revising the academic essay. Students are encouraged to develop confidence in their writing, strengthen composing and editing skills, collaborate in the writing process, and practice critical thinking.

Prerequisite: LA035 or WR035 or Placement

Term(s) Offered: Fall, Winter, Spring

WR065 - Introduction to Technical Writing

Credits - 3 Lecture - 3

Introduces students to the basic elements of expository technical writing. Students will move from short, paragraph length technical works to multi-paragraph documents. Additional attention is directed toward integrating graphics into the writing, presenting the material orally and creating job search documents.

Prerequisite: LA035 or WR035 or Placement

Term(s) Offered: Fall, Winter, Spring

^WR115 - Introduction to College Writing

Credits - 4 Lecture - 4

This course introduces college-level critical inquiry in academic reading and writing. Students will work on developing their ability to read critically and write college-level essays in a variety of different writing contexts and situations. Emphasis is on learning to use the conventions of written language appropriately and skillfully for different purposes and to experience and use writing as a recursive, social and collaborative process.

Prerequisite: WR060 or WR065 or Placement

Term(s) Offered: Fall, Winter, Spring

Symbols:

* - Discipline Studies ^ - Elective
 @ - Computer Literacy + - Lab Science
 ~ - Cultural Awareness > - C/T Elective

WR English

***WR121 - English Composition**

Credits - 4 Lecture - 4

The first of two courses required by the AAOT degree, this course focuses on writing clear, detailed, informative essays in a variety of forms, correctly using and citing sources, active reading, and critical thinking.

Prerequisite: WR115 or Placement

NOTE: Prerequisite is for spring term only; WR060 or placement winter term.

Term(s) Offered: Fall, Winter, Spring

***WR122 - English Composition**

Credits - 4 Lecture - 4

The second of a two-course sequence, this course focuses on the development of student skills in evaluating and composing essays of various lengths, with emphasis on style of expression, logical thought and evidence, and argumentative approaches and strategies. The course also includes a research paper and supporting annotated bibliography.

Prerequisite: WR121

Term(s) Offered: Fall, Winter, Spring

^WR198 - Special Studies

Credits - 1-3

Designed to provide interested and capable students with the opportunity to study special topics in writing.

***WR227 - Technical Report Writing**

Credits - 4 Lecture - 4

Researching and reporting technical information including business proposals, business plans, feasibility studies and process instructions.

Prerequisite: WR121

Term(s) Offered: Fall, Winter, Spring

***WR241 - Introduction to Imaginative Writing**

Credits - 4 Lecture - 4

A course in creative writing designed for those who wish to express themselves in fiction, non-fiction, drama, poetry, or other imaginative forms.

Prerequisite: WR115 or Placement

NOTE: Prerequisite is for spring term only; WR060 or placement winter term.

Term(s) Offered: Fall

***WR242 - Introduction to Imaginative Writing**

Credits - 4 Lecture - 4

A course in creative writing designed for those who wish to express themselves in fiction, non-fiction, drama, poetry, or other imaginative forms.

Prerequisite: WR115 or Placement

NOTE: Prerequisite is for spring term only; WR060 or placement winter term.

Term(s) Offered: Winter, Spring

WR English

***WR243 - Introduction to Imaginative Writing**

Credits - 4 Lecture - 4

A course in creative writing designed for those who wish to express themselves in fiction, non-fiction, drama, poetry, or other imaginative forms. This course will focus on creative non-fiction.

Prerequisite: WR115 or Placement

NOTE: Prerequisite is for spring term only; WR060 or placement winter term.

Term(s) Offered: Spring

^WR298 - Special Studies

Credits - 1-3

Designed to provide interested and capable students with the opportunity to study special topics in writing.

Symbols:

- * - Discipline Studies ^ - Elective
- @ - Computer Literacy + - Lab Science
- ~ - Cultural Awareness > - C/T Elective

BMCC Boards & Personnel

Glossary

Campus Maps

Phone Directory

Academic Calendar

BMCC Boards and Personnel

BMCC Board of Education

Lea Mathieu
Zone 1, Term Expires 2015

Werner Buehler
Zone 2, Term Expires 2015

Ed Taber
Zone 3, Term Expires 2013

Kim Puzey
Zone 4, Term Expires 2013

Doug Voyles
Zone 5, Term Expires 2015

Dr. Anthony (Tony) Turner
Zone 6, Term Expires 2013

Bryan Branstetter
Zone 7, Term Expires 2015

Oregon Board of Education

Jerry Berger
Salem—5th Congressional District

Leslie Shepherd
Hammond—2nd Vice Chair—At Large

Brenda Frank
Klamath Falls—2nd Congressional District

Artemio Paz, Jr.
Springfield—4th Congressional District

Serilda Summers-McGee
Portland—At Large

Duncan Wyse
Portland—1st Congressional District

Samuel Henry
Portland—3rd Congressional District

Vacant
At large

BMCC Foundation Board of Directors

Bob Byrd
Irrigon, Term Expires 2012-

Gary Schmidtgall
Athena, Term Expires 2014

Russell Dorrان
Hermiston, Term Expires 2012

Deb Sue Hamby
Pendleton, Term Expires 2014

Nancy Snider
Heppner, Term Expires 2015

Kari Dallas-Spratling
Pendleton, Term Expires 2013

Tracy Gammell
Hermiston, Term Expires 2013

Betty Rietmann
Ione, Term Expires 2013

Carole Innes
Pendleton, Term Expires 2013

Ron Daniels
Keizer, Term Expires 2014

Ellsworth Mayer
Pendleton, Term Expires 2012

Dotty Miles
North Powder, Term Expires 2012

Lonnie Read
Pendleton, Term Expires 2013

Margaret Gianotti
Pendleton, Executive Director

Administration

John Turner (2003)

President
B.A., University of Oklahoma
M.A., Catholic University of America
Fellowship, MIT

Jaime Clarke (2011)

Associate Vice President, Corrections Education
M.A., Communications and Leadership Studies,
Gonzaga University

Art Doherty (2004)

Associate Vice President, Human Resources
B.A., Campbell University

Paul Erdmann (2011)

Associate Vice President, Information Technology
B.A., Chapman University

Harvey Franklin (2005)

Associate Vice President Enrollment Management
A.S., Central Oregon Community College
B.S., Oregon State University
M.S., Oregon State University
Ph.D., University of Oregon

Arthur Hill (2001)

Vice President, Economic Development
B.A., Boston University
M.B.A., University of Bridgeport

Peggy Hudson (2006)

Associate Vice President,
BMCC-Baker County
A.A., Central Oregon CC
B.B.A., University of Oregon
M.A., San Francisco State

Daniel Koopman (2010)

Associate Vice President
Instruction
B.A., Walla Walla College
M.Ed., University of Idaho
School of Administration

Daniel Lange (1983)

Vice President, Instruction
B.M., University of Montana
M.M., University of N. Colorado

Deborah Lee (2007)

Associate Vice President
BMCC Milton-Freewater
B.S., Oregon State University
M.Ed, Oregon State University

Margaret Saylor (1975)

Senior Associate Vice President,
BMCC-Hermiston/Boardman
B.S., Eastern Oregon University
M.A., Oregon State University

N. Clark Williams (2007)

Vice President, Operations
B.S., US Naval Academy
M.S., Stanford University



BMCC Faculty

(As of April 2012)

Lower Division Collegiate and Career & Technical Programs

Full-Time Faculty

Shaindel Beers (2006)

Instructor of English
B.A., Huntington College
M.A., University of Chicago
M.F.A., Vermont College of Fine Arts

Michael Booth (1989)

Instructor of Art
B.F.A., Utah State University
M.F.A., Utah State University

Andria Bye (2009)

Instructor of Nursing
A.A.S., Blue Mountain Community College
B.A., University of Phoenix
M.S.N., University of Phoenix

Lincoln A. DeBunce (1999)

Instructor of Geography and Anthropology
B.S., Southern Oregon University
B.S., Southern Oregon University
M.A., Louisiana State University
Ph.D., University of Oregon

Ann Marie Hardin (2009)

Instructor of Civil Engineering Technology
B.S., University of Idaho
M.S., University of Idaho

Robert L. Hillenbrand (1998)

Instructor of Mathematics
A.A., Seattle Central Community College
B.S., University of Washington
M.S., Western Washington University

Arlene G. Isaacson (1997)

Instructor of Education
B.A., Mt. Angel College
M.S., Indiana University
Ph.D., University of Oregon

Rob Johnson (2007)

Instructor of Diesel Technology
Certificate, Clark Community College

Llewellyn (Wells) Jones (1995)

Instructor of Physical Education
B.S., Lewis Clark State College
M.S., University of Oregon

Cheri Kendrick (2002)

Instructor of Speech and Business Technology
B.A., Oregon State University
M.A., Oregon State University
J.D., Willamette University of Law

Cindy A. Lenhart (1991)

Instructor of Education
B.S., Eastern Oregon University
M.S., Eastern Oregon University

Carol Lovell (2003)

Instructor of Nursing
B.S., Oregon Health Sciences University
MSN, University of Wyoming

Christina E. Martinez (1994)

Instructor of Sociology
B.A., California State University-Fullerton
M.A., California State University-Fullerton

Margaret M. Mayer (2001)

Instructor of Music
B.A., Linfield College
M.M., Michigan State University
Ph.D., University of California-Santa Barbara

Craig McIntosh (2005)

Instructor of Theatre Arts
B.A., Lewis and Clark
M.F.A., University of California

Michelle Miller (1995)

Instructor of Biology
B.S., University of Idaho
M.S., University of Oklahoma

Michael W. Muller (1991)

Instructor of Civil Engineering Technology
B.S., Eastern Oregon University
B.Arch., University of Idaho

Ron Neeley (2004)

Instructor of Business Technology
B.S., Eastern Oregon University
B.S., Central Washington University
M.B.A., Portland State University

Nick Nelson (2007)

Instructor of Animal Science
A.A., Lassen College
B.S., California State University
M.A., Oregon State University

Kristen Oja (2011)

Instructor of Biology
B.S., Linfield College
M.S., Oregon State University
PhD. Oregon State University

Gary D. Parker (1996)

Instructor of Mathematics
A.S., Community College of Rhode Island
B.A., Rhode Island College
M.S., Western Washington University

Crystal D. Patton-Doherty (1989)

Instructor of Dental Assisting
Certificate, Blue Mountain Community College
B.S., Eastern Oregon University

Melinda S. Platt (2002)

Instructor of Business Technology
B.S., Eastern Oregon University
M.T.E., Eastern Oregon University

Guy Post (1999)

Instructor of Mathematics
B.S., Oregon State University
M.S., Oregon State University

Laurie Post (2004)

Instructor of Nursing
A.S., Walla Walla Community College
B.S.N., Oregon Health Sciences University
M.S.N., Gonzaga University

Teresa L. Quesenberry (1986)

Instructor of Business Technology
B.S., Eastern Oregon University
M.S., University of Idaho

Sara Reyburn (2000)

Instructor of Psychology
B.S., Pittsburg State University
M.S., Pittsburg State University

Philip Schmitz (2008)

Instructor of Geology & Physics
B.S., University of Notre Dame
M.S., University of Utah

Kevin Seward (2007)

Instructor of Chemistry
B.A., Iowa State University
M.S., University of Wyoming

Elizabeth A. Sweet (1998)

Instructor of Dental Assisting
C.D.A., Portland Community College
B.A., DePaul University

Alison Timmons (2005)

Instructor of English
B.A., Washington State University/Columbia
Basin College
M.A., University of Manchester

Scott Waggoner (2008)

Instructor of Diesel Technology
A.A., Blue Mt Community College

Scott Wallace (1993)

Instructor of Business Technology
B.A., Brigham Young University
M.A., Brigham Young University

Dale J. Wendt (1979)

Instructor of Agriculture
B.S., California State Polytechnic University
M.S., California State Polytechnic University

James K. Whittaker (1996)

Instructor of Mathematics
B.S., Oregon State University
M.E., North Carolina State University
Ph.D., North Carolina State University

Preston H Winn (1991)

Instructor of Agriculture
B.S., Oregon State University
M.Ed., Oregon State University

Part-Time Faculty

Jennifer Abney (2011)

Instructor of Business Technology
A.A.O.T., Blue Mountain Community College
B.S., Eastern Oregon University
M.T.E., Eastern Oregon University

Patty Allery-Lane (2003)
Instructor of Mathematics
B.S., Eastern Oregon University
M.S., Eastern Oregon University

Brenda Appleton (2011)
Instructor of Mathematics
B.S., Eastern Oregon University

Lisa Atkinson (2010)
Instructor of Business Technologies
B.A., Oregon State University
J.D., University of Washington

Steven Bachman (2007)
Instructor of Human Anatomy & Physiology
B.S., University of Oregon
D.C., Western States Chiropractic College

Julie Bacon (2010)
Instructor of Speech
B.A., Washington State University
M.S., Central Washington University

Leslie Balsiger (2008)
Instructor of Criminal Justice
B.S., Eastern Oregon University
J.D., Gonzaga University School of Law

Dave Baty (2008)
Head Volleyball Coach
Instructor of Physical Education

Tim Beinert (2011)
Instructor of Business Technology
B.S., University of Indiana
M.P.A., Valdosta State University

Gregory A. Berlie (1986)
Instructor of English
B.A., California State University
M.A., California State University

Rebecca Blaine (2009)
Instructor of Criminal Justice
B.A., California State University
M.A., State University of New York

Roy Blaine (2010)
Instructor of Criminal Justice
B.A., California State University
M.A., State University of New York

Gayle Blomme (2009)
Instructor of English
B.A., Oakland University
M.A., University of Michigan
PhD., University of Michigan

Susan Bower (2008)
Instructor of Business Technology
B.A., Otterbein College
M.B.A., John Carroll University

Ron Brand (2011)
Instructor of Communications
B.A., University of Illinois
M.A., Northeastern Illinois University

Brett Bryan (1993)
Instructor of Physical Education
B.S., Eastern Oregon University

Lynden Bryson (2012)
Instructor of Education
B.A., Linfield College
M.A.T., Grand Canyon University

Janie Burcart (2007)
Instructor of Criminal Justice
B.A., University of Sussex
M.A., University of New Mexico

Gary Burnett (2010)
Instructor of Civil Engineering Technology
B.S., Oregon State University

Billie Burns (1999)
Instructor of Health & Physical Ed
B.S., Oregon State University
M.A., University of New Mexico

Jerald Carlson (2008)
Instructor of Biology
A.A., Clackamas Community College
B.A., Western Oregon State College
M.A., Western Oregon State College

Kari Carter (2002)
Instructor of Math
B.S., Oregon State University
M.S.T., Portland State University

Webster Castaneda (2004)
Instructor of Spanish
B.A. Eastern Washington University
M.Ed., Washington State University

Jenny Chavez (2009)
Instructor of Early Childhood Ed
B.S., Warner Pacific
M.S., Eastern Oregon University

Angela Christman (2008)
Instructor of Nursing
A.A.O.T., Blue Mountain Community College
B.S., Oregon Health Sciences University

Timothy D. Colley (2004)
Instructor of English
B.A., Gonzaga University
M.A., Gonzaga University

Jennifer K. Cooper (2004)
Instructor of Psychology
A.A., Central Oregon Community College
B.S., Western Oregon University
Psy. D., Pacific University

Roger Cooper (2004)
Instructor of English
B.S., Portland State University
M.S., University of Denver
Ed.D., Oregon State University

John Courtney (2006)
Instructor of Criminal Justice
B.A., Cal State University Long Beach
M.Pa., City University

Sarah Crane-Simpson (2011)
Instructor of Education
B.S., University of Idaho
M.Ed., University of Idaho

Maureen Crossley (2010)
Instructor of Business Technology
A.A., Blue Mountain Community College
B.S., Eastern Oregon University
M.Ed., Eastern Washington University

Brigitte Davis (2010)
Instructor of Communications
B.S., Walla Walla College
M.S., University of Washington

Cheyleen Davis (2001)
Instructor of Biology
B.S., Central Michigan University
M.S., Central Michigan University

Julie Denny (2011)
Instructor of Criminal Justice
B.S., Eastern Oregon University
M.S., Capella University

Christopher Doss (2011)
Instructor of English
B.A., Oregon State University
M.A., University of Colorado
M.F.A., Brown University
M.A.T., Oregon State University

Cami Eastep (2010)
Instructor of Psychology
A.A., Walla Walla Community College
B.A., Western Oregon University
M.A., Seattle University

Karen Eddy (1993)
Instructor of Physical Education
B.S., Eastern Oregon University

Dianne Ellingson (2003)
Instructor of English
B.A., Augustana College
M.S., Eastern Oregon University

Daniel Emert (2010)
Instructor of Music
A.A., Mt. Hood Community College
B.S., Western Oregon University

Shawn Eng (2011)
Instructor of Physical Ed
Diploma, Heppner High School

Robert English (2010)
Instructor of Civil Engineering
A.A.S., Blue Mountain Community College
Registered Professional Land Surveyor

Heather Estrada (2006)
Instructor of Mathematics
B.A., Concordia University

Carol Faulkner (2007)
Instructor of English
B.S., Kent State University
M.A., Kent State
Ph.D., University of Oregon

Alan Feves (2010)
Instructor of Music
B.A., Whitman College

Kent Fisher (2003)
Instructor of History
B.A., Eastern Oregon University
J.D., University of Oregon

Mark Ford (2008)
Instructor of Apprenticeship
Certificate, Oregon State Apprenticeship and
Training Council

Jimmie Ford (2011)
Instructor of Welding
Welding Certificate Columbia Basin College

Ruai Gregory (2000)
Instructor of Early Childhood Education
A.S., Grossmont College
B.A., Pacific Oaks
M.A., Pacific Oaks

Theron Hall (2008)
Instructor of Welding

Michelle Hansen (2011)
Instructor of Biology
B.S., Eastern Oregon University
M.S., Portland State University

Jodie Harnden (1997)
Instructor of Geology and Geography
B.S., Western Oregon University
M.S., Western Oregon University

Thomas Harrison (2011)
Instructor of Mathematics
B.S., Oregon State University
M.S., Colorado State University

Donald R. Hefner (2005)
Instructor of Business Technology
B.S., Black Hills State

Jamie Heim (2010)
Instructor of Education
B.A., southern Adventist University
M.Ed., Grand Canyon University

Randal Hennen (2008)
Instructor of Biology
B.S., Black Hills State University
M.S., Texas Tech University

Ryan Hildebrandt (2012)
Instructor of Business Technologies
B.S., Eastern Oregon University
M.B.A., Eastern Oregon University

Sumner Hill, Jr. (2005)
Instructor of Apprenticeship

Jan Hood (1988)
Instructor of Computer Science
A.A., Blue Mountain Community College
A.S., Blue Mountain Community College
B.S., Oregon Institute of Technology
M.M.R., University of Georgia

Joyce E. Houle (2006)
Instructor of Education
B.S., Eastern Oregon University

Marvin L House (2005)
Instructor of Mathematics
B.S., Oregon State University/Math
B.S., Oregon State University /Science
M.A., Oregon State University

Sigmund Hoverson (2009)
Instructor of Physical Science
B.S., California Institute of Technology
M.S., University of Washington

Robert Irvine (2007)
Instructor of History
B.A., Whitman College
M.M., Willamette University
Ph.D., Kansas State University

Mardel James-Bose (2000)
Instructor of English
B.A., Portland State University
M.A., Portland State University

Claude Bil Johnson (1999)
Instructor of Apprenticeship
A.A.S., Shawnee State College
B.S., Kennedy-Western University

Jean Johnson (2008)
Instructor of Early Childhood Ed
B.S., Western Oregon University

James R Johnston (2006)
Instructor of Math and Computer Science
B.S., Northern Arizona University
M.B.A., Northern Arizona University

Cathryn Jones (2011)
Instructor of Mathematics
B.S., Texas A&M University
M.S., Texas A&M University

Mark Justice (2011)
Instructor of Business Technology
B.A. George Fox University
M.B.A., Regis University

Ernest Kincaid (2011)
Instructor of Business Technologies
B.A., Southwestern Adventist University
M.B.A., Eastern Oregon University

Alan L. King (2005)
Instructor of Human Development
B.A., Eastern Oregon University
M.A., Walla Walla College

David H. Krumbein (1986)
Instructor of Civil Engineering Technology
B.S., Oregon State University

Cynthia Kuchenbecker (2012)
Instructor of Business Technologies
B.S., Eastern Oregon University
M.T.E., Eastern Oregon University

Carel Landess (2000)
Instructor of Business
A.A., Western Business College
M.P.A., Portland State University

Charles (John) Larson (2003)
Instructor of English
B.A., Concordia
M.A., Eastern Oregon University

Kerri Latshaw (2005)
Instructor of English
A.A., Linn Benton Community College
B.S., Southern Oregon University
M.A., Western Oregon University

Elise Leahy (2009)
Instructor of Nutrition
B.S., University of Oregon
M.S., Portland State University

Ron LeBlanc (2011)
Instructor of Business Technology
B.S., University of Arizona
M.S., University of Arizona

Laura Lee (2008)
Instructor of Spanish
A.A., Central Oregon Community College
B.A., Portland State University
M.Ed., City University

Helen Loennig (2007)
Instructor of Chemistry
B.S., University of Maryland
Phar.D., University of Washington

Carole Mace-Edwards Jones (2001)
Instructor of Early Childhood Ed
B.S., Pacific Oaks College
M.A., SPED University of Oregon

David Marshall (2003)
Instructor of Business Technology
B.A., Whitman College
M.A., Evergreen State College

Carol Martin (2008)
Instructor of Spanish
B.A., Youngstown University
M.A., Western Michigan University

Christine Martin (2008)
Instructor of Physical Education
A.A., Walla Walla Community College

Ryan Marvin (2007)
Instructor of Sociology
B.S., Eastern Oregon University
M.S., Stockholm University

Thomas Mauldin (2011)
Instructor of Physical Education
Diploma, Vacaville HS

Dale McCreary (2003)
Instructor of Biology
B.S., Colorado State University
M.S., Colorado State University

Marcella Monahan (2010)
Instructor of Nursing
B.S.N., Oregon Health & Science University

Kimberly Mosier (2008)
Instructor of Criminal Justice
B.A., University of Oregon
J.D., Lewis & Clark College-Northwestern School of Law

Rockal Newton (2012)
Instructor of Business Technology
B.S., Warner Pacific College

Jerry Nickell (2010)
Instructor of Business Technology
B.S., Loma Linda University
M.A., University of Redlands CA

Aaron Nielson (2010)
Instructor of Business Technology
B.S., Canisius College
MBA, Hawaii Pacific University

Ralph Noe (2008)
Instructor of Diesel Technology
Certified Welder, Northwest Testing Laboratories

Janet Ockerman (2010)
Instructor of Sociology
B.A., Transylvania University
M.A., University of Kentucky

Jeremie Overton (2011)
Instructor of Apprenticeship
Oregon State Journeyman License

Larry Patterson (2011)
Instructor of Physical Education
A.S., Blue Mt Community College
B.S., Washington State University

April Phillips (2011)
Instructor of Business Technology
B.S., Western Baptist College
M.B.A., George Fox University

Kristy Pierson (2011)
Instructor of Business Technology
B.A. Eastern Oregon University
M.A., Eastern Oregon University

Theresa Pihl (1995)
Instructor of History
B.A., University of Portland
M.A., Washington State University

Nancy Prachar (2004)
Instructor of Business Technology
B.A., Austin College
M.B.A., University of Saint Francis

Douglas B. Radke (1993)
Instructor of Speech
B.A., Seattle Pacific University
M.Div., Bethel Theological Seminary
M.A., Portland State University

Virginia Rembold (2011)
Instructor of Physical Ed
B.A., Lewis & Clark College
M.A., Lewis & Clark College

Jay Rogers (2005)
Instructor of Math
B.S., Oregon State University
M.S., Eastern Washington University

Carol Sams (2011)
Instructor of Communications
A.A., Columbia Basin College
B.A., Gonzaga University
M.A., Washington State University

Rima Sanders (2006)
Instructor of Criminal Justice
B.S., Eastern Oregon University
M.S., Michigan State University

Katie Saul (2012)
Instructor of Business Technology
B.S., Eastern Oregon University
MBA, Eastern Oregon University

Lynn Seaman (2008)
Instructor of Business Technology
B.S., Oregon State University
M.Bus.Ed., Oregon State University

Michael Shaw (2001)
Instructor of Social Science
B.A., Eastern Washington University
M.A., Gonzaga University

Fred Sheely (1992)
Instructor of Computer Science
B.A., University of Idaho
M.A., University of Oregon

Kenneth Simpson (2005)
Instructor of Science
B.S., Los Angeles College

Andrew Skinner (2005)
Instructor of Apprenticeship

Michelle Snyder (2009)
Instructor of Biology
B.S. Montana State University
M.S., Montana State University

Jonathan Spilker (1995)
Instructor of Physical Science
B.S., Eastern Oregon University

Mark Stansbury (2005)
Instructor of Accounting
B.A., Concordia College
M.A., Creighton University

Pamela Steele (2008)
Instructor of English
B.S., Austin Peay State University
M.F.A., Spalding University

Roxanne Stephens (2008)
Instructor of Nursing
A.D.N., Blue Mountain Community College
B.S.N., Oregon Health Sciences University

Susan Stephens (2010)
Instructor of Nursing
A.A.S., Blue Mountain Community College

Delores Swearingen (2010)
Instructor of Business Technology
A.A., Blue Mt Community College

Alden Taylor (2007)
Instructor of Music
B.M., Willamette University
M.M., University of Oregon

Robin Terjeson (2010)
Instructor of Science
B.S., Eastern Oregon University
M.S., Portland State University

G Ann Thomas Heddle (2004)
Instructor of Writing
A.A., Blue Mountain Community College
B.A., Eastern Oregon State College
M.A., Eastern Oregon State College

Kristen Thompson-Graber (2009)
Instructor of Psychology
B.S., Eastern Oregon University
M.A., Walla Walla College

Jamie Thurmond (2011)
Instructor of Education
A.A.O.T., Clackamas Community College
B.S., Western Oregon State College

Jim Timmons (2010)
Instructor of Business Technology
B.A., University of Washington
MBA, Washington State University

Stanley Ben Titus (2010)
Instructor of Business Technology
B.S., Eastern Oregon University

Lorna Tonack (2002)
Instructor of Spanish
B.S., Whitman College
M.S., Eastern Oregon University

Josephine Topholm (2009)
Instructor of Art
B.S., Eastern Oregon University
M.F.A., Washington State University

Barry Trapp (2010)
Instructor of Computer Science
A.A., Spokane Falls Community College
B.A., Eastern Washington University
M.S., University of Oregon

Myrna Van Cleave (2008)
Instructor of Music
A.R.C.T., University of Toronto-Royal
Conservatory of Music

Sharon Wachter (2011)
Instructor of Communications
B.A., Walla Walla University
M.A., Loma Linda University

Clifford Wakeman (2011)
Instructor of Philosophy
B.A., University of California, Davis
M.A., San Francisco State University

Krys Wallace (2010)
Instructor of Chemistry
B.S., University of Wisconsin
Ph.D., University of Massachusetts

Ronald W. Wallace (1983)
Instructor of Mathematics and Computer
Science
B.A., Azusa Pacific College
M.S., California State Polytechnic University

Terry Warhol (2011)
Instructor of Civil Engineering Tech
A.S., Umpqua Community College
B.S., Oregon Institute of Technology
M.S., Oregon State University

Daviyonne Weathersby (2012)
Instructor of Physical Education
B.S., California State University

Shawn White (2011)
Instructor of History
B.S., University of Idaho
M.S., Eastern Oregon University

Elizabeth Woodiwiss (2008)
Instructor of Music
A.A., Blue Mountain Community College

Roman Yoder (2011)
Instructor of Business Technology
B.S., University of State of New York
M.P.A., University of Central Florida

Kathryn Youngman (2010)
Instructor of Spanish
B.A., University of Oregon
M.S., Portland State University

Tracy Yun (2010)
Instructor of Business Technology
A.D.N., American Rivers College
MSN, Rush University

Timothy Zacharias (2004)
Instructor of History
A.A., Judson Baptist College
B.A., Oregon State University
M.A., Washington State University
Teacher Certificate, Portland State University

Luke Zwanziger (2011)
Instructor of History
B.A., Hanover College
M.L., University of Glasgow

College Preparatory Programs

Full-Time Faculty

Brian K. Bradley (2001)
Instructor
B.A., University of Montana

Marianne I. Burch (2001)
Instructor
B.S., Western Oregon University
M.A., Golden Gate Baptist Theological
Seminary

Tamara L. Chorey (2001)
Instructor
A.A., Oakland Community College
B.S., Oregon State University

Cheryl Haertling (2005)
Instructor
B.A., California State University

Greg Jones (2005)
Instructor
B.A., Oregon State University
M.A., Oregon State University

Doreen Matteson (2001)
Instructor
B.S., Virginia Polytech University

Shannon Maude (2001)
Instructor
B.A., Southern Oregon University
Ed.M., Oregon State University

Sharone McCann (1985)
Instructor
B.A., California State University
Ed.M., Oregon State University

Dulcie Peterson (2003)
Instructor
A.A., Blue Mountain Community College
B.A., Eastern Oregon University

Catherine Pinkerton (1991)
Instructor
B.A., Whitman College

Bri Lynn Reed (2004)
Instructor
A.A., Blue Mountain Community College
B.S., Eastern Oregon University

Carrie J. Swanson (1991)
Learning Disabilities Diagnostician
A.A., Blue Mountain Community College
B.S., Eastern Oregon University
M.T.E. Eastern Oregon University

Sandra Vandever (2001)
Instructor
A.A.O.T., Blue Mountain Community College
B.S., Eastern Oregon University
M.T.E., Eastern Oregon University

Jason C. Villers (2001)
Instructor
A.A., Spokane Falls Community College
B.A., Eastern Washington University

Sirpa S. Whitman (2002)
Instructor
A.A., Sacramento City College
B.A., Portland State University
T.E.S.L., Portland State University
M.A., University of Oregon
M.P.A., University of North Carolina

Jeanine Youncs (2007)
Instructor Special Education
AAOT, Blue Mountain Community College
B.S., Eastern Oregon University

Part-Time Faculty

Sandra Brost (2008)
Instructor
A.A., Blue Mountain Community College
B.S., Eastern Oregon University

Cathy Currey (2010)
Instructor
B.S., Oregon College of Education

Ann Dennis (2006)
Instructor
B.S., Eastern Oregon University

Amy Hayes (2009)
Instructor
A.A.O.T., Blue Mountain Community College
B.S., Kaplan University

Mary Holdman (2008)
Instructor
B.A., Eastern Washington University

Sandra Holtz (2007)
Instructor
B.A., University of Oregon

Carol Johnson (2010)
Instructor
B.A., University of Oregon
M.T.E., Eastern Oregon University

Ingrid Larsen (1996)
Instructor
B.S. Brigham Young University

Amalee Lindquist (2000)
Instructor
B.S., Western Oregon University

Rhonda Lineberger (2010)
Instructor
B.A., University of Idaho
M.Ed., Northwest Nazarene College

Ricardo Martinez-Dominguez (1999)
Instructor
Conalep College-Morelia, Mexico Centro
Mexicano Internacional

Carol J. Nevin (1991)
Instructor
B.A., University of Montana

Katherine Palmer (2000)
Instructor
A.S., Blue Mountain Community College
B.S., Eastern Oregon University
M.S., Oregon State University

Brenda Paul (2010)
Instructor
A.S., Lane Community College
B.S., Eastern Oregon University
M.A., Walla Walla University

Diane Pearson (2002)
Instructor
B.A., Albertson's College of Idaho
Ed.M., Wichita State University

Amanda Pugh (2002)
Instructor
B.S., University of Oregon
M.L.S., University of Oregon

Elizabeth Shane (2007)
Instructor
B.S., Western Oregon University
M.S., Walden University

Linda M. Stark (1994)
Instructor
A.A., Glendale College
B.A., University of California-Berkley

Diana Stroe (2004)
Instructor
B.S., Eastern Oregon University

Directors, Coordinators, and Managers

Casey Beard (2012)
Director of Grants
B.A., Washington State University
M.A., Salve Regina College
M.A., Naval War College

Rebecca Blaine (2009)
Coordinator, Criminal Justice
B.A., California State University
M.A., State University of New York

Jennifer Bostwick (2008)
Coordinator, Community Education
EMT-Paramedic, Northwest Medical Training
Institute

Theresa Bosworth (1989)
Registrar/Director of Admissions, Records and
Testing
A.A., Blue Mountain Community College
B.S., Eastern Oregon University

Katrina Bretsch (2010)
Interim Director College Prep
A.A. Blue Mountain Community College
B.S., Eastern Oregon University

Brett Bryan (1993)
Athletic Director
B.S. Eastern Oregon University

Margaret Gianotti (2006)
Executive Director, BMCC Foundation
Diploma

Diana Hammon (1989)
Director, Instructional Operations
A.A., Blue Mountain Community College
B.S., Eastern Oregon University

Rheadean Hays (2009)
Coordinator, Early Childhood Education
A.S., Olympic Community College
B.S., Central Washington University

Jennifer Hills (1994)
Director, Apprenticeship Program
B.S., University of Idaho
M.Ed., Eastern Washington University

Rhonda Holcomb (2008)
Interim Controller /
Senior Operations Accountant
A.A.S., Linn-Benton Community College

Jan Hood (1988)
Coordinator, Institutional Research
A.A., Blue Mountain Community College
A.S., Blue Mountain Community College
B.S., Oregon Institute of Technology
M.M.R., University of Georgia

Virginia Justice (2012)
Coordinator, CASE Grant
B.A., Central Washington University

Jane Kilburg (1981)
Manager, JOBS Program
B.S., Oregon State University

Anne Livingston (2008)
Outreach Coordinator
B.S., Washington State University
M.B.A., Eastern Oregon University

Ashley Masterson (2010)
Coordinator, Grant County
B.S., Eastern Oregon University
M.S., Boise State University

Naamah Franke (2004)
Coordinator, BMCC Hermiston/Boardman
B.A., Eastern Washington University

Anne Morter (1993)
Coordinator, South Morrow County
A.A., Lane Community College
B.A., Eastern Oregon University

Wade Muller (2005)
Assistant Director, Advising Testing and
Student Disability Services
B.S., Montana State University

Steven Platt (1985)
Supervisor, Buildings and Grounds
A.S., Blue Mountain Community College

Donna Richardson (2005)
Director, TRiO Student Support Services
Program
B.S., University of Wyoming
M.A., University of Wyoming

E. Karl Schrader (2004)
Manager, BMCC Bookstore
B.A., University of Washington

Cristina Sweek (1996)
Director Student Financial Assistance
A.A., Blue Mountain Community College

Jacque Talboy (2001)
Coordinator, Publications and Graphic Design
Diploma, Camelback High School
CRT, HTT ASP

Robert Tally (1996)
Info Systems Administrator & Analyst
CRT, NRI Schools

Shannon Van Kirk (2006)
Director, Library and Media Services
B.A., Immaculate Heart College
MLIS University of Alabama

Glossary

Terms Needed for College Success

A.A.O.T.: Associate of arts Oregon transfer degree. A *non-designated* block transfer degree, usually consisting of 90 credits and designed for the student who intends to transfer to a four-year college or university with the Oregon University System (OUS). *Students need to work closely with an academic advisor to plan their program of study at BMCC.*

A.A.S.: Associate of applied science degree. A non-transfer degree awarded to students who complete the requirements of a two-year program, usually a 93-credit designated program as outlined in the college catalog.

A.S.: Associate of science degree. A non-designated college-transfer degree designed for students whose program requirements do not fit A.A.O.T. degree patterns. This degree does not always “block transfer” to Oregon universities.

A.G.S.: Associate of general studies degree. A terminal, two-year, 90-credit program of study that yields a non-designated and non-transferring degree, although some, or possibly all, of the courses may be accepted by another institution of higher education.

(In every case above, students should verify course transferability for each program of study before transferring to another college or university. Even in Oregon, particular schools may have some differences in lower division credits required for their programs.)

Academic Advisor: An assigned BMCC faculty or staff member trained to assist the student in developing and managing the completion of the student’s program of study based on the documented assessments and declared educational goals within the student’s individual educational plan.

Academic Calendar: Start and end dates of the academic year and of each quarter. The calendar reflects deadlines and other information related to payment schedules, add/drop options, graduation applications, and related policies.

Academic Records: The official listing of courses attempted and completed by a student at BMCC, including the credits accepted as a result of the BMCC registrar’s evaluation of official transcripts from other institutions. This information is listed in the student management module of the integrated administrative system, WolfTrax, and is accessible to the student through WolfWeb.

Academic Year: The four-quarter sequence beginning in summer and ending the following spring.

Academic Notification of Warning, and Suspension: An official process by which degree-seeking students who do not achieve satisfactory academic progress receive a specific level of notice whenever their term grade point average (GPA) falls below 2.00 or their cumulative GPA falls below 2.00.

Advanced Placement (AP): The national exam for high school students that allows the granting of credit based on points earned and recorded on the official AP transcripts. Earned points of 4 and 5 are considered evidence that the student has mastered the equivalent of an introductory course in English or history at BMCC or other various other subject matters.

Articulation: The linkage of curriculum between two (or more) institutions through an agreement that the content and difficulty level of similar courses offered by each institution are equivalent and that students taking the articulated course at one institution will not need to repeat it when they transfer to the other institution.

Associate’s Degree: A degree granted to students who complete a specific program of study usually totaling 90 quarter credits or more. BMCC offers two transferable associate’s degrees, the associate of arts Oregon transfer (A.A.O.T.) and the associate of science (A.S.). BMCC also offers an associate of general studies (A.G.S.) degree and an associate of applied science (A.A.S.) degree, as well as module and certificate programs in a variety of subjects. Individual courses taken to fulfill the requirements of any of these degrees or programs may be transferable to another college or university.

Audit: Taking a credit class without being required to participate fully in the class activities (taking tests or doing homework). Classes taken under audit status do not count as credits attempted in financial aid calculations, and the AU status does not count in calculating GPAs.

BMCC Campus: BMCC’s main campus is located in Pendleton.

BMCC Center: Within the Blue Mountain Community College system, four outreach centers serve the college’s district, which includes Baker, Morrow, and Umatilla counties. Centers are located in Baker City (Baker County), Boardman (north Morrow County), Hermiston, and Milton-Freewater. A smaller office in Heppner serves south Morrow County.

Certificate Program: A specified program of study leading to an official award and notation on the transcript. BMCC awards certificates to students who complete certain career and technical or postsecondary programs requiring less than two years of college study and who earn a GPA of no less than a 2.00, or C average.

Class Roster: The official list of students' names enrolled in a particular class.

Cohort: A group, regardless of size, of individuals that can be identified by at least one identifiable characteristic.

College Preparatory Programs: A BMCC department administering classes and activities related to English as a second language (ESL), adult basic education (ABE), general educational development (GED), adult high school diploma (AHS), credit retrieval, post-secondary remediation up to the 60 level, and tutoring.

Competency: A specific skill in a specific area of study.

Contracts Out Of District (CODs): Within the Blue Mountain Community College service area, there are two counties (Grant and Wallowa) that lie outside the BMCC district but that contract with the college for educational services. BMCC has COD offices in John Day and Enterprise.

Corequisite: A course or activity that is required to be taken simultaneously with the course described.

Core Curriculum: Courses required for a specific major. Courses in the core curriculum usually must be taken for a grade (pass/no pass is not allowed) to count toward degree requirements.

Course/Class: An organized unit of instruction within an academic discipline or subject of study, or one of the instructional subdivisions of a discipline or subject area.

Course Description: The paragraph in the course catalog that describes a course's emphasis and content; the description also may specify prerequisites, corequisites, recommended preparation, and credit hours.

Credit: A measurement of course work and time spent in an academic endeavor. One credit generally equates to fifty minutes (a clock hour) of instruction and two hours of preparatory work outside the instructional classroom each week, or the equivalent thereof. Credits and clock hours may vary depending upon the type of course.

Credit Load: The total number of credits taken in a given term.

CUESTE (pronounced "quest"): Curriculum of Undergraduate Elementary and Secondary Teacher Education. CUESTE is a highly prescriptive teacher-education program at Eastern Oregon University (EOU) provided to students within their local community college districts in collaboration with the community college.

Curriculum: An organized program of study.

CWE: Cooperative work experience. CWE is a program of study in a work environment for which students, instructors, and participating businesses develop written training and evaluation plans to guide student development within specific programs. Students receive course credit for their work experience, whether or not they are paid a wage.

Designated Degree: A set of courses required for a specific degree in a career and technical area. The A.A.S. degree is the only designated degree offered at BMCC.

Distance Education: The delivery of instruction to students located throughout the district, state, nation, and the world using a variety of technologies and telecommunications networks. Delivery systems include interactive television (ITV), video recorded instruction, online instruction, guided instruction, and hybrid courses.

Drop: The process of removing one's name from the class roster within the 100-percent refund period for a course or courses. This procedure results in a full refund. After a drop, there is no record of the student's having ever registered for the class and no grade is reflected on the transcript.

Electives: Courses that students may choose to take, as contrasted with courses that are required for an academic program.

Emphasis: A concentration or specialization within a program or academic option that provides additional curricular focus. *An emphasis does not appear on a transcript except in the A.A.S. degree and certificate programs.*

English as a First Language (EFL): Used primarily in a college preparatory setting to denote students whose native language is English.

English as a Second Language (ESL) or English Language Learner (ELL): Terms that denote students or a program for students who want to improve their English language proficiency in order to perform effectively in an academic, work, or community setting. Many college preparatory classes are structured specifically for ESL and ELL students.

Enrollment: The placement of a student within a credit or non credit course. Enrollment and registration are interchangeable terms from a student standpoint. From an institutional standpoint, registration is the process of enrollment and enrollment is a status.

Enrollment Management (EM): The college's administrative unit consisting of the following functions: admissions, records and testing; advising; financial aid and veterans' benefits; student employment; services for students with disabilities; recruitment and marketing; and the TRiO Student Support Services grant-funded program. In addition, the Associated Student Government reports to the associate vice president of enrollment management. The EM offices provide services to students in such areas as: official grades and transcripts; degree, credit, and transfer-transcript audits; international student services; academic achievement recognition; issuance of diplomas; satisfactory academic progress; student safety; student dispute resolution; student orientation; student success strategies; and emergency loans and other forms of financial assistance.

Ethnic/Racial Group: An ethnic or racial category with which a person most closely identifies. Federal and state regulations require BMCC to report aggregated ethnic/racial information and other demographic statistics for its employees and students. The categories listed on federal reports are: American Indian/Alaskan Native, Asian/Pacific Islander, Black, Hispanic, and White. BMCC ethnic/racial reports also include "unknown" and "not reported" categories for students who may be of mixed race or heritage and do not identify with or select any of the categories as listed, who choose not to respond to the query, or who check "unknown" or "not reported" on the data collection form. These ethnic categories do not include international students, who are reported separately.

Faculty: The group of employees whose primary assignment is instructional support of the academic mission.

FAFSA: The federal form entitled "Free Application for Federal Student Aid." A completed FAFSA is required for students to be considered for federal financial aid. It is available in hardcopy from BMCC or at a local high school. It is also available online.

Financial Aid Package: A combination of financial student-support mechanisms (such as a scholarships, grants, loans, and work-study) determined by the BMCC Office of Financial Aid and Veterans' Benefits.

First-Generation College Student: Defined at BMCC as a student whose parents have not earned an associate's degree or higher. Defined by the federally funded TRiO-Student Support Services program as a student whose parents have not earned a bachelor's degree or higher.

First-Time Freshman: A student with fewer than 45 credits who has enrolled for the first time in college.

Foundational Requirements: Refer to General Education Requirements.

Full-Time Student: A student enrolled in 12 or more credits during any one term as of the FTE (full-time equivalent) reporting date established by the Oregon Community College Unified Reporting System (OCCURS). Definitions for financial aid and veterans' services programs may vary.

General Education (Gen. Ed.) Requirements: Courses in the conventional divisions of arts and humanities, social sciences, and math and science that provide students with a broad educational experience. General education courses are typically introductory in nature and provide students with fundamental skills and knowledge. Students seeking an A.A.O.T. or an A.A.S. degree from BMCC and/or planning to transfer to a four-year academic institution often take these required courses while attending a community college in preparation for successful transition as a junior in pursuit of their baccalaureate degree.

Grade: A mark indicating a degree of academic accomplishment.

Grade Point Average (GPA): A computation of work done at BMCC and at other academic institutions. Grade points are computed on the basis of: 4 points for each credit of A, 3 points for each credit of B, 2 points for each credit of C, 1 point for each credit of D, and 0 points for each credit of F or FA. All assigned courses, regardless of curriculum, are included in the BMCC cumulative grade point average. To compute your GPA, take the number of points for your grade, multiply them by the number of credits for that class (for example, if you received an A for a four-credit class, you would have a total of 16 points), and divide the total points by total credits. All marks except A, B, C, D, F and FA are disregarded in the computation of grade point averages; however, some of these disregarded marks will affect financial aid and athletic eligibility. *Honors GPA and graduation are calculated differently (see below).*

Grant: An award of student financial support that *does not require repayment and is based on financial need*.

Honors: An official recognition of students with exceptional academic qualifications; such students may graduate with honors or high honors. For honors designation, students must have a cumulative GPA of 3.40 to 3.84 in all courses that meet degree requirements. The high honors designation requires a cumulative GPA of 3.85 or higher in all courses that meet degree requirements. The cumulative GPA calculation will include all courses taken at BMCC and other institutions as long as they apply to the degree requirements.

Hybrid Course: A class that uses multiple presentation options, such as a combination of interactive television (ITV) and videotapes.

Individual Strategic Action Plan (ISAP): The collection of assessment information and data for an individual degree-seeking student that drives the decisions involved in declaring a program of study and defining educational goals. The ISAP is used in conjunction with the expertise and advice of the student's assigned academic advisor.

In-State Resident: As defined for tuition purposes, a U.S. citizen or national whose primary residence is in Oregon, Washington, Idaho, Wyoming, Nevada, Montana, or California.

Interlibrary Loan Service (ILL): A service provided by the Library and Media Services Center through which BMCC's centers and students, as well as the general public, may obtain materials on temporary loan from other libraries nationwide.

International Student: As defined for tuition purposes, a person who is not a citizen or a national of the United States and who is in this country temporarily and specifically to obtain a postsecondary educational degree. BMCC assesses an international student the same rate of tuition as a student who is classified as a nonresident alien; an international student pays the same amount for fees and books as any other student.

Junior: Usually defined by four-year institutions as a student with 90 quarter credits of 100-level or higher course work.

Kiosk: A computer work station made available by BMCC to students for accessing the WolfWeb and all online resources.

Major: An extensive program of study in a designated subject area offered at four-year institutions; students seeking a bachelor's degree must declare a major and complete all of its requirements. There are no majors offered at BMCC.

Matriculation: Advancing through the educational process toward a goal, particularly related to enrolling in a college or university (for example, upon completing the A.A.O.T. degree at BMCC, a student may to matriculate to Eastern Oregon University).

Minor: A field of specialized study secondary to a major that may be offered by an academic unit at a four-year institution. There are no minors offered at BMCC.

Non-Credit Enrollment: Course offerings in which no credit is awarded for completion; non-credit courses often serve to upgrade skills, maintain licensure, or gain personal enrichment.

Non-Designated Degree: A set of courses fulfilling general education requirements for a transfer degree leading to a baccalaureate degree or for the associate of general science degree, which offers a broad education as opposed to a focused or career study program.

Nonresident Alien: A term used for tuition purposes to define a person who is not a citizen or a national of the United States and who is in this country on a temporary basis and does not have the right to remain indefinitely. The tuition rate for a nonresident alien is different from the resident tuition rate, but a resident alien student pays the same amount for fees and books.

Non-Traditional Student: A student in credit classes or developmental education classes not fitting the traditional student definition.

Online Supplemental Instruction: Additional teaching and learning opportunities in English and Spanish that are offered through the Internet in support of the basic instructional activities of a particular course.

Oregon Transfer Module: A one-year program of study through which a student can complete most, but not all, general education requirements before transferring to a public four-year institution in Oregon.

Orientation: An activity for students that is intended to acquaint them with campus resources and thereby better prepare them for successful learning and navigation within the educational system.

Out-of-State Resident: A term used to assess tuition for a student who is a U.S. citizen or national whose primary residence lies outside Oregon, Idaho, Washington, Nevada, Montana, or California.

Outcome: A term used at BMCC and at other institutions that defines institutional expectations and academic standards. Student-learning outcomes are specific statements defining the expected understanding, knowledge, and/or skill-set that a successful student will have obtained upon completing a course. All course syllabi at BMCC list expected student-learning outcomes.

Part-Time Student: For most purposes at BMCC, and consistent with national definitions, a degree-seeking student who is enrolled in fewer than 12 credit hours in a term as of the FTE (full-time equivalent) reporting date established by the Oregon Community College Unified Reporting System (OCCURS). Definitions for the financial aid and veterans' services programs may vary.

Peer Tutor: A trained student who works with fellow students to provide, at no additional cost to the recipients, additional instruction in course work that he or she has completed with a grade of B or better.

Placement Test: An assessment of academic preparedness that helps place a student into a specific course addressing the particular skill level identified by the test. BMCC uses placement tests in math, reading, and writing to help ensure a student's success in college.

Preregistration: Allows students to register before the beginning of classes each term. Students should be in good academic standing and have no outstanding financial balance due from a previous term; otherwise they may be prevented from enrolling in classes or be removed from classes until such obligations are met.

Prerequisite: A course or instructional program that students are expected to complete successfully as a necessary requirement before they are permitted to enroll in another course or instructional program that is more advanced.

Quarter: Synonymous with the academic period often called a term at BMCC. There are four quarters in an academic year, beginning with the summer quarter and ending with the following spring quarter.

Registration: The placement of a student within a credit or non credit course. Enrollment and registration are interchangeable from a student standpoint. From an institutional standpoint, registration is the process of enrollment and enrollment is a status.

Resident: For tuition purposes, a student whose primary residence is in Oregon; residents are charged in-state tuition. At BMCC, students who reside in Idaho, Washington, Nevada, Montana, and California are also considered residents.

Resident Alien: A person who is not a citizen or national of the United States and who has been lawfully admitted for permanent residence (and who holds alien registration receipt cards Form I-551/155). A resident alien is assessed tuition at the same rate as a citizen or national of the United States.

Scholarships: Financial support mechanisms awarded to students based on merit or merit plus need. Scholarships may require that recipients meet certain conditions such as term credit load or progress toward degree: they do not have to be repaid.

Sequence Courses: Two or more closely related courses in a discipline or subject area, taken in a specified order using chronological numbering.

Sophomore: A student who has completed 45 or more credit hours.

Staff: The category of employees whose primary assignment is administrative support of the academic mission.

Student Identification Number (SID): A unique, official identification number randomly issued by the college for each BMCC student that is used to record, access, and store academic records.

Subject Code: An alphabetical abbreviation used with a course number to indicate an academic subject area, such as MTH for math courses.

Supplemental Instruction: Face-to-face or online teaching and learning opportunities offered by instructors in addition to and in support of the classroom experience.

Syllabus: An outline of a particular course offering that communicates the course's content, learning objectives, and expected performance criteria for student grades.

Term: An academic quarter.

Traditional Student: A student who is between the ages of 18 and 22 years old taking credit-bearing courses and who has received a high school diploma.

Transcripts: The official record of courses and grades attempted or completed by a student. *Official transcripts* must be ordered by the student from an academic institution's enrollment management office. *Transfer transcripts* are records from another school that BMCC uses for admission purposes or for evaluating a student's earned credits that may be accepted toward a program of study at BMCC. Students requesting transfer transcripts from another institution must arrange to have those transcripts sent directly to BMCC's Office of Enrollment Management in order for those transcripts to be considered official and to be used in assessing credits already earned. *Unofficial transcripts* from BMCC are available online through the student's account.

Transition: The process of a student's successful fulfillment of declared educational goals and his/her subsequent advancement to another endeavor as a result of completing those goals. Transitions may occur, for example, from one academic level to the next, from a study program to a job, or from one institution of higher education to another.

TRiO Student Support Services: A federally funded student-support program that provides services to help eligible students succeed in college. The project serves first-generation, low-income, or disabled students who are seeking a college degree and who hold U. S. citizenship.

Tuition and Fees: The total mandatory charges assessed students for enrolling in the institution each term.

Tutor: A person with expertise in specific subject areas to assist students in understanding concepts taught in the classroom. Tutors are available free to the students at most BMCC locations, though they may be available to help only in specific academic areas.

Withdraw: The process of filing the required paperwork when a student abandons an attempt to earn the credits associated with a given course. Both the course and a grade of W appear on the student's transcript. The grade of W is not calculated for GPA; however, a W may affect a student's financial aid. Students withdrawing from classes do not receive a refund of tuition or fees.

WolfTrax: BMCC's software system that manages the college's academic activities, records, procedures, and processes.

WolfWeb: The Internet-based resource that provides BMCC students online access to all of their BMCC information.

BMCC Pendleton
2411 N.W. Carden Avenue

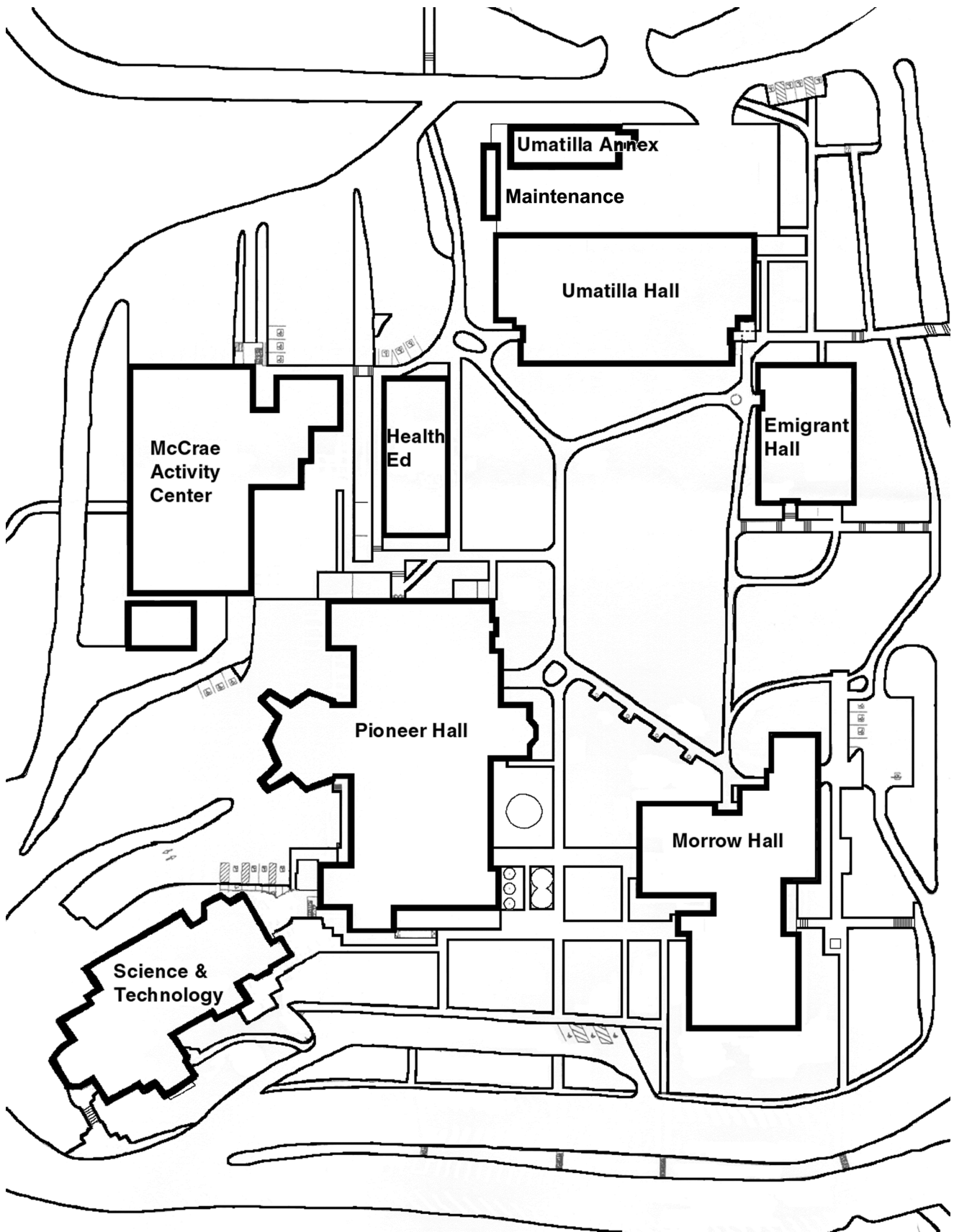

BMCC Pendleton Building Maps

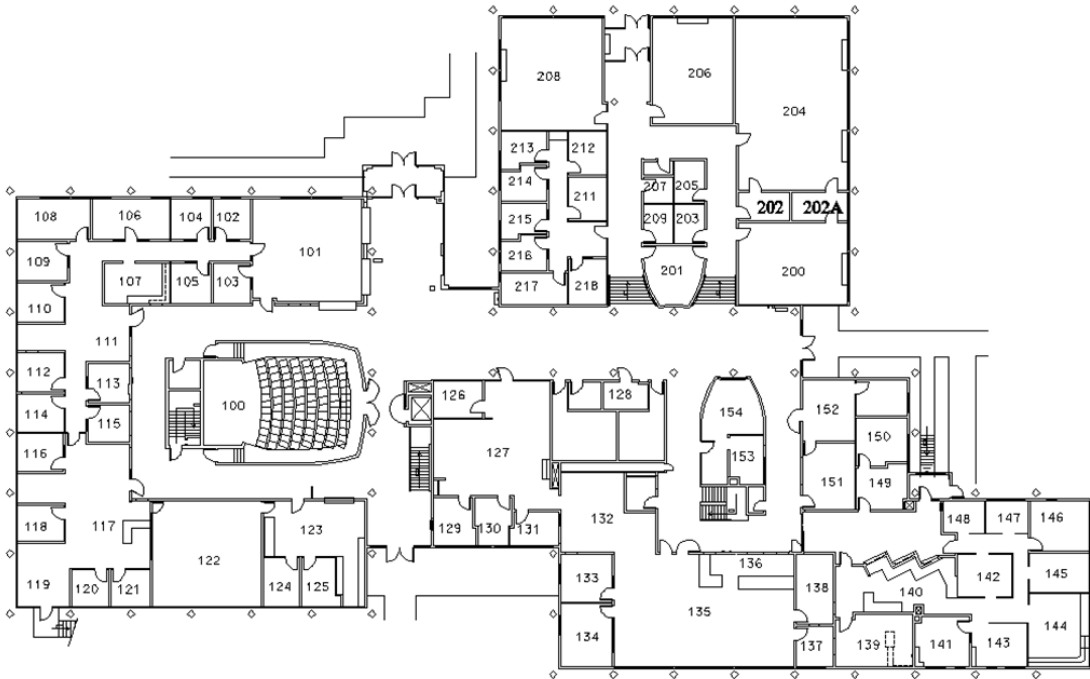

**MORROW HALL
Main**

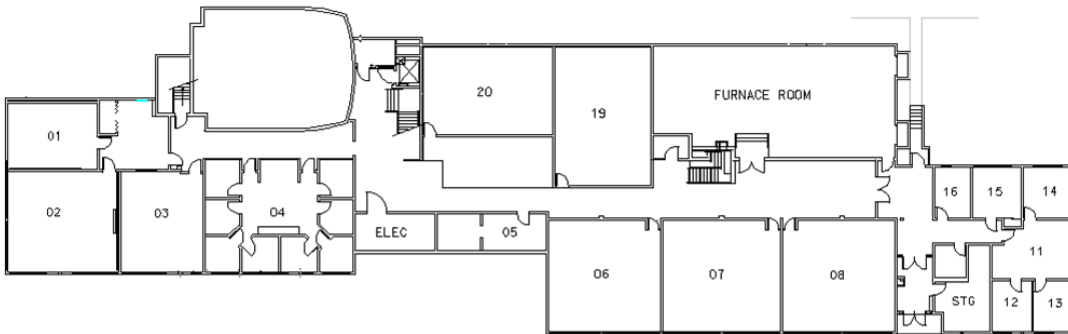

**MORROW HALL
Lower**

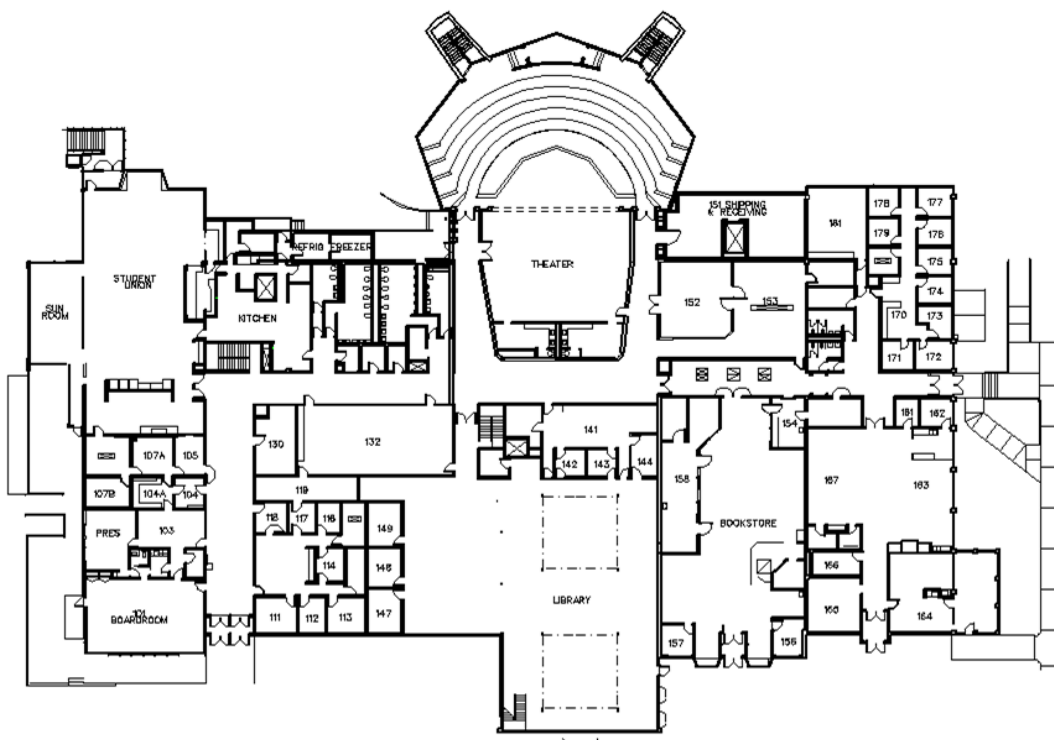

PIONEER HALL

BMCC Pendleton Building Maps

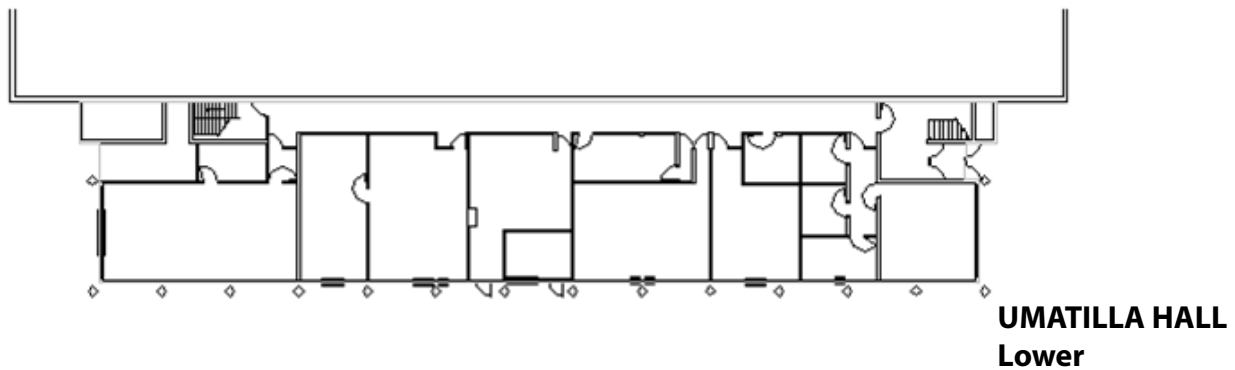
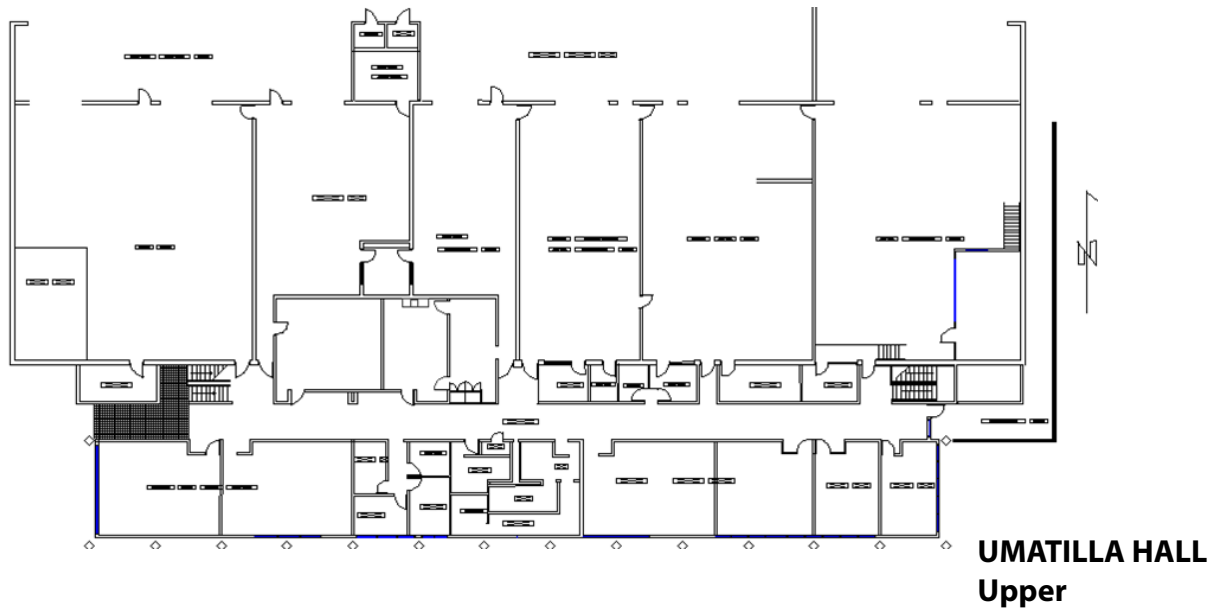
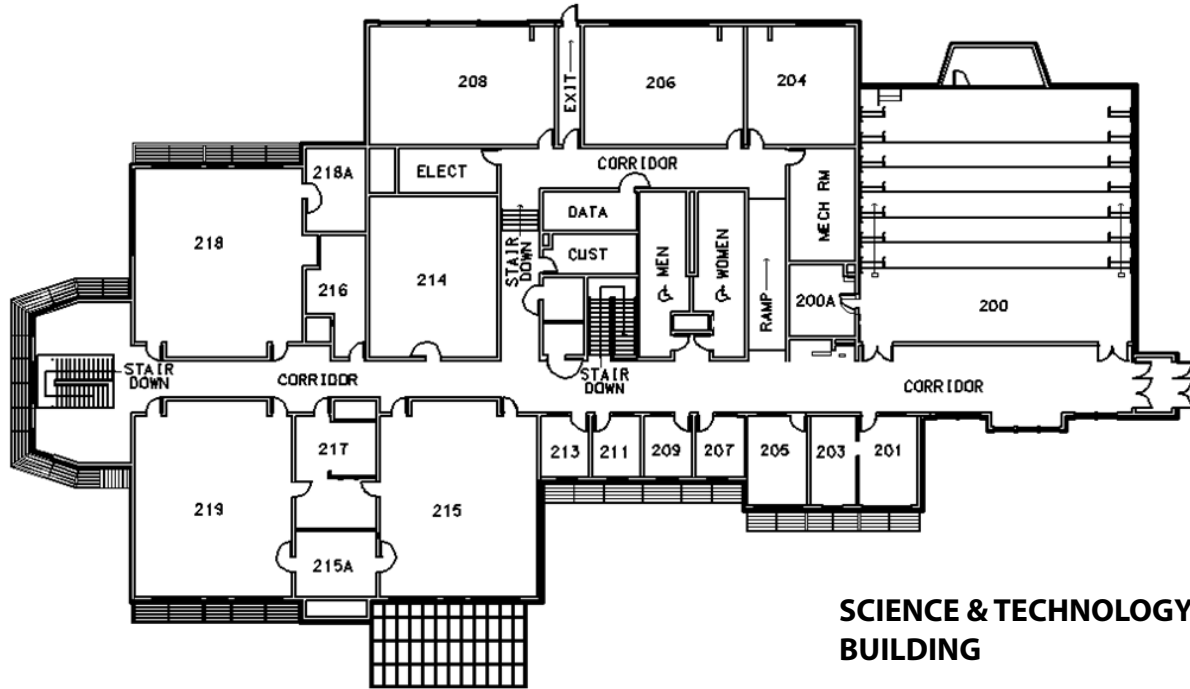

BMCC Pendleton Building Maps

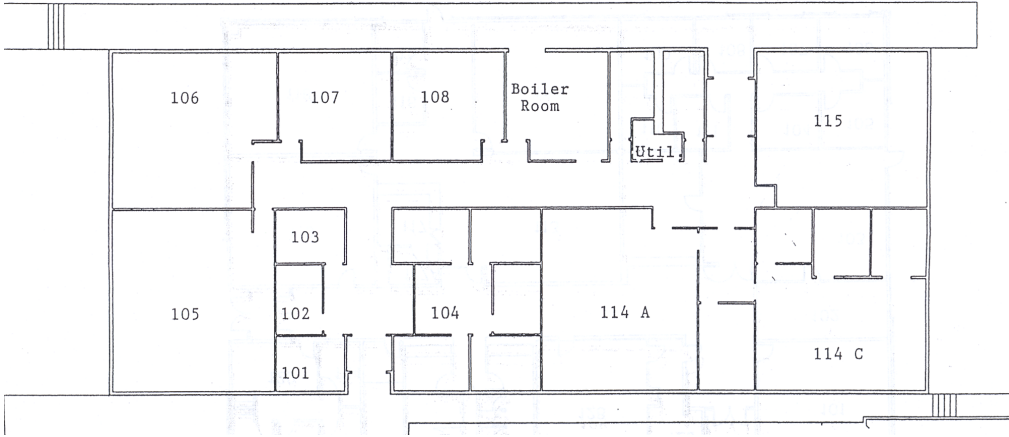

HEALTH BLDG

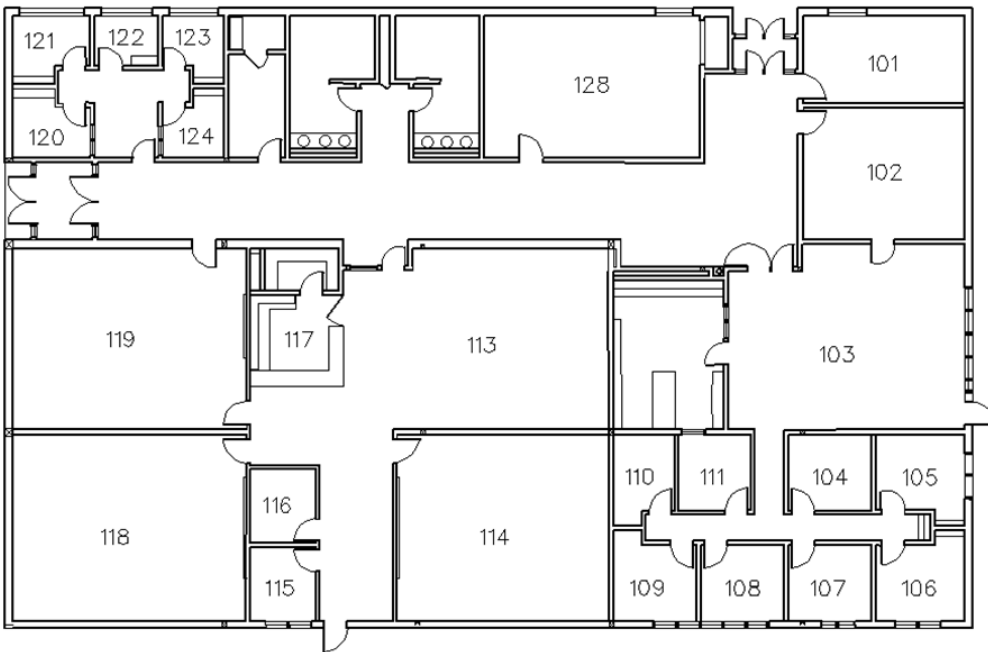

EMIGRANT HALL

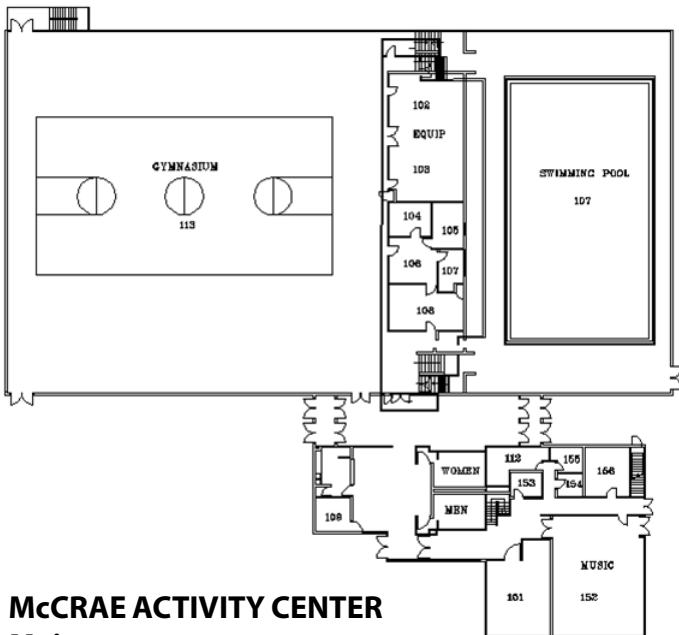

**McCRAE ACTIVITY CENTER
Main**

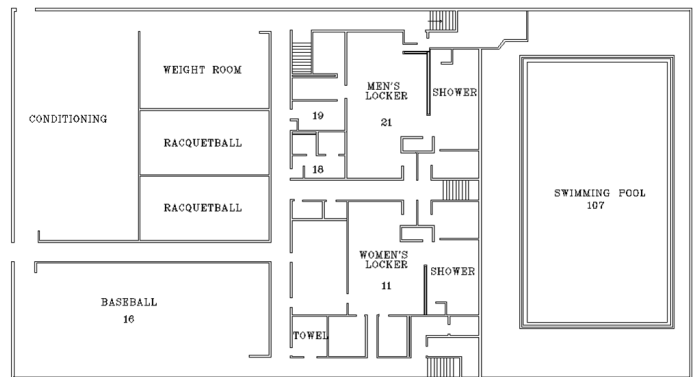

**McCRAE ACTIVITY CENTER
Lower**

BMCC Hermiston - EOHEC

980 S.E. Columbia Drive

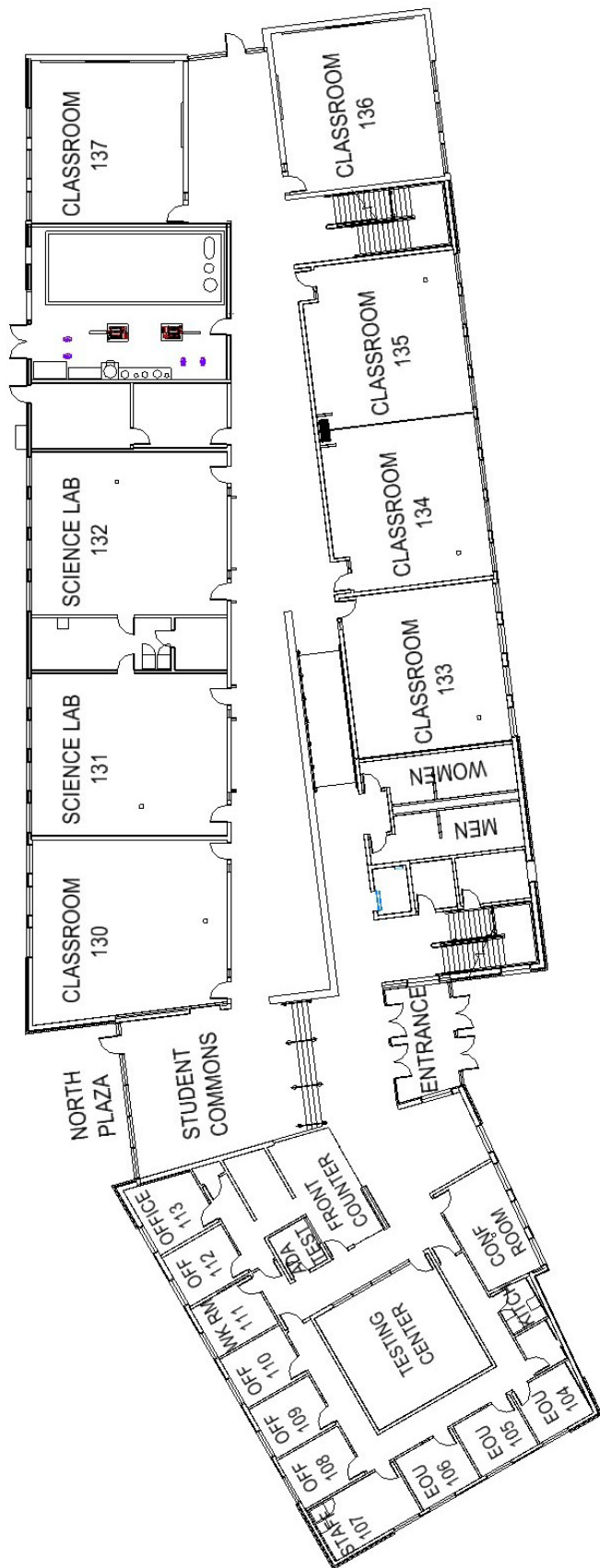

FIRST FLOOR

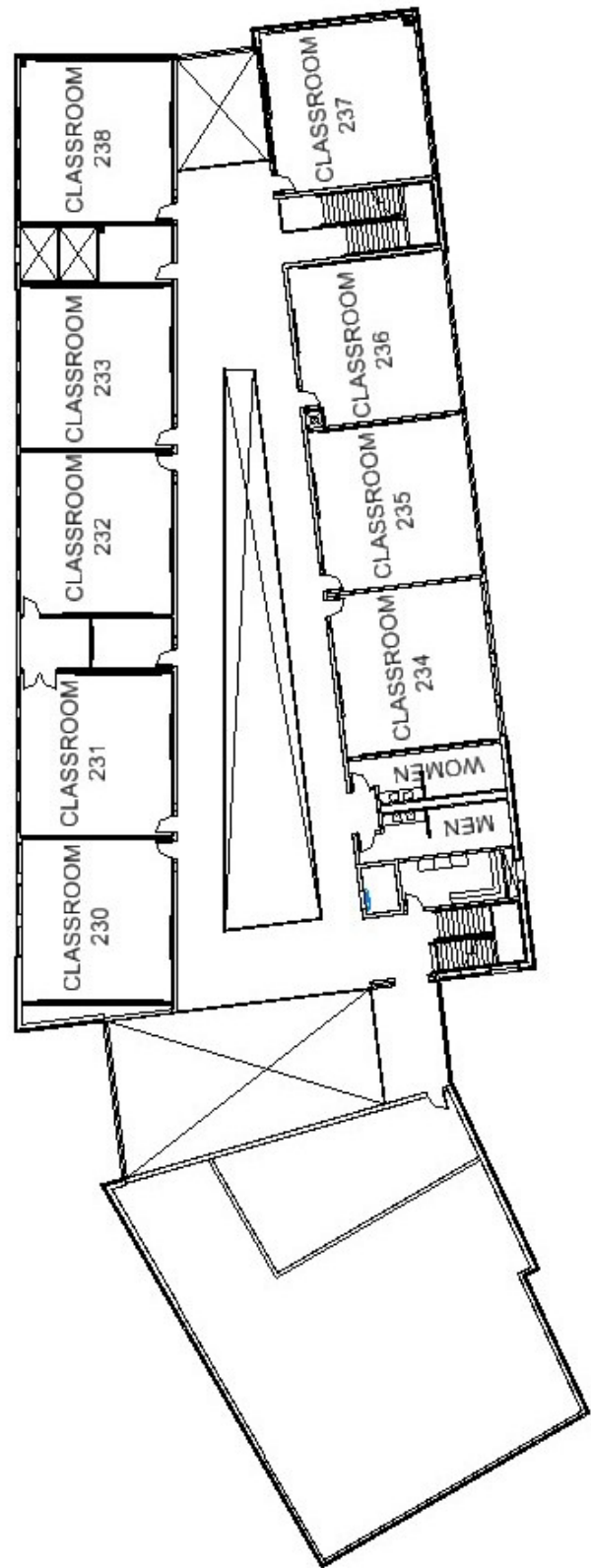

SECOND FLOOR

BMCC Hermiston - Columbia Hall
980 S.E. Columbia Drive

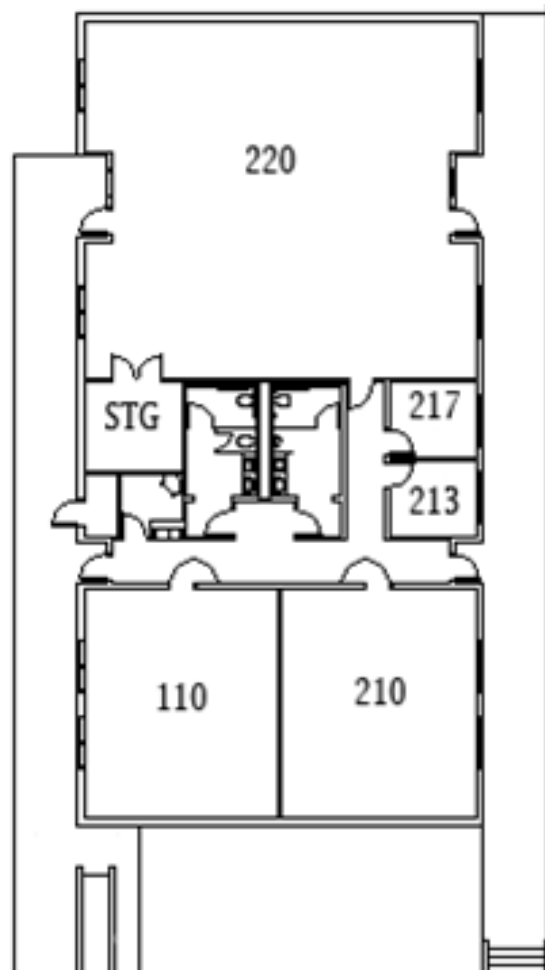
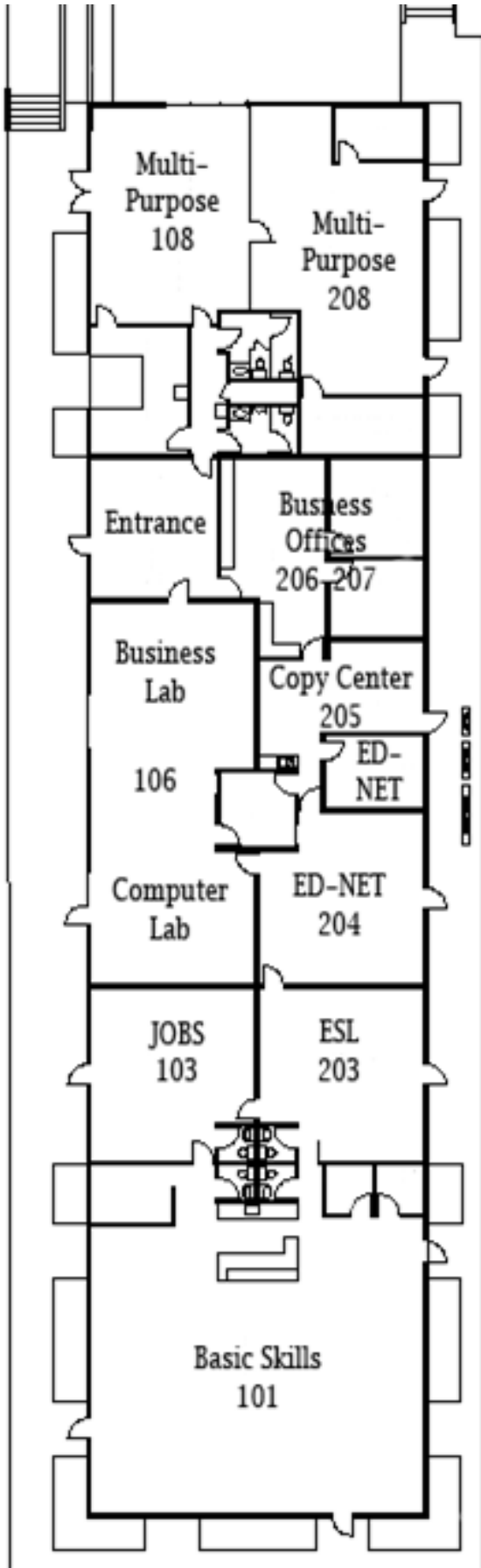

**BMCC Milton-Freewater
311 N. Columbia**

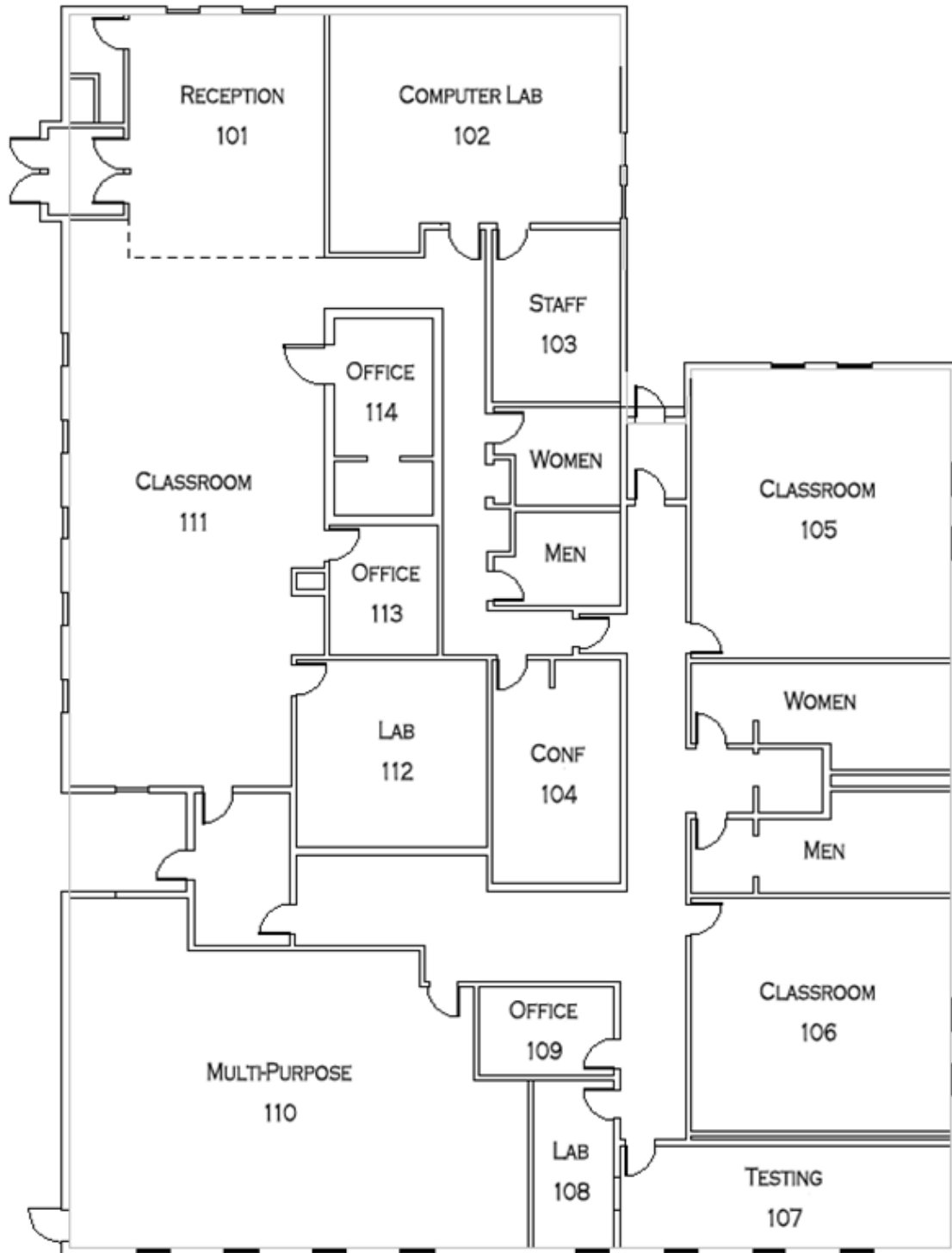

**BMCC Baker City
3275 Baker Street**

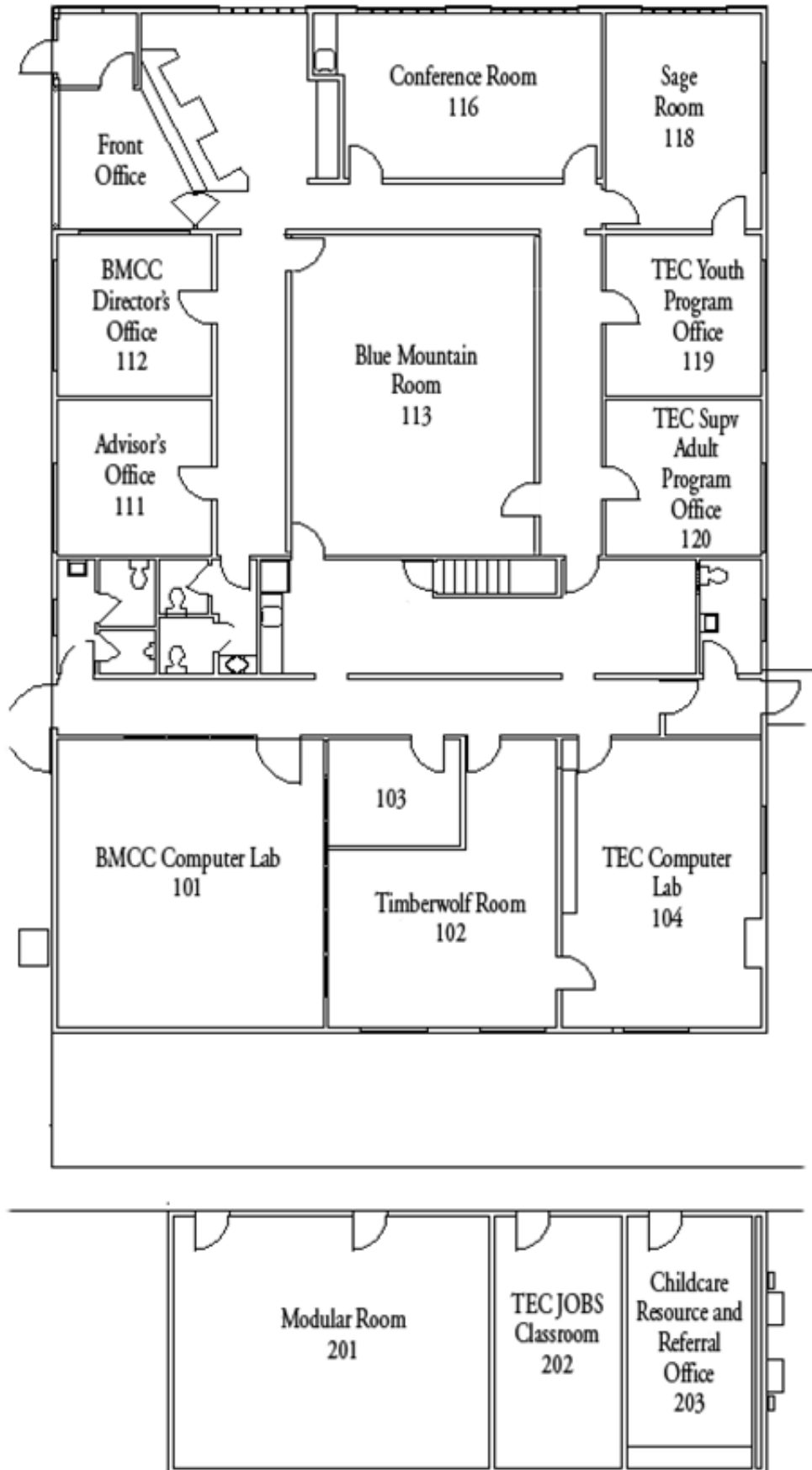

BMCC Phone Directory

(Area Code: 541)

BMCC Services

Admissions	278-5759
Advising	278-5931
Ambassadors	278-5936
Art Gallery, Betty Feves	278-5952/5944
Athletics	278-5900/5896
Bookstore	278-5733
Box Office (Theater)	278-5953
Business Office	278-5744
Computer Services / Help Desk	966-3182
Cooperative Work Experience	278-5969/5763
Copy Center	278-5966
CTUIR / Tribal Liaison	278-5935
Disability Services	278-5958
Distance and Extended Learning	.278-5763/5969
Enrollment Management	278-5760
EOU Distance Education	.278-5776/5778
Financial Assistance to Students	278-5759
Food Services	278-5946
Foundation	278-5775/5930
Grants	278-5838/5930
Human Resources	278-5837/5947
Inclement Weather Information	278-5970
Instruction, Office of	278-5930
Library	278-5915
Maintenance	278-5903/5904
Marketing	278-5936/5962
Public Relations	278-5951
McCrae Activity Center	278-5900/5896
OSU Extension Office	278-5403
Operations	278-5154
President's Office.	278-5951
Recruitment (Student)	278-5936
Registrar	278-5757
Room Scheduling	278-5969
Service Center	278-5759
Small Business Development Center, Pendleton	278-5833
Student Employment	278-5165
Student Government Office/Student Activities	278-5948
Student Learning Center	278-5965
TDD Hearing Impaired Hermiston	564-9248
Pendleton	278-2174
Testing	278-5931
Theater Box Office	278-5953
TRiO Student Support Services	278-5853/5852
Tutoring	278-5965
Veterans' Assistance	278-5165
Weather Closure Information	278-5970
Web Coordination	278-5962

Academic Departments

Agriculture	278-5868
Apprenticeship	278-5854
Business Technologies	278-5868
Civil Engineering Technology	278-5868
College Preparatory Programs.	278-5803/5795
Computer Science	.278-5877
Dental Assisting	278-5877
Diesel Technology	278-5748
Early Childhood Education	278-5957
Education	278-5802
English	278-5944
Fine Arts	278-5944
Mathematics	278-5877
Nursing	278-5877
Physical Education	278-5896
Science	.278-5788
Social Science	278-5944

BMCC Location-Specific Services

BMCC Baker County	523-9127 or 276-1260 ext. 3201
BMCC Grant County	575-1550
BMCC Hermiston	567-1800 or 276-1260 ext. 3303
BMCC Milton-Freewater	938-4082 or 276-1260 ext. 3171
BMCC Morrow County - Boardman	481-2099
BMCC Morrow County - Lone	422-7040
BMCC Wallowa County	426-4109
College Preparatory Programs	
Baker City	523-9127
Boardman	481-2099
Hermiston	567-6615
Milton-Freewater	938-4082
Pendleton	278-5803
JOBS Programs	
Hermiston	567-1800 ext. 3322
Milton-Freewater	938-4082 ext. 3172
Pendleton	276-9050 ext. 229
SBDC, Hermiston	564-9021, ext. 3341
Community Corrections Education	276-7824 ext. 249
Eastern Oregon Correctional Institution (EOCI Ed.)	278-7102
Powder River Correctional Facility (PRCF Ed.)	278-7102
Two Rivers Correctional Institution TRCI Ed.)	922-6135

2012-2013 Academic Year Calendar	Summer Term 2012	Fall Term 2012	Winter Term 2013	Spring Term 2013
Advising Begins	Apr 16	Apr 16	Oct 8	Jan 28
Registration Begins	May 7	May 21	Nov 5	Feb 25
Classes Begin	Jun 25	Sep 24	Jan 7	Apr 1
Last Day to Add a Class	NEW AS OF SUMMER 2012 – SEE CHART IN 2012/2013 ACADEMIC CATALOG			
Last Day Drop a Class with a Full Refund (dates vary for differentially scheduled classes)	Jun 28	Sep 28	Jan 11	Apr 5
Last Day Deferred Payment Plan Offered w/o Late Fee	Jun 28	Sep 28	Jan 11	Apr 5
Last Day to Pay Tuition <u>Before</u> a Late Fee is Assessed 3% of unpaid balance with a minimum charge of \$10 and a maximum charge of \$75 per term. Fees assessed monthly until paid.	Jun 28	Sep 28	Jan 11	Apr 5
Graduation Application Due	Mar 2	Mar 2	May 4	Nov 15
Last Day to Withdraw from Class	Last day of classes before finals begin	Nov 30	Mar 15	Jun 7
Events		Welcome Back BBQ Constitution Day	Check Web Calendar	Spring Fling In May
Holidays and Campus Closures	Closed Fridays Jun 18 – Aug 31 Independence Day July 4	Labor Day Sept 3 Round-Up Sept 14 Faculty & Staff Professional Development Sept 17-18 Veterans Day Nov 11 Thanksgiving Nov 22-23 Winter Break (no classes) Dec 24-Jan 1	New Years Day Jan 1 Martin Luther King Day Jan 21 Spring Break (no classes) Mar 25-29 Spring Break Campus Closed Mar 29	Memorial Day May 27 Summer Break (no classes) Jun 17-21
Final Examinations	6 week courses: Jul 30 - Aug 2 10 week courses: Aug 27 - 30 Check syllabus for dates	Dec 3 - Dec 6	Mar 18 - Mar 21	Jun 10 - Jun 13
End of Term	Aug 30	Dec 7	Mar 22	Jun 14
Commencement				Jun 14



Blue Mountain
Community College

www.blueecc.edu